

Hold	Skive	Susanne Pihl	
550	13	NyVest Skytteforening	LIG
50 meter afsnit 2		Landsstævne 2017	Aalborg Skyttekreds
Prøve		1: 10.6x ↗ 2: 10.3 ↘ 3: 10.8x ↗ 4: 9.7 ↘ 5: 9.6 ↘ 6: 10.5x ↘ 7: 10.3 ↘ 8: 10.4 ↗ 9: 10.1 ←	1. Serie Ligg
		Serie 88.0 Total 0.0	 1: 10.1 ↗ 2: 10.3 ↗ 3: 10.5x ↘ 4: 10.3 → 5: 10.5x ↗ 6: 10.1 ↘ 7: 10.4 ↘ 8: 10.6x → 9: 10.6x ← 10: 9.2 ←
			Serie 99.0 Total 99.0
2. Serie Ligg		1: 9.9 ← 2: 10.8x ← 3: 10.6x ↘ 4: 9.9 ↘ 5: 10.4x ↙	Prøve
		Serie 48.0 Total 147.0	 1: 10.3 ↗ 2: 10.4 ↘ 3: 10.0 ↘ 4: 10.3 ↗ 5: 10.6x ↘
			Serie 50.0 Total 147.0
3. Serie Ligg		1: 10.3 ← 2: 10.7x ↗ 3: 10.7x ↘ 4: 10.7x ← 5: 10.3 ↙	4. Serie Ligg
		Serie 50.0 Total 197.0	 1: 10.6x ↗ 2: 10.1 ↘ 3: 9.8 ↗ 4: 10.8x → 5: 10.8x ↘
			Serie 49.0 Total 246.0
5. Serie Ligg		1: 10.6x ↑ 2: 9.5 ← 3: 9.8 ↗ 4: 10.3 ↘ 5: 10.2 ↗	
		Serie 48.0 Total 294.0	

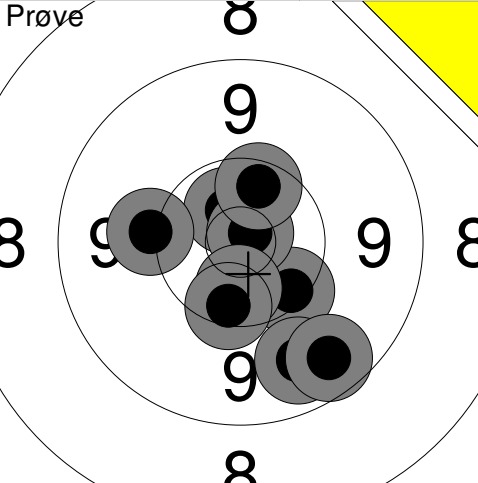

1:	8.0	↑
2:	9.2	↑
3:	9.7	→
4:	9.8	↘
5:	10.3	↑
6:	9.8	↘
7:	9.6	↘
8:	10.2	↘
9:	10.7x	→
10:	9.3	↘
Serie		92.0
Total		0.0

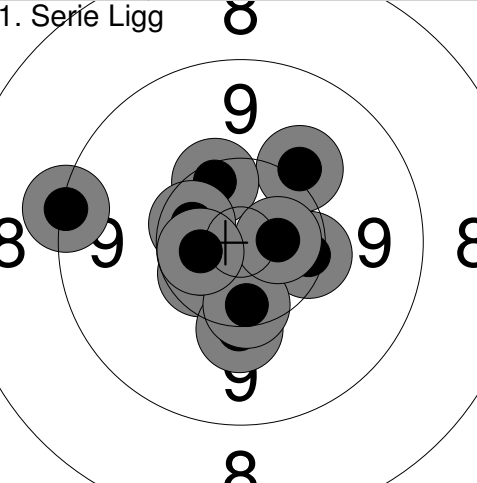
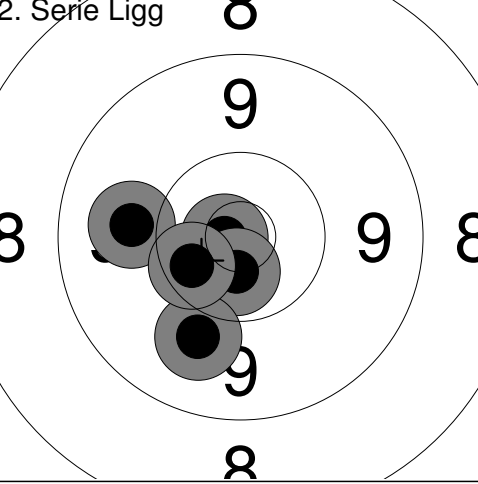
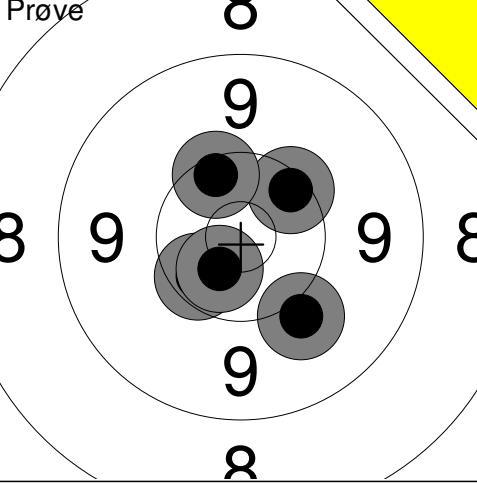
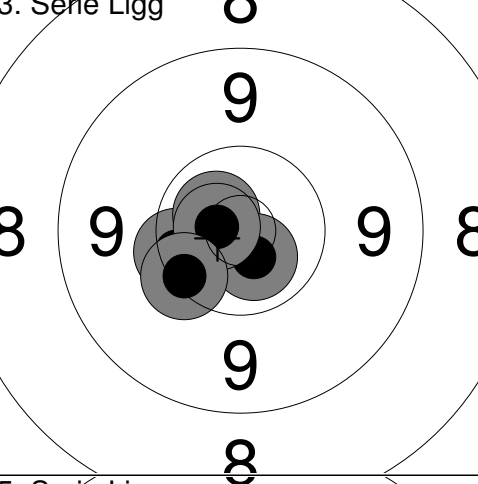
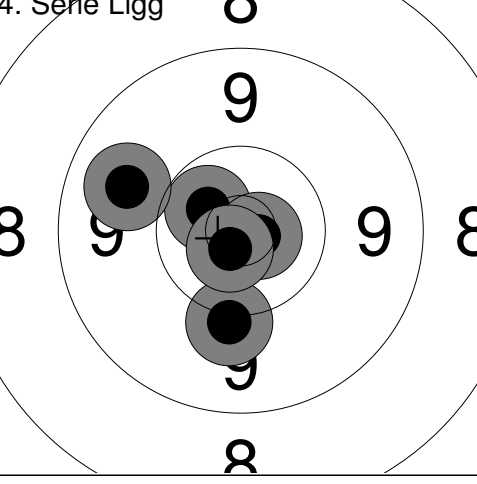
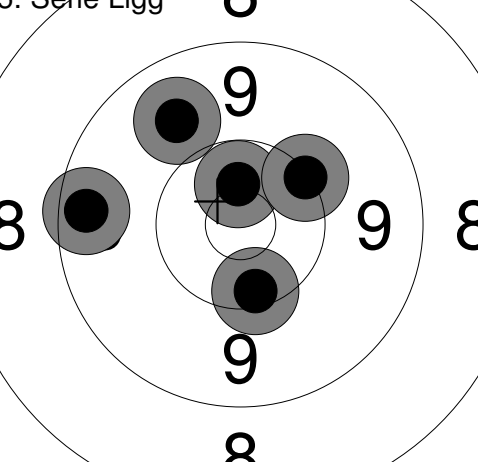
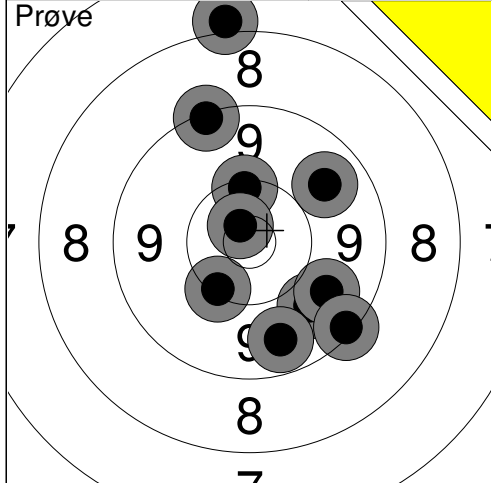
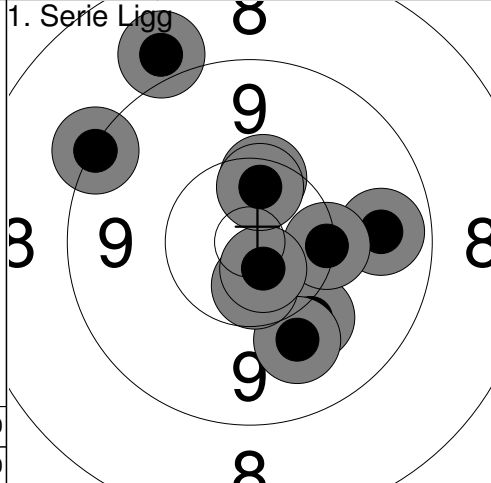

1:	10.0	↘
2:	9.7	→
3:	10.2	→
4:	9.9	↘
5:	8.9	↑
6:	9.2	↗
7:	10.5x	↘
8:	10.3	↑
9:	10.7x	↘
10:	10.4x	↑
Serie		95.0
Total		95.0

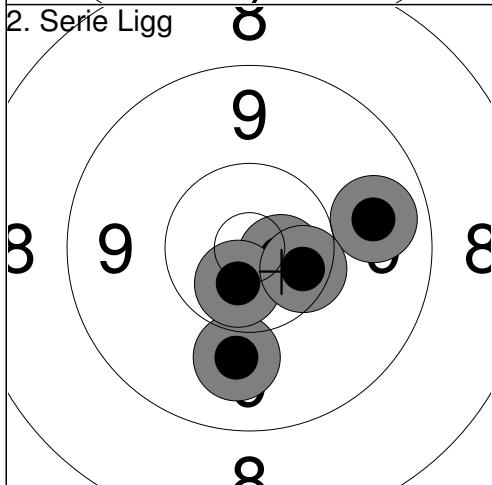

1:	9.7	→
2:	10.6x	↘
3:	9.9	↘
4:	10.6x	↘
5:	10.4	→
Serie		48.0
Total		143.0

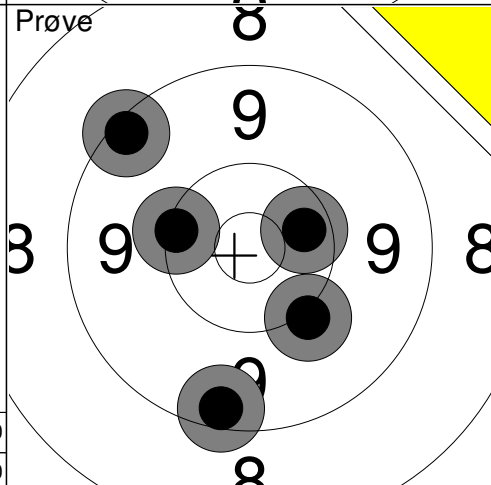

1:	9.3	↗
2:	10.4x	→
3:	9.4	↘
4:	10.1	↘
5:	10.2	↖
Serie		48.0
Total		143.0

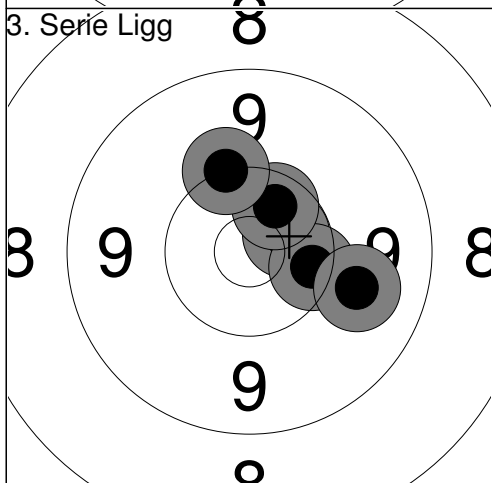

1:	10.6x	↗
2:	10.3	→
3:	10.5x	↗
4:	10.2	↗
5:	9.9	↘
Serie		49.0
Total		192.0

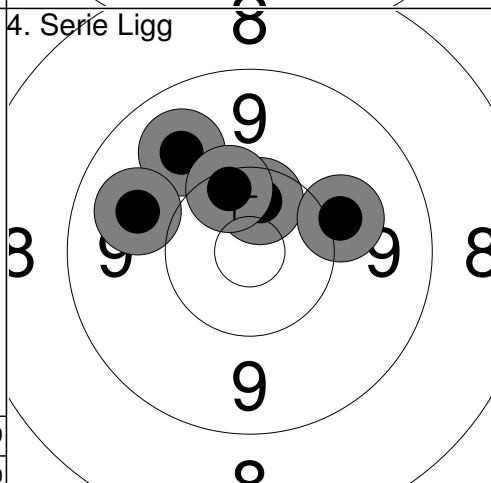

1:	10.5x	↑
2:	10.0	→
3:	9.8	↗
4:	10.3	↗
5:	9.8	↖
Serie		48.0
Total		240.0

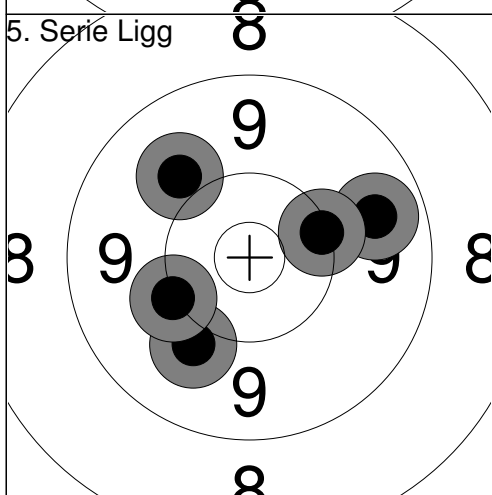

1:	9.7	→
2:	9.9	↗
3:	10.2	→
4:	10.0	↘
5:	10.1	↖
Serie		48.0
Total		288.0

Hold	Skive	Lene Pihl	
550	15	Lene Pihl	
50 meter afsnit 2		NyVest Skytteforening	LIG
		Landsstævne 2017	Aalborg Skyttekreds
Prøve		1: 8.6 ↖ 2: 10.5x ↗ 3: 10.1 ↘ 4: 9.7 ↘ 5: 10.2 ↘ 6: 10.0 ↘ 7: 10.6x ↘ 8: 10.0 ↗ 9: 10.6x ← 10: 10.4x ↑ Serie 97.0 Total 0.0	1. Serie Ligg 1: 10.0 ← 2: 9.6 ← 3: 10.5x ↑ 4: 9.6 ↗ 5: 10.4x ↑ 6: 10.0 ← 7: 10.4x ↗ 8: 10.7x ↗ 9: 10.2 → 10: 9.9 → Serie 97.0 Total 97.0
2. Serie Ligg		1: 10.9x ↘ 2: 10.4 ← 3: 10.2 ← 4: 10.3 ↘ 5: 10.9x ↘ Serie 50.0 Total 147.0	Prøve 1: 10.4 ↓ 2: 10.3 → 3: 10.0 → 4: 10.4 ↑ 5: 10.5x ↗ 6: 10.1 ↗ 7: 10.2 ↗ Serie 70.0 Total 147.0
3. Serie Ligg		1: 10.2 → 2: 10.3 ↘ 3: 10.0 ↗ 4: 10.9x ↘ 5: 9.8 ↗ Serie 49.0 Total 196.0	4. Serie Ligg 1: 10.2 ↑ 2: 10.6x ↑ 3: 10.7x ↘ 4: 10.6x ↗ 5: 10.1 → Serie 50.0 Total 246.0
5. Serie Ligg		1: 10.4 ↑ 2: 9.8 ← 3: 9.6 ↗ 4: 10.5x ↗ 5: 9.9 ↗ Serie 47.0 Total 293.0	

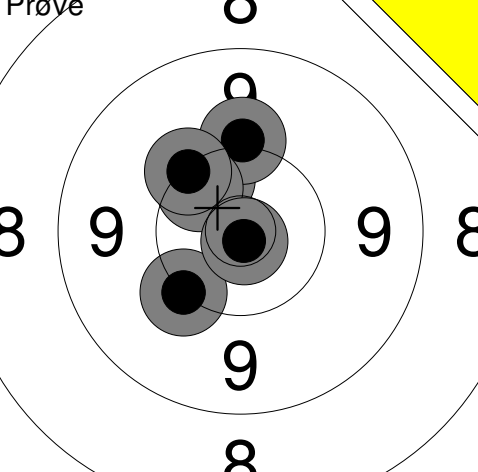
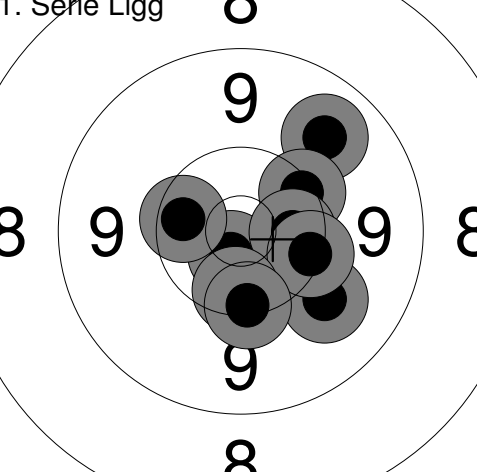
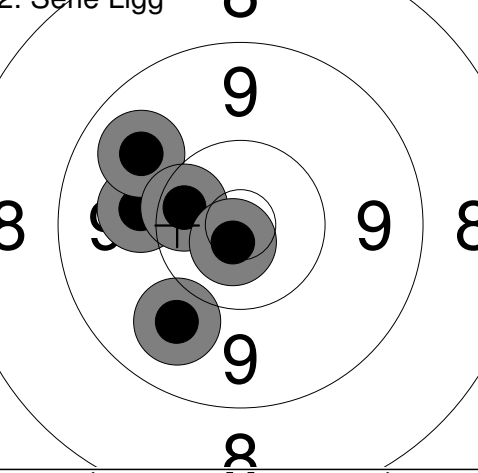
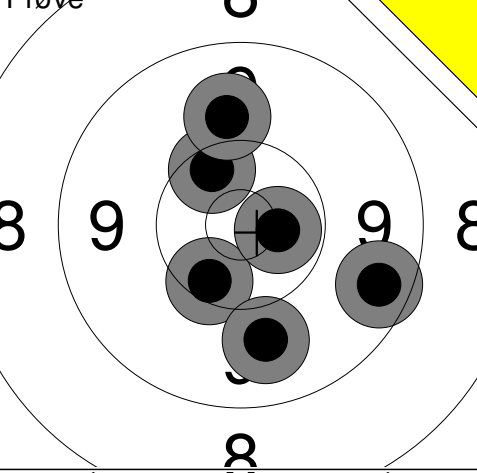
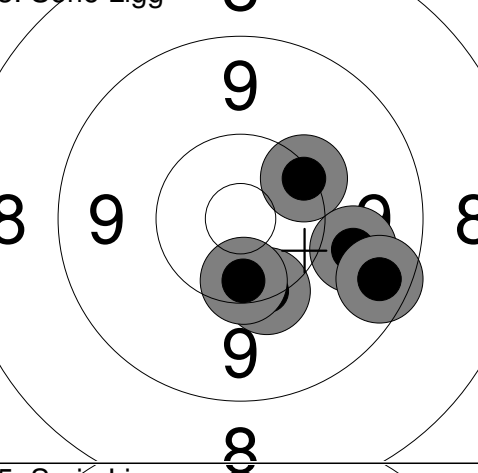
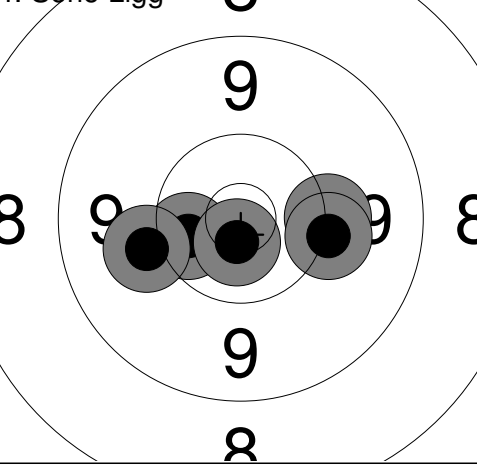
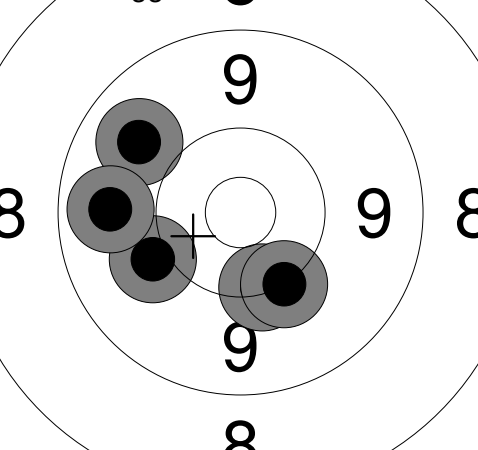

<b>Prøve</b> 	<table border="1" style="width:100%; border-collapse: collapse;"> <tr><td>1:</td><td>10.4</td><td>↗</td></tr> <tr><td>2:</td><td>10.1</td><td>↗</td></tr> <tr><td>3:</td><td>10.4</td><td>↗</td></tr> <tr><td>4:</td><td>10.2</td><td>↗</td></tr> <tr><td>5:</td><td>10.2</td><td>↘</td></tr> <tr><td>6:</td><td>10.9x</td><td>↘</td></tr> <tr><td colspan="2"><b>Serie</b></td><td>60.0</td></tr> <tr><td colspan="2"><b>Total</b></td><td>0.0</td></tr> </table>	1:	10.4	↗	2:	10.1	↗	3:	10.4	↗	4:	10.2	↗	5:	10.2	↘	6:	10.9x	↘	<b>Serie</b>		60.0	<b>Total</b>		0.0	<b>1. Serie Ligg</b>  <table border="1" style="width:100%; border-collapse: collapse;"> <tr><td>1:</td><td>10.4</td><td>↘</td></tr> <tr><td>2:</td><td>10.7x</td><td>↘</td></tr> <tr><td>3:</td><td>9.8</td><td>↗</td></tr> <tr><td>4:</td><td>10.3</td><td>↗</td></tr> <tr><td>5:</td><td>9.9</td><td>↘</td></tr> <tr><td>6:</td><td>10.5x</td><td>→</td></tr> <tr><td>7:</td><td>10.3</td><td>→</td></tr> <tr><td>8:</td><td>10.4</td><td>←</td></tr> <tr><td>9:</td><td>10.4</td><td>↓</td></tr> <tr><td>10:</td><td>10.3</td><td>↓</td></tr> <tr><td colspan="2"><b>Serie</b></td><td>98.0</td></tr> <tr><td colspan="2"><b>Total</b></td><td>98.0</td></tr> </table>	1:	10.4	↘	2:	10.7x	↘	3:	9.8	↗	4:	10.3	↗	5:	9.9	↘	6:	10.5x	→	7:	10.3	→	8:	10.4	←	9:	10.4	↓	10:	10.3	↓	<b>Serie</b>		98.0	<b>Total</b>		98.0
1:	10.4	↗																																																												
2:	10.1	↗																																																												
3:	10.4	↗																																																												
4:	10.2	↗																																																												
5:	10.2	↘																																																												
6:	10.9x	↘																																																												
<b>Serie</b>		60.0																																																												
<b>Total</b>		0.0																																																												
1:	10.4	↘																																																												
2:	10.7x	↘																																																												
3:	9.8	↗																																																												
4:	10.3	↗																																																												
5:	9.9	↘																																																												
6:	10.5x	→																																																												
7:	10.3	→																																																												
8:	10.4	←																																																												
9:	10.4	↓																																																												
10:	10.3	↓																																																												
<b>Serie</b>		98.0																																																												
<b>Total</b>		98.0																																																												
<b>2. Serie Ligg</b> 	<table border="1" style="width:100%; border-collapse: collapse;"> <tr><td>1:</td><td>10.0</td><td>←</td></tr> <tr><td>2:</td><td>9.9</td><td>↘</td></tr> <tr><td>3:</td><td>9.8</td><td>↗</td></tr> <tr><td>4:</td><td>10.4</td><td>↗</td></tr> <tr><td>5:</td><td>10.8x</td><td>↘</td></tr> <tr><td colspan="2"><b>Serie</b></td><td>48.0</td></tr> <tr><td colspan="2"><b>Total</b></td><td>146.0</td></tr> </table>	1:	10.0	←	2:	9.9	↘	3:	9.8	↗	4:	10.4	↗	5:	10.8x	↘	<b>Serie</b>		48.0	<b>Total</b>		146.0	<b>Prøve</b>  <table border="1" style="width:100%; border-collapse: collapse;"> <tr><td>1:</td><td>10.4</td><td>↗</td></tr> <tr><td>2:</td><td>9.9</td><td>↗</td></tr> <tr><td>3:</td><td>9.5</td><td>→</td></tr> <tr><td>4:</td><td>10.4</td><td>↘</td></tr> <tr><td>5:</td><td>9.8</td><td>↘</td></tr> <tr><td>6:</td><td>10.6x</td><td>→</td></tr> <tr><td colspan="2"><b>Serie</b></td><td>57.0</td></tr> <tr><td colspan="2"><b>Total</b></td><td>146.0</td></tr> </table>	1:	10.4	↗	2:	9.9	↗	3:	9.5	→	4:	10.4	↘	5:	9.8	↘	6:	10.6x	→	<b>Serie</b>		57.0	<b>Total</b>		146.0															
1:	10.0	←																																																												
2:	9.9	↘																																																												
3:	9.8	↗																																																												
4:	10.4	↗																																																												
5:	10.8x	↘																																																												
<b>Serie</b>		48.0																																																												
<b>Total</b>		146.0																																																												
1:	10.4	↗																																																												
2:	9.9	↗																																																												
3:	9.5	→																																																												
4:	10.4	↘																																																												
5:	9.8	↘																																																												
6:	10.6x	→																																																												
<b>Serie</b>		57.0																																																												
<b>Total</b>		146.0																																																												
<b>3. Serie Ligg</b> 	<table border="1" style="width:100%; border-collapse: collapse;"> <tr><td>1:</td><td>10.2</td><td>↗</td></tr> <tr><td>2:</td><td>9.8</td><td>→</td></tr> <tr><td>3:</td><td>9.5</td><td>↘</td></tr> <tr><td>4:</td><td>10.2</td><td>↘</td></tr> <tr><td>5:</td><td>10.4</td><td>↓</td></tr> <tr><td colspan="2"><b>Serie</b></td><td>48.0</td></tr> <tr><td colspan="2"><b>Total</b></td><td>194.0</td></tr> </table>	1:	10.2	↗	2:	9.8	→	3:	9.5	↘	4:	10.2	↘	5:	10.4	↓	<b>Serie</b>		48.0	<b>Total</b>		194.0	<b>4. Serie Ligg</b>  <table border="1" style="width:100%; border-collapse: collapse;"> <tr><td>1:</td><td>10.4x</td><td>←</td></tr> <tr><td>2:</td><td>10.1</td><td>→</td></tr> <tr><td>3:</td><td>10.1</td><td>→</td></tr> <tr><td>4:</td><td>10.7x</td><td>↓</td></tr> <tr><td>5:</td><td>10.0</td><td>←</td></tr> <tr><td colspan="2"><b>Serie</b></td><td>50.0</td></tr> <tr><td colspan="2"><b>Total</b></td><td>244.0</td></tr> </table>	1:	10.4x	←	2:	10.1	→	3:	10.1	→	4:	10.7x	↓	5:	10.0	←	<b>Serie</b>		50.0	<b>Total</b>		244.0																		
1:	10.2	↗																																																												
2:	9.8	→																																																												
3:	9.5	↘																																																												
4:	10.2	↘																																																												
5:	10.4	↓																																																												
<b>Serie</b>		48.0																																																												
<b>Total</b>		194.0																																																												
1:	10.4x	←																																																												
2:	10.1	→																																																												
3:	10.1	→																																																												
4:	10.7x	↓																																																												
5:	10.0	←																																																												
<b>Serie</b>		50.0																																																												
<b>Total</b>		244.0																																																												
<b>5. Serie Ligg</b> 	<table border="1" style="width:100%; border-collapse: collapse;"> <tr><td>1:</td><td>10.2</td><td>↘</td></tr> <tr><td>2:</td><td>9.8</td><td>↗</td></tr> <tr><td>3:</td><td>10.0</td><td>←</td></tr> <tr><td>4:</td><td>10.2</td><td>↘</td></tr> <tr><td>5:</td><td>9.7</td><td>←</td></tr> <tr><td colspan="2"><b>Serie</b></td><td>48.0</td></tr> <tr><td colspan="2"><b>Total</b></td><td>292.0</td></tr> </table>	1:	10.2	↘	2:	9.8	↗	3:	10.0	←	4:	10.2	↘	5:	9.7	←	<b>Serie</b>		48.0	<b>Total</b>		292.0																																								
1:	10.2	↘																																																												
2:	9.8	↗																																																												
3:	10.0	←																																																												
4:	10.2	↘																																																												
5:	9.7	←																																																												
<b>Serie</b>		48.0																																																												
<b>Total</b>		292.0																																																												

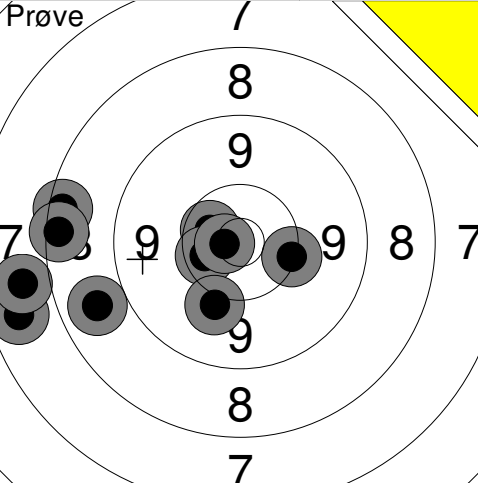
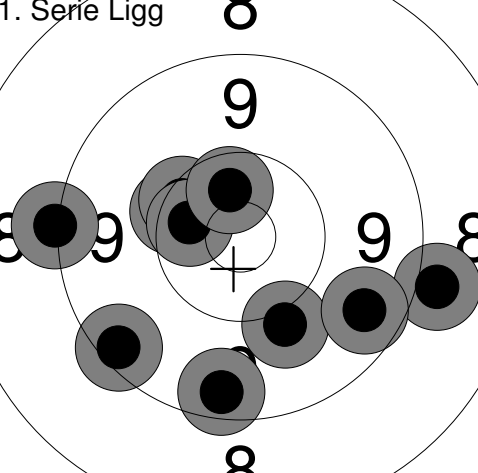
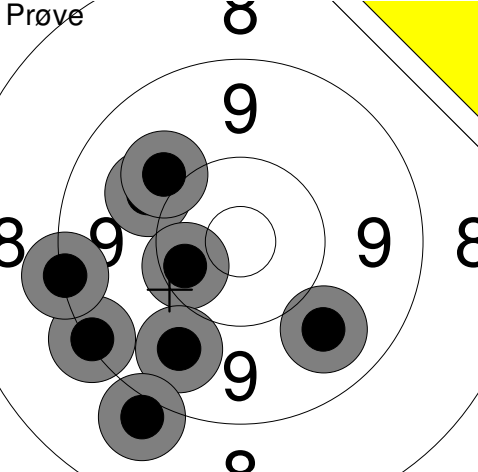
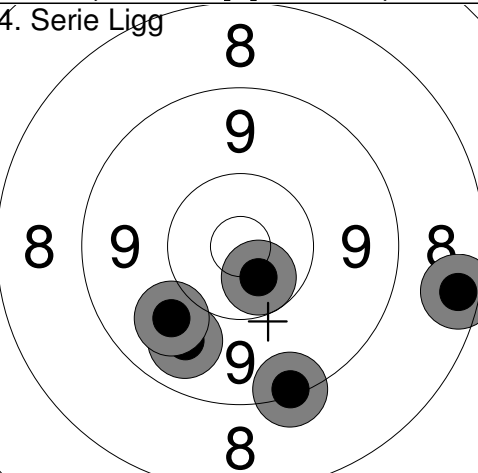
Hold	Skive	Leif Glud Laursen	
550	18		
50 meter afsnit 2		Karup Skytteforening af 1889	
		LIG	
Landsstævne 2017		Aalborg Skyttekreds	
Prøve		1: 7.6 ← 2: 7.8 ← 3: 10.5x ↗ 4: 10.4x ← 5: 10.7x ← 6: 10.0 ↓ 7: 8.7 ← 8: 8.4 ↗ 9: 8.4 ← 10: 10.2 ↘	Prøve
			11: 9.8 ↗ 12: 10.5x ↓
		Serie 88.0	Serie 19.0
		Total 0.0	Total 0.0
1. Serie Ligg		1: 9.0 → 2: 10.3 ↗ 3: 10.0 ↓ 4: 10.3 ↗ 5: 9.2 ← 6: 9.4 ↓ 7: 10.5x ↗ 8: 9.6 ↘ 9: 10.5x ↗ 10: 9.4 ↓	2. Serie Ligg
		Serie 95.0	Serie 48.0
		Total 95.0	Total 143.0
Prøve		1: 9.2 ← 2: 10.0 ↗ 3: 9.2 ← 4: 10.4 ← 5: 9.8 ↘ 6: 10.0 ↗ 7: 9.8 ↓ 8: 9.0 ↓	3. Serie Ligg
		Serie 75.0	Serie 48.0
		Total 143.0	Total 191.0
4. Serie Ligg		1: 9.7 ↓ 2: 9.3 ↓ 3: 9.9 ↓ 4: 8.4 ↘ 5: 10.6x ↘	5. Serie Ligg
		Serie 45.0	Serie 48.0
		Total 236.0	Total 284.0

Hold	Skive	Mathias Søndergaard	
550	19	Viborg Skytteforening	LIG
50 meter afsnit 2		Landsstævne 2017	Aalborg Skyttekreds
Prøve		1: 10.4 ↑ 2: 9.2 ← 3: 10.7x ← 4: 10.8x ↗ 5: 10.1 ↗ 6: 10.2 ← 7: 10.5x ↓ 8: 10.0 ↗ 9: 10.2 ↗ 10: 10.4 ↑ Serie 99.0 Total 0.0	1. Serie Ligg
		1: 10.4 ↑ 2: 10.3 ← 3: 10.4x ↗ 4: 10.6x ↗ 5: 9.9 ← 6: 10.6x ↓ 7: 10.7x ↓ 8: 10.6x ← 9: 10.2 ↓ 10: 10.4 → Serie 99.0 Total 99.0	
2. Serie Ligg		1: 10.4 ← 2: 9.8 ↗ 3: 10.0 ↓ 4: 10.8x ← 5: 10.5x ↑	Prøve
		1: 9.9 → 2: 10.8x ← 3: 10.7x ↑ 4: 10.3 ↑ 5: 10.4 ↗ 6: 10.1 →	
		1: 10.1 ↗ 2: 10.3 ↗ 3: 10.4x → 4: 10.6x ↓ 5: 10.3 ←	3. Serie Ligg
		1: 10.0 ↑ 2: 10.3 ↑ 3: 10.5x ↗ 4: 10.1 ← 5: 10.6x ↑	4. Serie Ligg
		1: 10.6x ↓ 2: 10.8x ↗ 3: 10.4x → 4: 10.1 ← 5: 10.1 ←	5. Serie Ligg
		Serie 50.0 Total 198.0	Serie 50.0 Total 248.0
		Serie 50.0 Total 298.0	

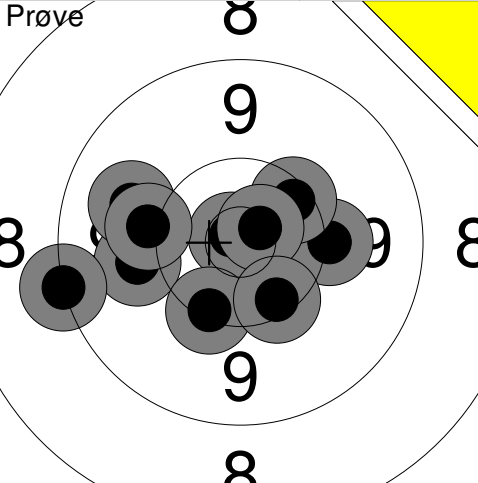
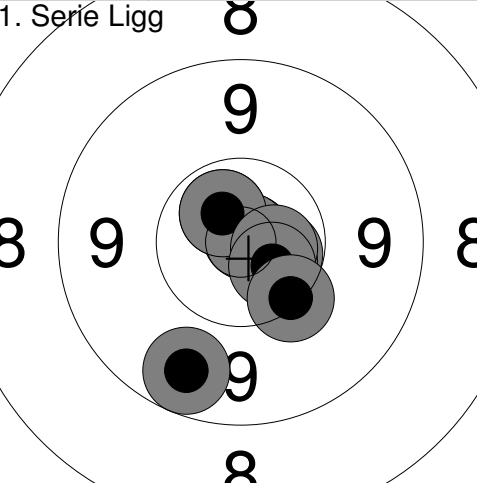
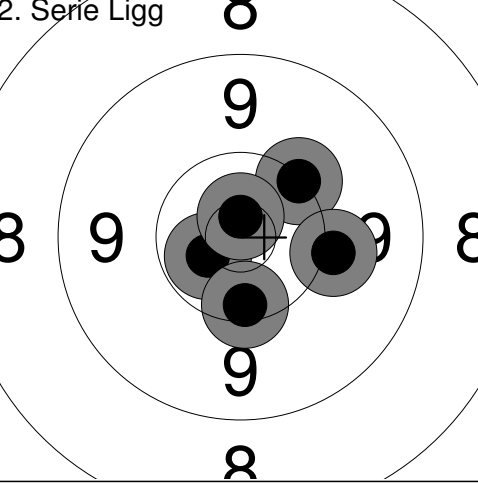
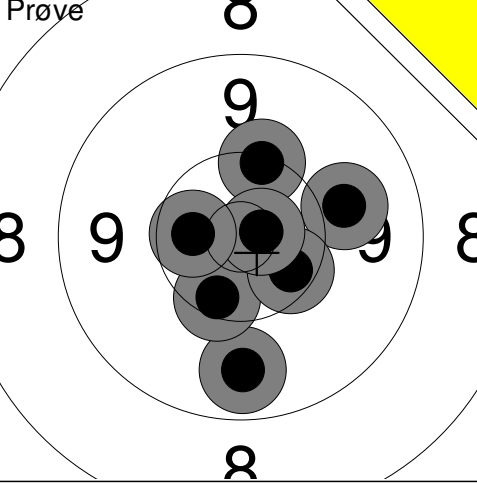
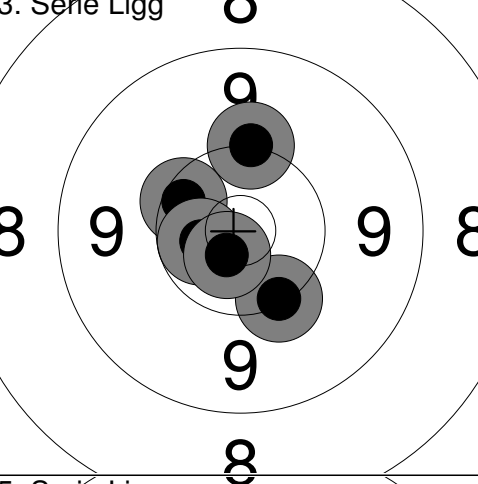
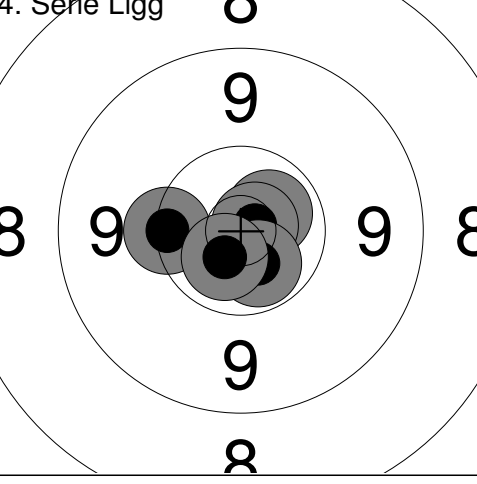
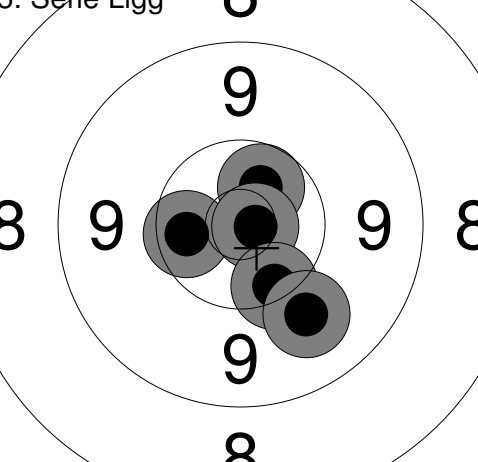
Hold	Skive	Hanne Kristensen			
551	13	Samsø Skytteforening			
50 meter afsnit 2		LIG			
Landsstævne 2017		Aalborg Skyttekreds			
Prøve		1: 10.8x ↖ 2: 10.0 ← 3: 9.2 ← 4: 10.2 ↓ 5: 9.9 ↗ 6: 10.1 ← 7: 10.1 → 8: 10.3 ↗ 9: 10.7x ↗ 10: 10.3 ↓ Serie 98.0 Total 0.0	1. Serie Ligg		1: 10.6x ↗ 2: 10.6x → 3: 10.6x ↘ 4: 10.9x ↗ 5: 10.9x ↗ 6: 9.6 ↓ 7: 10.6x ↗ 8: 10.6x → 9: 10.6x ↓ 10: 10.2 ↓ Serie 99.0 Total 99.0
2. Serie Ligg		1: 10.6x ← 2: 10.3 ↓ 3: 10.2 ↗ 4: 10.8x ↑ 5: 10.1 → Serie 50.0 Total 149.0	Prøve		1: 10.2 ↑ 2: 9.9 → 3: 9.7 ↓ 4: 10.3 ↓ 5: 10.4 ↓ 6: 10.8x → 7: 10.5x ← Serie 68.0 Total 149.0
3. Serie Ligg		1: 10.1 ↑ 2: 10.4 ↖ 3: 10.6x ← 4: 10.2 ↓ 5: 10.7x ↘ Serie 50.0 Total 199.0	4. Serie Ligg		1: 10.6x ↗ 2: 10.8x → 3: 10.3 ← 4: 10.6x ↓ 5: 10.7x ↘ Serie 50.0 Total 249.0
5. Serie Ligg		1: 10.4x ← 2: 10.6x ↗ 3: 10.8x → 4: 10.3 ↓ 5: 9.9 ↓ Serie 49.0 Total 298.0			

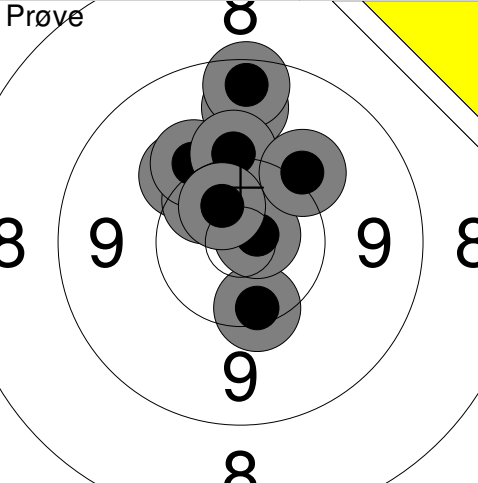
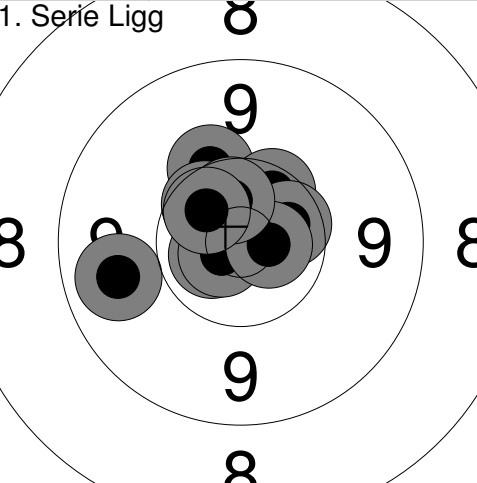
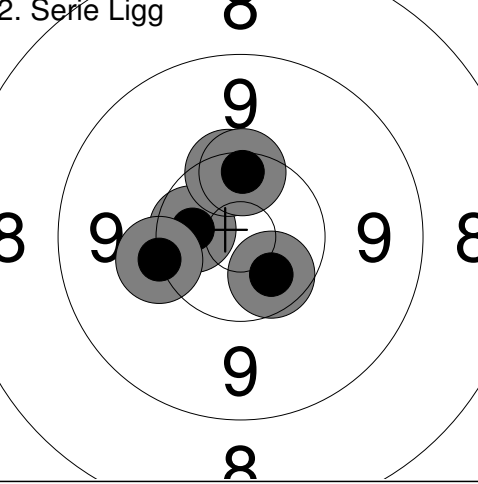
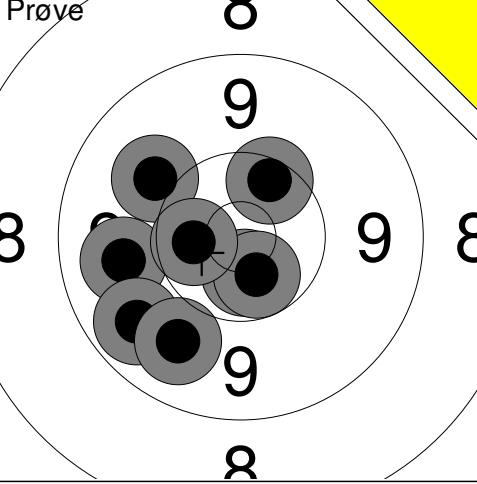
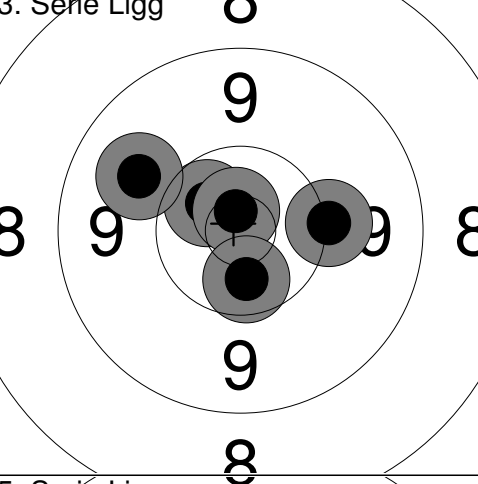
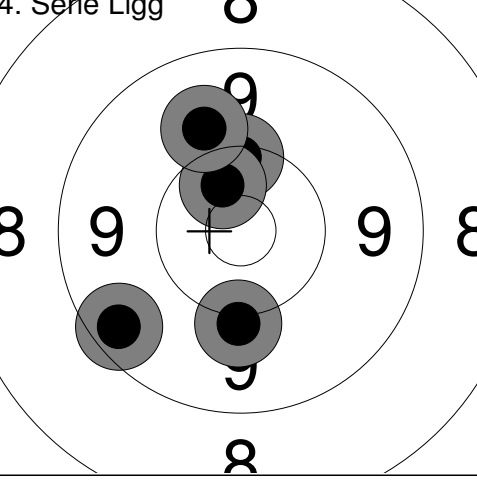
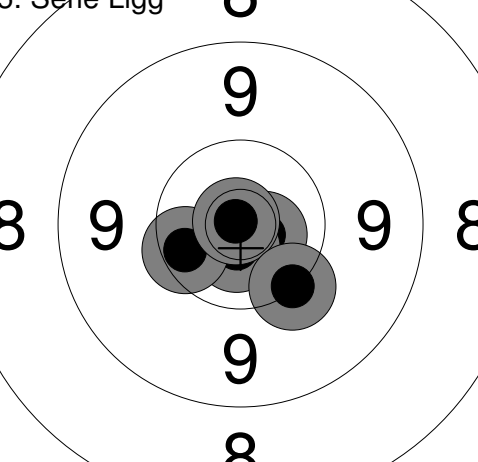

Hold	Skive	Alexander Petersen	
551	14	Samsø Skytteforening	
50 meter afsnit 2		LIG	
Landsstævne 2017		Aalborg Skyttekreds	
Prøve 	1: 10.3 ↓ 2: 10.1 ↗ 3: 9.7 ↗ 4: 9.4 ↗ 5: 10.4x ↗ 6: 10.8x → 7: 10.1 ↗ 8: 10.1 ↗ 9: 10.1 ↗ 10: 10.6x ↗ Serie 98.0 Total 0.0	1. Serie Ligg 	1: 10.2 ↗ 2: 10.4 ↗ 3: 10.5x ↗ 4: 10.5x → 5: 10.7x ← 6: 10.7x ← 7: 10.7x → 8: 9.7 ← 9: 10.5x ↗ 10: 10.5x ↗ Serie 99.0 Total 99.0
2. Serie Ligg 	1: 10.5x ← 2: 10.3 ↗ 3: 10.3 ↗ 4: 10.5x ↘ 5: 10.2 ← Serie 50.0 Total 149.0	Prøve 	1: 10.0 ↗ 2: 10.6x ↓ 3: 9.8 ← 4: 10.6x ↘ 5: 10.4 ↗ 6: 9.7 ← 7: 9.8 ↘ 8: 10.5x ← Serie 77.0 Total 149.0
3. Serie Ligg 	1: 10.5x ↗ 2: 10.8x ↗ 3: 10.1 → 4: 9.9 ↗ 5: 10.5x ↘ Serie 49.0 Total 198.0	4. Serie Ligg 	1: 10.3 ↗ 2: 9.5 ← 3: 10.5x ↗ 4: 9.9 ↗ 5: 10.1 ↘ Serie 48.0 Total 246.0
5. Serie Ligg 	1: 10.7x → 2: 10.7x ↓ 3: 10.4 ← 4: 10.9x ↗ 5: 10.2 ↘ Serie 50.0 Total 296.0		

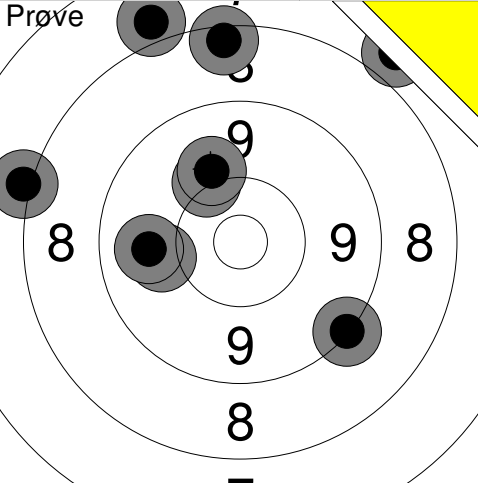
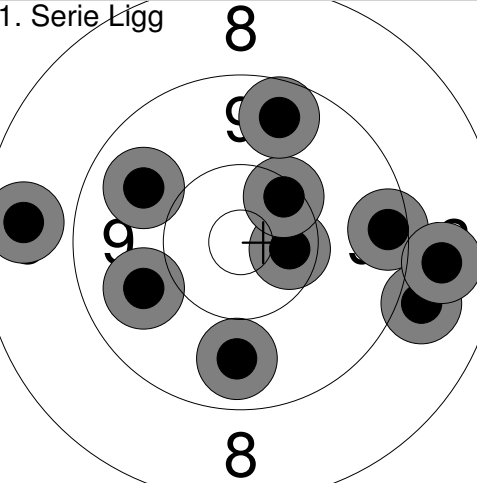
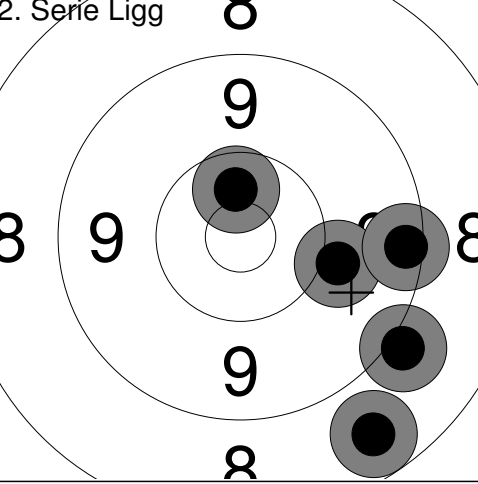
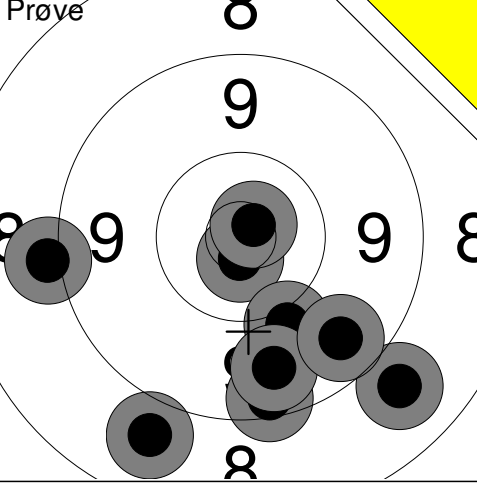
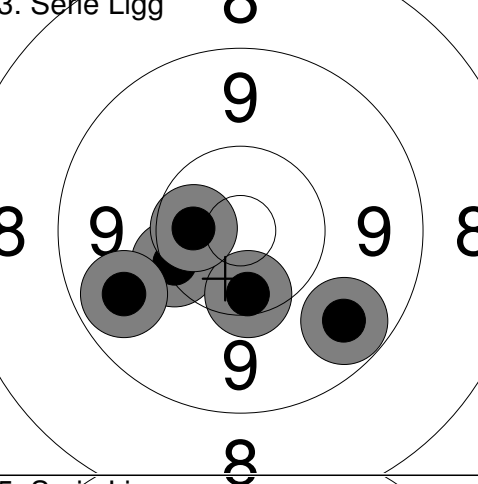
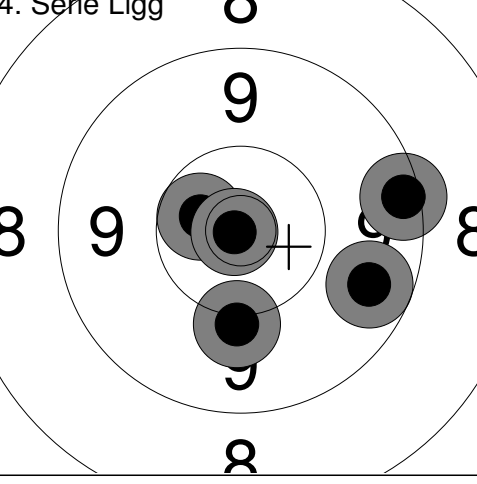
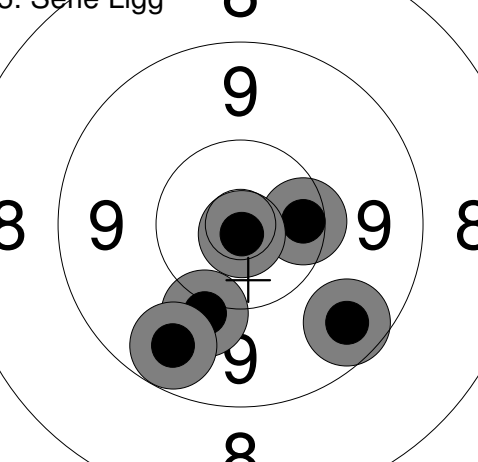
Hold	Skive	Sanne Kristensen	
551	15		
50 meter afsnit 2		Samsø Skytteforening	LIG
		Landsstævne 2017	Aalborg Skyttekreds
Prøve 	1: 7.8 ↗ 2: 8.4 ↑ 3: 7.9 ↗ 4: 10.1 ↗ 5: 8.1 ↑ 6: 10.0 ← 7: 10.0 ↗ 8: 9.2 ↓ 9: 9.8 ← Serie 78.0 Total 0.0	1. Serie Ligg 	1: 9.8 ← 2: 10.4x → 3: 10.3 ↗ 4: 8.6 ← 5: 8.9 → 6: 9.7 ↓ 7: 9.4 → 8: 8.8 → 9: 9.8 ↗ 10: 9.6 ↑ Serie 89.0 Total 89.0
2. Serie Ligg 	1: 9.0 ↓ 2: 8.6 ↓ 3: 10.0 → 4: 10.5x ↑ 5: 9.4 → Serie 46.0 Total 135.0	Prøve 	1: 8.8 ↓ 2: 9.1 ← 3: 10.7x ↓ 4: 10.0 ↓ 5: 9.4 ↓ 6: 9.7 ↓ 7: 8.8 ↓ 8: 9.6 ↓ 9: 10.8x ↗ Serie 82.0 Total 135.0
3. Serie Ligg 	1: 10.3 ← 2: 10.4 ↓ 3: 9.7 ← 4: 10.5x ← 5: 9.6 ↓ Serie 48.0 Total 183.0	4. Serie Ligg 	1: 10.1 ↓ 2: 10.5x ← 3: 9.6 → 4: 10.9x ← 5: 9.3 → Serie 48.0 Total 231.0
5. Serie Ligg 	1: 10.4 → 2: 9.6 ↓ 3: 10.1 ↓ 4: 10.9x ↓ 5: 9.6 ↓ Serie 48.0 Total 279.0		

Hold	Skive	Pia Kleis	
551	16	Samsø Skytteforening	
50 meter afsnit 2		LIG	
Landsstævne 2017		Aalborg Skyttekreds	
Prøve		1: 9.9 ↖ 2: 9.1 ↗ 3: 9.7 ↘ 4: 9.6 → 5: 10.8x ↗ 6: 10.1 ↘	1. Serie Ligg
		Serie 56.0 Total 0.0	 1: 10.4 → 2: 10.7x ↓ 3: 10.0 ↖ 4: 10.8x ↙ 5: 10.6x ↘ 6: 9.8 ↑ 7: 10.1 ↑ 8: 10.7x ↑ 9: 10.6x ↘ 10: 10.7x ↘ Serie 99.0 Total 99.0
2. Serie Ligg		1: 10.1 ↓ 2: 10.2 ↑ 3: 10.3 ↘ 4: 10.1 ↘ 5: 9.9 ↗	Prøve
		Serie 49.0 Total 148.0	 1: 9.9 ↗ 2: 10.1 ↗ 3: 10.4 ↑ 4: 10.5x ↓ 5: 10.7x → Serie 49.0 Total 148.0
3. Serie Ligg		1: 10.2 → 2: 10.2 → 3: 9.8 ↖ 4: 10.1 ↖ 5: 10.4x ←	4. Serie Ligg
		Serie 49.0 Total 197.0	 1: 10.0 ↘ 2: 10.2 ↘ 3: 10.1 ↗ 4: 10.7x ↗ 5: 9.5 ↑ Serie 49.0 Total 246.0
5. Serie Ligg		1: 10.6x ← 2: 9.8 ↗ 3: 10.2 ↑ 4: 10.4x → 5: 10.3 ↑	
		Serie 49.0 Total 295.0	

Hold	Skive	Ellen Holm	
551	18		
50 meter afsnit 2		Samsø Skytteforening	
		LIG	
		Landsstævne 2017	Aalborg Skyttekreds
Prøve		1: 10.0 → 2: 10.2 ↙ 3: 10.0 ↘ 4: 9.7 ↙ 5: 10.4 → 6: 9.6 ← 7: 10.3 → 8: 10.5x ↘ 9: 10.3 ↑	1. Serie Ligg
		Serie 88.0 Total 0.0	 1: 9.5 ↑ 2: 10.3 ↙ 3: 10.5x ↑ 4: 10.1 ↖ 5: 10.0 ↓ 6: 9.7 → 7: 9.6 → 8: 10.8x ← 9: 10.6x ← 10: 9.1 →
		Serie 88.0 Total 0.0	Serie 96.0 Total 96.0
2. Serie Ligg		1: 10.0 → 2: 10.7x ↘ 3: 9.7 → 4: 10.7x ↙ 5: 10.3 ↗	Prøve
		Serie 49.0 Total 145.0	 1: 10.0 ↗ 2: 10.0 ↑ 3: 10.5x ← 4: 10.2 ↖ 5: 9.7 ↗ 6: 10.0 ↑ 7: 10.2 ↗
		Serie 49.0 Total 145.0	Serie 69.0 Total 145.0
3. Serie Ligg		1: 10.8x ← 2: 9.7 → 3: 10.4x → 4: 9.8 → 5: 9.4 →	4. Serie Ligg
		Serie 47.0 Total 192.0	 1: 10.2 ↖ 2: 10.8x ↑ 3: 10.1 ↖ 4: 10.4 ↖ 5: 10.7x ↑
		Serie 47.0 Total 192.0	Serie 50.0 Total 242.0
5. Serie Ligg		1: 10.5x ↗ 2: 10.2 → 3: 10.5x ↘ 4: 10.3 ↘ 5: 10.3 ↗	
		Serie 50.0 Total 292.0	
		Serie 50.0 Total 292.0	

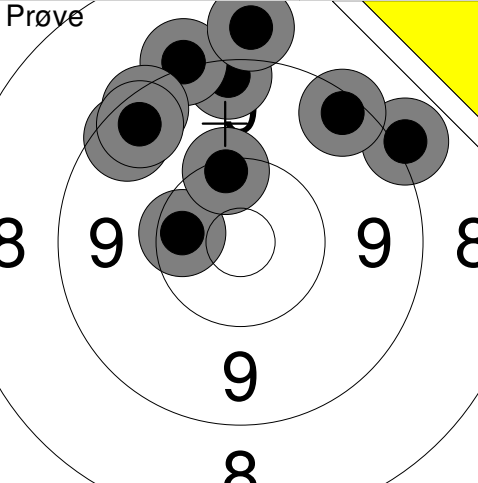
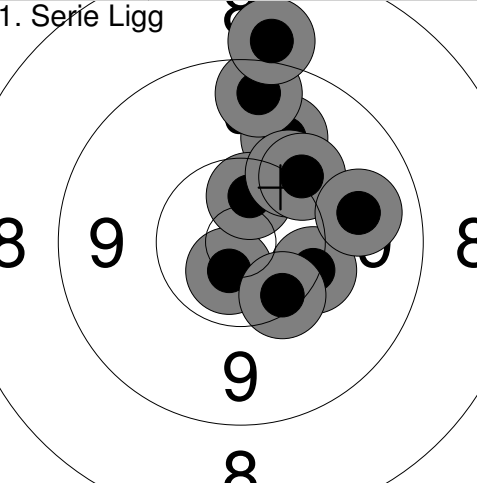
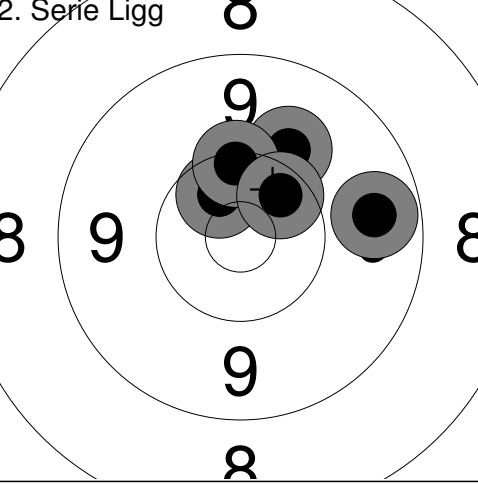
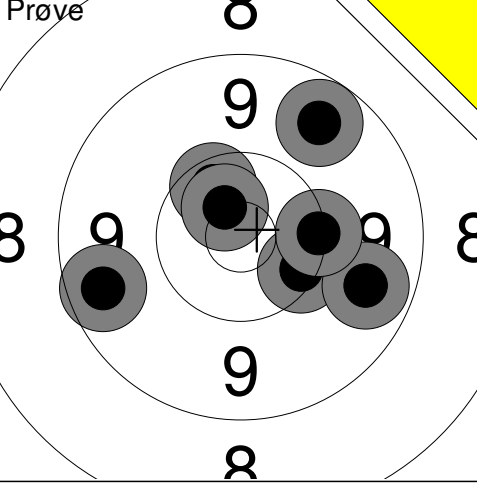
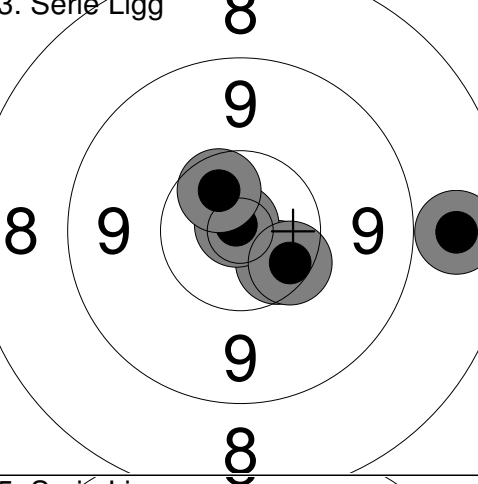
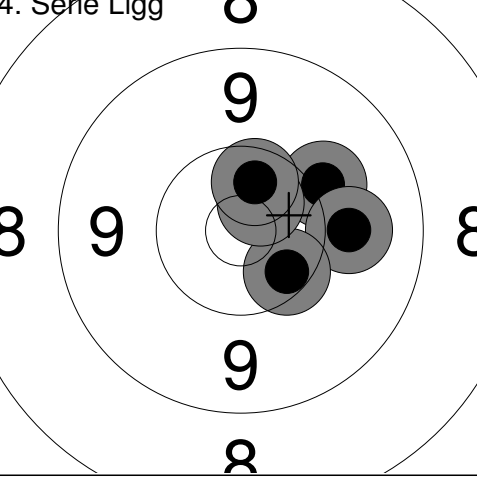
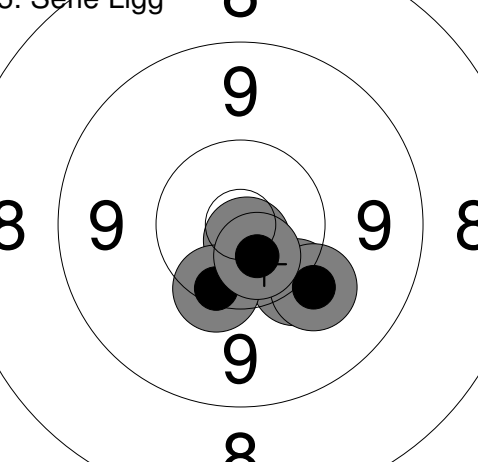
Hold	Skive	Jenny Bissø	
551	19	Samsø Skytteforening	
50 meter afsnit 2		LIG	
Landsstævne 2017		Aalborg Skyttekreds	
Prøve 	1: 10.4 ← 2: 9.3 ↑ 3: 9.1 ↑ 4: 10.3 ↑ 5: 8.8 ↑ 6: 9.1 → 7: 9.4 → 8: 9.5 ↑ 9: 9.5 ↑ 10: 9.4 ↑ Serie 91.0 Total 0.0	1. Serie Ligg 	1: 9.9 ↗ 2: 10.7x ↓ 3: 9.5 ↑ 4: 10.5x ↑ 5: 10.2 ↗ 6: 9.0 ↑ 7: 10.2 → 8: 10.1 ↗ 9: 9.8 → 10: 10.3 ↓ Serie 96.0 Total 96.0
2. Serie Ligg 	1: 10.0 ↗ 2: 10.5x ↗ 3: 10.3 ↑ 4: 9.7 → 5: 10.4 ↗ Serie 49.0 Total 145.0	Prøve 	1: 10.3 ↘ 2: 9.7 ↘ 3: 10.2 → 4: 10.4x ↗ 5: 9.6 ↗ 6: 9.5 ← 7: 10.6x ↗ Serie 67.0 Total 145.0
3. Serie Ligg 	1: 10.5x ↘ 2: 10.9x ↗ 3: 10.5x ↗ 4: 8.7 → 5: 10.4 ↘ Serie 48.0 Total 193.0	4. Serie Ligg 	1: 10.1 ↗ 2: 9.9 → 3: 10.4 ↘ 4: 10.6x ↗ 5: 10.5x ↑ Serie 49.0 Total 242.0
5. Serie Ligg 	1: 10.2 ↓ 2: 10.0 ↓ 3: 10.8x ↓ 4: 10.3 ↓ 5: 10.6x ↓ Serie 50.0 Total 292.0		

Hold	Skive	Knud Andersen	
551	20		
50 meter afsnit 2		Jelling fS Skydning	LIG
		Landsstævne 2017	Aalborg Skyttekreds
Prøve		1: 9.3 ↙ 2: 9.8 ↓ 3: 9.3 ← 4: 9.8 ↓ 5: 10.7x ↓ 6: 10.6x ↗ 7: 10.3 ↗ 8: 10.6x ← 9: 10.4x ↗ 10: 10.7x ↑	1. Serie Ligg
		Serie 96.0 Total 0.0	 1: 10.8x ↙ 2: 10.2 ↑ 3: 9.4 ↓ 4: 9.9 ↓ 5: 10.5x ← 6: 9.7 ↑ 7: 10.5x ↑ 8: 10.5x ↓ 9: 10.1 ↓ 10: 10.6x ↑
			Serie 97.0 Total 97.0
2. Serie Ligg		1: 10.6x ↓ 2: 10.1 ↓ 3: 10.2 ↓ 4: 10.1 ↗ 5: 10.2 ↗	Prøve
		Serie 50.0 Total 147.0	
			1: 10.3 ↑ 2: 10.3 ↑ 3: 9.5 ↖ 4: 10.6x ↓ 5: 10.1 ← 6: 10.3 ↓ 7: 10.7x ↓
			Serie 69.0 Total 147.0
3. Serie Ligg		1: 9.8 ↓ 2: 9.1 ← 3: 10.5x ↗ 4: 10.1 ↓ 5: 10.6x ↓	4. Serie Ligg
		Serie 48.0 Total 195.0	
			1: 10.1 ← 2: 10.6x ↓ 3: 10.4 ↗ 4: 10.6x ← 5: 10.4 ↓
			Serie 50.0 Total 245.0
5. Serie Ligg		1: 10.6x ↗ 2: 10.2 ↗ 3: 10.7x ← 4: 10.2 ↓ 5: 10.8x ↗	
		Serie 50.0 Total 295.0	

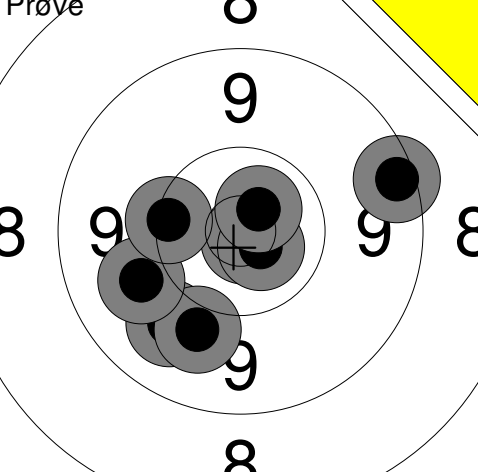
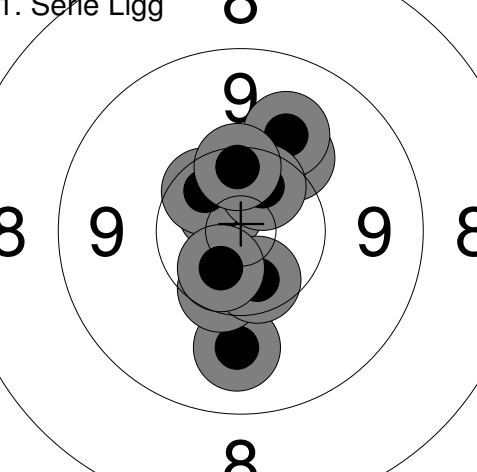
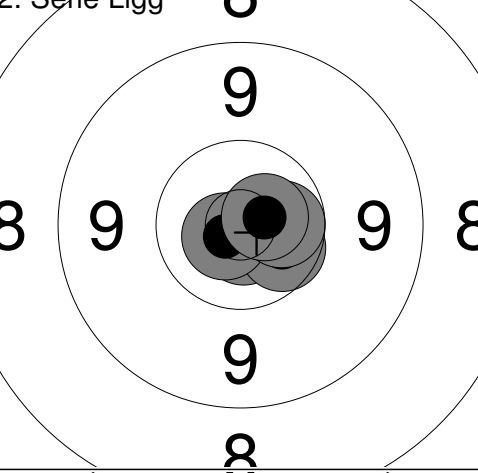
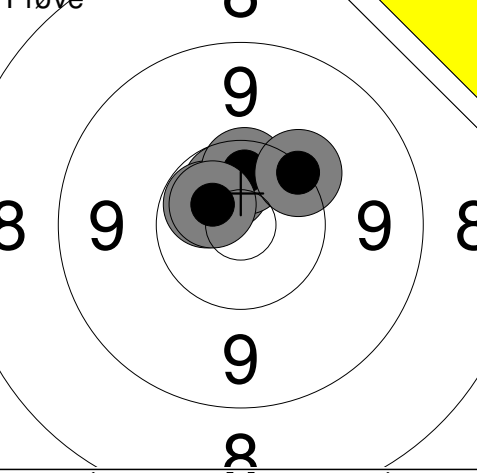
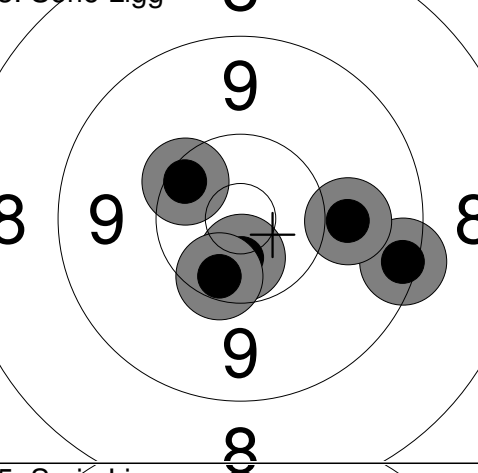
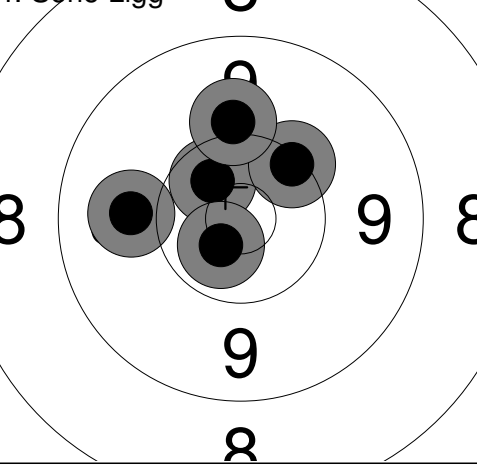
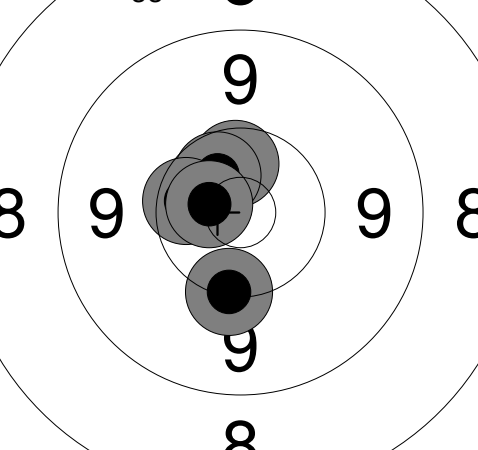
<p>Prøve</p> 	<p>1: 10.9x ↓</p> <p>2: 9.9 ↓</p> <p>3: 9.9 ↓</p> <p>4: 10.7x ↓</p> <p>5: 10.7x ↗</p> <p>6: 9.4 →</p> <p>7: 9.9 ←</p> <p>8: 10.3 ←</p> <hr/> <p>Serie 76.0</p> <hr/> <p>Total 0.0</p>	<p>1. Serie Ligg</p> 	<p>1: 9.9 ↓</p> <p>2: 10.4 ↓</p> <p>3: 10.7x ↗</p> <p>4: 10.1 ↗</p> <p>5: 10.5x ↓</p> <p>6: 10.4x ↗</p> <p>7: 10.0 ↗</p> <p>8: 10.5x ↗</p> <p>9: 10.3 ↑</p> <p>10: 10.6x ↓</p> <hr/> <p>Serie 99.0</p> <hr/> <p>Total 99.0</p>
<p>2. Serie Ligg</p> 	<p>1: 10.8x ↓</p> <p>2: 10.5x ↘</p> <p>3: 10.8x ↙</p> <p>4: 10.6x →</p> <p>5: 10.7x →</p> <hr/> <p>Serie 50.0</p> <hr/> <p>Total 149.0</p>	<p>Prøve</p> 	<p>1: 10.6x ↗</p> <p>2: 10.6x ↖</p> <p>3: 10.4x ↑</p> <p>4: 10.2 ↗</p> <p>5: 10.6x ↖</p> <hr/> <p>Serie 50.0</p> <hr/> <p>Total 149.0</p>
<p>3. Serie Ligg</p> 	<p>1: 10.6x ↓</p> <p>2: 10.4 ↓</p> <p>3: 10.3 ↗</p> <p>4: 9.3 →</p> <p>5: 9.9 →</p> <hr/> <p>Serie 48.0</p> <hr/> <p>Total 197.0</p>	<p>4. Serie Ligg</p> 	<p>1: 9.9 ←</p> <p>2: 10.5x ↗</p> <p>3: 10.6x ↘</p> <p>4: 10.3 ↗</p> <p>5: 10.0 ↑</p> <hr/> <p>Serie 49.0</p> <hr/> <p>Total 246.0</p>
<p>5. Serie Ligg</p> 	<p>1: 10.2 ↓</p> <p>2: 10.5x ↗</p> <p>3: 10.5x ↗</p> <p>4: 10.4x ↖</p> <p>5: 10.6x ↖</p> <hr/> <p>Serie 50.0</p> <hr/> <p>Total 296.0</p>		

Hold	Skive	Jytte Kristoffersen	
552	14		
50 meter afsnit 2		Gundsøllille SG&I	LIG
		Landsstævne 2017	Aalborg Skyttekreds
Prøve		1: 10.2 → 2: 9.5 → 3: 10.6x ↙ 4: 10.5x ↘ 5: 9.3 ↗ 6: 10.7x ↘	1. Serie Ligg
		Serie 58.0 Total 0.0	 1: 9.7 → 2: 9.7 ↘ 3: 10.2 → 4: 10.4 ↘ 5: 9.6 → 6: 10.9x ↘ 7: 9.8 ↑ 8: 9.1 → 9: 9.8 ↘ 10: 10.5x ↗ Serie 94.0 Total 94.0
2. Serie Ligg		1: 10.3 → 2: 10.2 → 3: 9.9 → 4: 10.7x ← 5: 10.0 ↗	Prøve
		Serie 49.0 Total 143.0	 1: 10.4 ↘ 2: 10.7x ↗ 3: 9.8 ↗ 4: 10.4 ↗ Serie 39.0 Total 143.0
3. Serie Ligg		1: 10.5x ↗ 2: 9.9 → 3: 10.1 ↗ 4: 9.3 ↑ 5: 10.5x ↘	4. Serie Ligg
		Serie 48.0 Total 191.0	 1: 9.4 → 2: 9.2 ↑ 3: 9.9 ↑ 4: 10.1 ↑ 5: 10.9x ↓ Serie 47.0 Total 238.0
5. Serie Ligg		1: 10.3 → 2: 10.1 → 3: 10.1 ↑ 4: 10.4 ↘ 5: 9.2 ↑	
		Serie 49.0 Total 287.0	

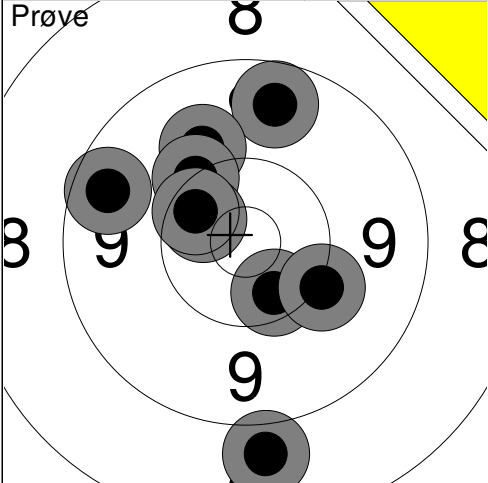
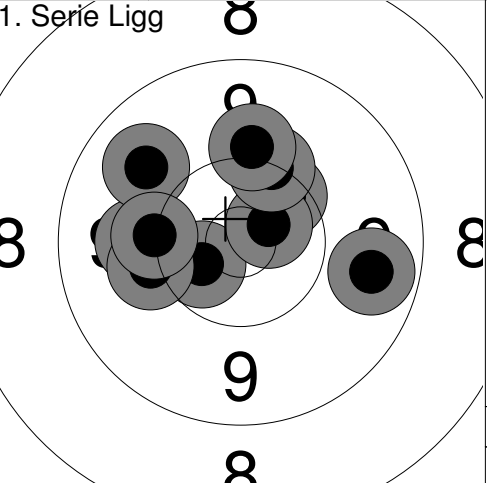
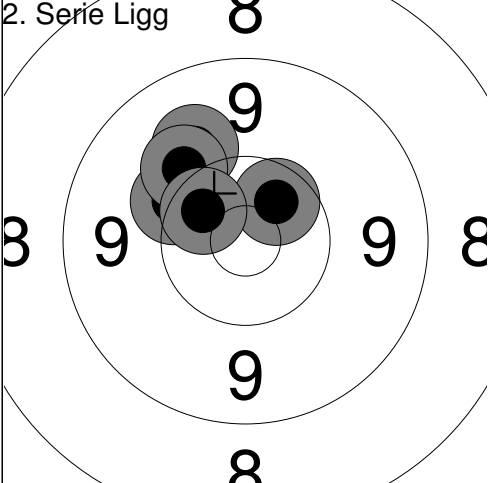
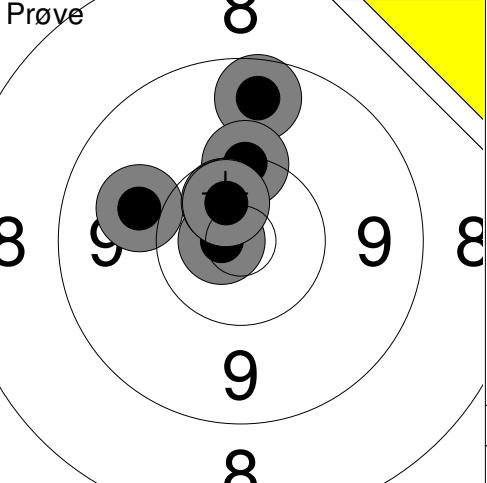
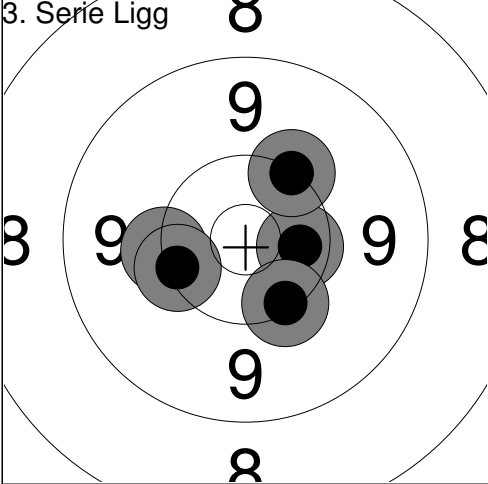
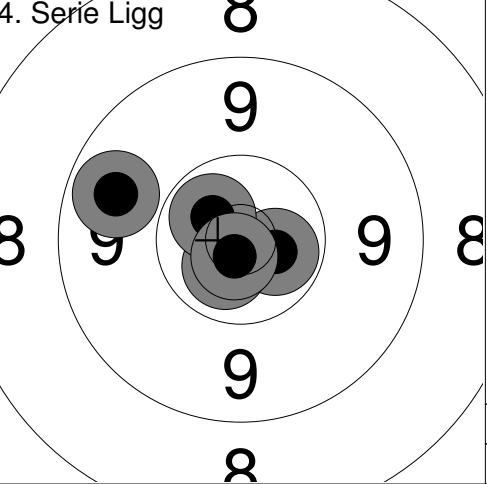
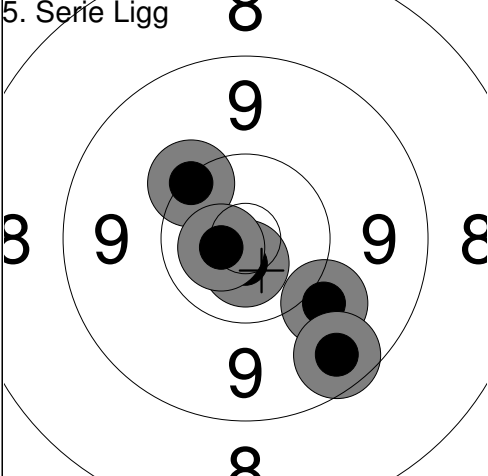

<b>Prøve</b> 	<b>1. Serie Ligg</b> 	<b>1. Serie Ligg</b> 
	1: 10.3 → 2: 10.4x → 3: 10.7x → 4: 10.1 ↗ 5: 10.6x ↗ 6: 9.6 ↗ 7: 10.1 ↗ 8: 9.1 ↗ 9: 9.8 ↘ 10: 10.6x ↗ Serie 97.0 Total 0.0	1: 10.2 ← 2: 10.2 ← 3: 10.0 ↑ 4: 9.7 ↑ 5: 9.7 ↘ 6: 10.2 ↗ 7: 10.5x ↗ 8: 9.2 ← 9: 10.3 ↘ 10: 10.9x ↑ Serie 97.0 Total 97.0
<b>2. Serie Ligg</b> 	<b>Prøve</b> 	<b>Prøve</b> 
	1: 10.2 ← 2: 10.1 ↑ 3: 10.3 ↘ 4: 10.6x → 5: 9.9 ↗ Serie 49.0 Total 146.0	1: 10.5x ↗ 2: 10.8x ↗ 3: 10.2 ↘ 4: 10.6x ↘ 5: 10.1 ↘ Serie 50.0 Total 146.0
<b>3. Serie Ligg</b> 	<b>4. Serie Ligg</b> 	<b>4. Serie Ligg</b> 
	1: 10.7x ↑ 2: 10.5x → 3: 10.4 ← 4: 10.2 → 5: 10.8x → Serie 50.0 Total 196.0	1: 9.7 ↘ 2: 10.4 ↑ 3: 10.3 ↗ 4: 9.9 ↗ 5: 10.6x ↘ Serie 48.0 Total 244.0
<b>5. Serie Ligg</b> 	<b>5. Serie Ligg</b> 	
	1: 9.7 ↘ 2: 10.8x ↗ 3: 10.6x ↗ 4: 10.6x ↘ 5: 10.2 ↗ Serie 49.0 Total 293.0	

Hold	Skive	Helle Jensen	
552	16		
50 meter afsnit 2		Gundsøllille SG&I	LIG
		Landsstævne 2017	Aalborg Skyttekreds
Prøve		1: 8.9 ↓ 2: 10.4 ↓ 3: 10.1 ↓ 4: 9.6 → 5: 10.0 → 6: 10.2 → 7: 9.5 ↑ 8: 10.5x ↑ 9: 10.4 ↑ Serie 86.0 Total 0.0	1. Serie Ligg  1: 9.7 → 2: 10.4 ↗ 3: 10.0 ← 4: 10.5x ↙ 5: 9.8 ↗ 6: 10.1 ← 7: 10.1 ← 8: 10.6x ↗ 9: 10.2 ↑ 10: 10.1 ↑ Serie 98.0 Total 98.0
2. Serie Ligg		1: 10.0 ↑ 2: 10.5x ↑ 3: 10.2 ↑ 4: 10.1 ↑ 5: 10.5x ↑ Serie 50.0 Total 148.0	Prøve  1: 9.6 ↑ 2: 10.2 ↑ 3: 9.9 ← 4: 10.8x ← 5: 10.6x ↑ 6: 10.6x ↑ Serie 58.0 Total 148.0
3. Serie Ligg		1: 10.4x → 2: 10.2 ↑ 3: 10.3 ↓ 4: 10.2 ← 5: 10.3 ← Serie 50.0 Total 198.0	4. Serie Ligg  1: 10.6x → 2: 9.7 ← 3: 10.7x ↓ 4: 10.6x ↗ 5: 10.8x ↓ Serie 49.0 Total 247.0
5. Serie Ligg		1: 10.0 ↓ 2: 10.7x ↓ 3: 10.2 ↑ 4: 10.7x ← 5: 9.5 ↓ Serie 49.0 Total 296.0	

Hold	Skive	Christian Hansen	
552	17		
50 meter afsnit 2		Sødinge Skytteforening	
		LIG	
		Landsstævne 2017	Aalborg Skyttekreds
Prøve		1: 9.9 ↓ 2: 10.6x ↓ 3: 10.2 → 4: 10.1 → 5: 10.8x ↗ 6: 10.1 ← 7: 10.3 ↘ 8: 9.4 ↗ 9: 10.2 →	1. Serie Ligg
		Serie 88.0 Total 0.0	 1: 10.0 → 2: 10.1 ↗ 3: 10.4x ↗ 4: 10.5x ← 5: 10.1 → 6: 9.9 ↗ 7: 9.9 ← 8: 9.5 ← 9: 10.0 → 10: 9.9 ← Serie 96.0 Total 96.0
2. Serie Ligg		1: 10.0 ↗ 2: 10.7x ↓ 3: 10.1 ↘ 4: 9.6 ↗ 5: 10.8x ←	Prøve
		Serie 49.0 Total 145.0	 1: 10.7x ↗ 2: 10.0 ↑ 3: 10.5x → 4: 10.3 → Serie 40.0 Total 145.0
3. Serie Ligg		1: 10.4x ← 2: 10.1 → 3: 9.6 ↘ 4: 10.7x ← 5: 9.2 →	4. Serie Ligg
		Serie 48.0 Total 193.0	 1: 10.5x → 2: 10.4x ↗ 3: 10.2 ↘ 4: 9.0 ↘ 5: 9.9 → Serie 48.0 Total 241.0
5. Serie Ligg		1: 9.7 → 2: 10.1 ↗ 3: 10.4 ↘ 4: 9.9 → 5: 10.3 ↘	
		Serie 48.0 Total 289.0	

Hold	Skive	Rasmus Larsen	
552	18		
50 meter afsnit 2		Sødinge Skytteforening	
		LIG	
Landsstævne 2017		Aalborg Skyttekreds	
Prøve		1: 10.0 ↙ 2: 9.9 ↓ 3: 10.7x ↙ 4: 10.6x ↙ 5: 10.4x ↘ 6: 10.3 ↗ 7: 10.5x ↗ 8: 10.1 ↓ 9: 10.8x ← 10: 10.6x →	Prøve
			11: 10.6x ←
		Serie 99.0	Serie 10.0
		Total 0.0	Total 0.0
1. Serie Ligg		1: 9.8 ← 2: 10.7x ↗ 3: 10.6x ↙ 4: 10.3 ↓ 5: 10.4 → 6: 10.5x ↗ 7: 10.7x ↗ 8: 10.1 ← 9: 10.5x ↘ 10: 10.4 →	2. Serie Ligg
			1: 10.5x ↖ 2: 10.4x ↓ 3: 10.6x ↗ 4: 10.7x ↗ 5: 10.0 ↗
		Serie 99.0	Serie 50.0
		Total 99.0	Total 149.0
Prøve		1: 10.6x ← 2: 10.6x → 3: 10.8x ↗ 4: 9.3 → 5: 10.4 ↑ 6: 10.7x ↙	3. Serie Ligg
			1: 10.3 ↓ 2: 10.4x ← 3: 10.0 ↓ 4: 9.6 → 5: 10.0 →
		Serie 59.0	Serie 49.0
		Total 149.0	Total 198.0
4. Serie Ligg		1: 10.5x ← 2: 10.4x ↗ 3: 9.7 → 4: 10.1 ↗ 5: 9.7 →	5. Serie Ligg
			1: 10.7x ↗ 2: 8.7 ↖ 3: 9.7 ↗ 4: 10.7x ↗ 5: 9.8 ↗
		Serie 48.0	Serie 46.0
		Total 246.0	Total 292.0

Hold	Skive	Christian Larsen	
552	19		
50 meter afsnit 2		Sødinge Skytteforening	
		LIG	
		Landsstævne 2017	
		Aalborg Skyttekreds	
Prøve		1: 9.8 ↘ 2: 9.0 → 3: 10.3 ↘ 4: 10.5x ↘ 5: 10.5x → 6: 10.1 ↘ 7: 9.5 → 8: 9.6 ↘ 9: 10.5x ↘ 10: 10.2 ↘	1. Serie Ligg
		Serie 96.0	1: 10.4 ← 2: 9.9 ↘ 3: 9.3 ↘ 4: 10.1 ↑ 5: 10.2 ↘ 6: 10.6x ← 7: 10.1 ↑ 8: 9.7 ← 9: 10.0 → 10: 9.7 ↘
		Total 0.0	Serie 96.0
			Total 96.0
2. Serie Ligg		1: 10.0 ↗ 2: 10.1 ↑ 3: 10.1 ↘ 4: 9.7 ↑ 5: 10.1 ↘	Prøve
		Serie 49.0	1: 7.7 ← 2: 8.3 → 3: 10.4 ↗ 4: 10.8x ↘ 5: 10.0 ←
		Total 145.0	Serie 45.0
			Total 145.0
3. Serie Ligg		1: 9.9 ↘ 2: 9.8 ← 3: 9.9 ↘ 4: 10.2 ↗ 5: 9.8 ↗	4. Serie Ligg
		Serie 46.0	1: 10.0 ↘ 2: 10.3 ↗ 3: 10.2 ↗ 4: 10.4 ↘ 5: 10.6x ←
		Total 191.0	Serie 50.0
			Total 241.0
5. Serie Ligg		1: 10.7x ↗ 2: 10.4 → 3: 10.0 → 4: 10.2 ↘ 5: 10.1 ↗	
		Serie 50.0	
		Total 291.0	

Hold	Skive	Andreas Hansen	
552	20		
50 meter afsnit 2		Sødinge Skytteforening	
		LIG	
		Landsstævne 2017	Aalborg Skyttekreds
Prøve		1: 10.7x ↗ 2: 9.9 ← 3: 10.0 → 4: 9.8 ↗ 5: 10.3 ↗ 6: 10.6x ↗ 7: 10.1 ↘	1. Serie Ligg
		1: 10.6x ↘ 2: 9.2 ↘ 3: 10.1 ↗ 4: 10.5x ↖ 5: 10.4 → 6: 10.3 ↑ 7: 10.8x ↘ 8: 10.5x → 9: 9.6 ↖ 10: 10.4 ↘	
		Serie 68.0	Serie 98.0
		Total 0.0	Total 98.0
2. Serie Ligg		1: 10.2 ↓ 2: 10.5x ↗ 3: 10.1 ↘ 4: 9.9 → 5: 10.2 ↑	Prøve
		1: 9.8 ↗ 2: 9.7 ↗ 3: 10.0 ↘ 4: 9.5 ↘ 5: 9.4 ↘ 6: 10.3 → 7: 10.8x →	
		Serie 49.0	Serie 66.0
		Total 147.0	Total 147.0
3. Serie Ligg		1: 10.7x ↘ 2: 10.1 → 3: 10.0 ↑ 4: 10.1 → 5: 10.2 ↘	4. Serie Ligg
		1: 10.6x ↘ 2: 9.8 ↗ 3: 10.1 ↑ 4: 10.5x ↘ 5: 9.9 ↗	
		Serie 50.0	Serie 48.0
		Total 197.0	Total 245.0
5. Serie Ligg		1: 9.7 ↘ 2: 9.8 ↑ 3: 10.7x ↗ 4: 10.5x ↘ 5: 10.5x ↗	
		Serie 48.0	
		Total 293.0	

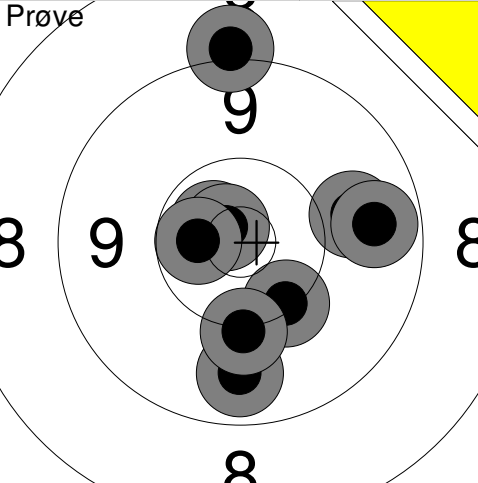
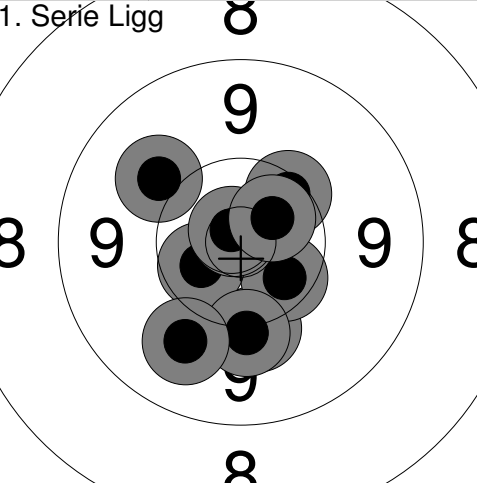
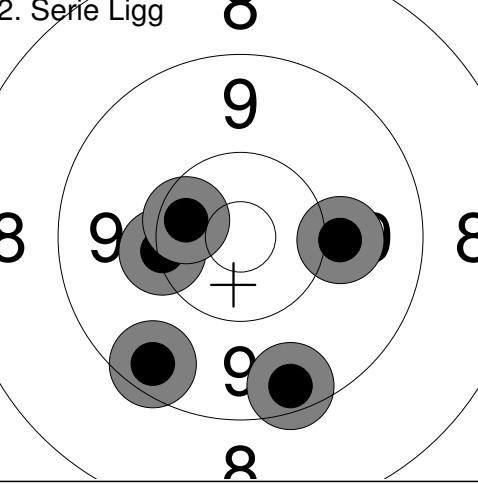
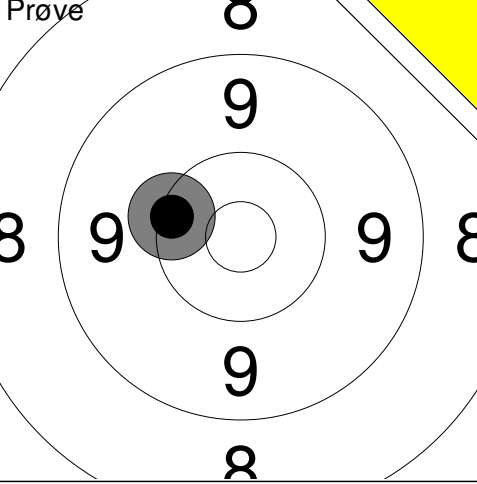
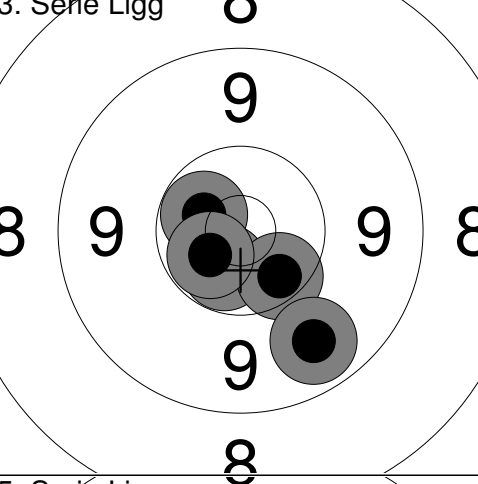
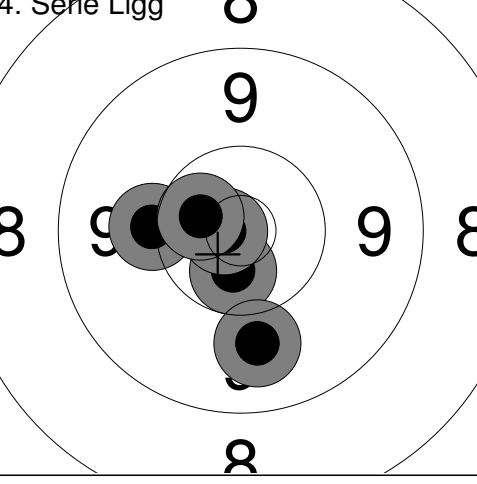
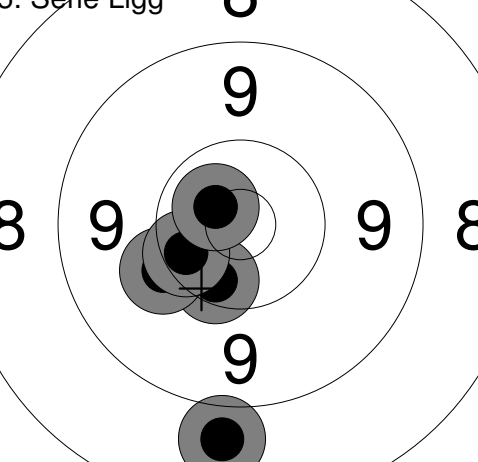
Hold	Skive	Morten de Place Bjørn	
553	13		
50 meter afsnit 2		Viborg Skytteforening	LIG
		Landsstævne 2017	Aalborg Skyttekreds
Prøve		1: 9.9 → 2: 9.7 ↓ 3: 10.7x ↗ 4: 10.8x ↗ 5: 9.1 ↑ 6: 10.2 ↓ 7: 9.7 → 8: 10.6x ← 9: 10.1 ↓	1. Serie Ligg
		Serie 86.0	
		Total 0.0	1: 10.1 ↓ 2: 10.4x ↘ 3: 10.5x ↖ 4: 10.1 ↓ 5: 9.9 ↓ 6: 10.3 ↗ 7: 10.8x ↗ 8: 10.8x ↗ 9: 10.0 ↗ 10: 10.6x ↗
2. Serie Ligg		1: 10.0 → 2: 9.4 ↓ 3: 10.2 ← 4: 10.4x ↗ 5: 9.5 ↓	1. Serie Ligg
		Serie 48.0	
		Total 147.0	1: 10.3 ←
3. Serie Ligg		1: 10.6x ↓ 2: 10.4 ↓ 3: 9.7 ↓ 4: 10.6x ↗ 5: 10.6x ↖	4. Serie Ligg
		Serie 49.0	
		Total 196.0	1: 10.6x ↓ 2: 10.8x ← 3: 10.1 ← 4: 10.6x ← 5: 9.9 ↓
5. Serie Ligg		1: 10.4 ↓ 2: 10.1 ↖ 3: 10.4 ↖ 4: 8.8 ↓ 5: 10.7x ↗	
		Serie 48.0	
		Total 293.0	

Hold	Skive	René Stricker Jensen	
553	14		
50 meter afsnit 2		Vodskov Skytteforening	LIG
		Landsstævne 2017	Aalborg Skyttekreds
Prøve		1: 10.9x ↘ 2: 10.6x → 3: 10.4 ↗ 4: 9.7 ↗ 5: 10.3 ↘ 6: 10.0 ↗ 7: 10.5x ↖ 8: 9.8 ↗ 9: 10.5x ↗ 10: 10.6x ↖ Serie 98.0 Total 0.0	1. Serie Ligg  1: 10.7x ↗ 2: 10.5x ↖ 3: 10.0 ↖ 4: 10.5x → 5: 10.8x ↖ 6: 10.4 ↖ 7: 10.5x ↗ 8: 10.8x ↘ 9: 10.8x ↘ 10: 10.4 ↗ Serie 100.0 Total 100.0
2. Serie Ligg		1: 10.8x → 2: 10.7x ↗ 3: 10.4 ↖ 4: 9.3 ↗ 5: 10.4 ↗ Serie 49.0 Total 149.0	Prøve  1: 10.7x ↘ 2: 9.6 ↘ 3: 9.6 ↘ 4: 10.4 ↗ 5: 10.5x ↘ 6: 9.9 ↘ 7: 10.0 ↖ Serie 67.0 Total 149.0
3. Serie Ligg		1: 10.4x ↖ 2: 10.2 ↖ 3: 10.3 ↗ 4: 10.3 ↖ 5: 10.7x ↗ Serie 50.0 Total 199.0	4. Serie Ligg  1: 10.1 ↗ 2: 10.3 ↗ 3: 9.8 → 4: 10.4x ↘ 5: 10.0 ↗ Serie 49.0 Total 248.0
5. Serie Ligg		1: 9.6 ↘ 2: 9.7 ↘ 3: 10.3 ↗ 4: 10.1 ↗ 5: 10.3 → Serie 48.0 Total 296.0	



Hold	Skive	Allan Bruun	
553	15		
50 meter afsnit 2		Væggerløse Skytteforening	
		LIG	
Landsstævne 2017		Aalborg Skyttekreds	
Prøve		1: 10.9x ↖ 2: 9.9 → 3: 10.2 → 4: 9.1 ← 5: 9.5 ← 6: 10.0 ← 7: 9.3 → 8: 9.8 ↗ 9: 10.4x ↗	1. Serie Ligg  1: 10.3 ← 2: 10.4x → 3: 10.4x ← 4: 9.0 ↗ 5: 9.3 ← 6: 10.2 ↓ 7: 10.3 ← 8: 10.6x → 9: 10.0 ↗ 10: 8.8 ↑
		Serie 85.0	Serie 96.0
		Total 0.0	Total 96.0
2. Serie Ligg		1: 9.5 ← 2: 8.9 ↗ 3: 10.0 ↗ 4: 10.0 ↓ 5: 9.2 ↗	Prøve  1: 8.8 ↗ 2: 8.9 ↗ 3: 9.3 ↓ 4: 9.1 ↗ 5: 10.1 ↗ 6: 9.9 → 7: 9.3 ↗
		Serie 46.0	Serie 62.0
		Total 142.0	Total 142.0
3. Serie Ligg		1: 10.8x ↑ 2: 10.5x ← 3: 9.1 ↗ 4: 9.5 ↑ 5: 9.8 ↗	4. Serie Ligg  1: 9.9 ← 2: 8.3 ↗ 3: 9.7 ↗ 4: 10.5x ↓ 5: 9.7 ↗
		Serie 47.0	Serie 45.0
		Total 189.0	Total 234.0
5. Serie Ligg		1: 10.4 ↗ 2: 9.5 → 3: 10.4x ↗ 4: 10.1 ← 5: 9.4 ↖	
		Serie 48.0	
		Total 282.0	

<b>Prøve</b> 	1: 7.9 ↘ 2: 8.2 ↘ 3: 9.0 ↘ 4: 8.5 → 5: 8.1 → 6: 9.9 ↑ 7: 9.5 ↗ 8: 8.1 ↗ 9: 9.7 → 10: 9.6 ↓ Serie 84.0 Total 0.0	<b>Prøve</b> 	11: 7.7 ↘ 12: 9.1 → 13: 9.7 → Serie 25.0 Total 0.0
------------------	--	------------------	--

<b>1. Serie Ligg</b> 	1: 10.6x → 2: 9.6 → 3: 10.6x ← 4: 10.5x ↓ 5: 9.9 ↓ 6: 10.7x → 7: 10.2 ↑ 8: 9.9 ↓ 9: 10.4 ← 10: 8.7 ↓ Serie 95.0 Total 95.0	<b>2. Serie Ligg</b> 	1: 8.9 ↓ 2: 8.6 → 3: 10.8x ← 4: 9.6 ↑ 5: 9.4 ↘ Serie 44.0 Total 139.0
--------------------------	---	--------------------------	---

<b>Prøve</b> 	1: 10.3 ↓ 2: 9.6 ↗ 3: 10.1 ↘ Serie 29.0 Total 139.0	<b>3. Serie Ligg</b> 	1: 9.9 ← 2: 9.7 ↗ 3: 9.6 ↓ 4: 9.8 ↓ 5: 7.6 → Serie 43.0 Total 182.0
------------------	---	--------------------------	---

<b>4. Serie Ligg</b> 	1: 9.5 ← 2: 9.5 → 3: 10.4 → 4: 9.4 ↓ 5: 7.3 ↓ Serie 44.0 Total 226.0	<b>5. Serie Ligg</b> 	1: 8.1 ↘ 2: 6.4 ↓ 3: 7.8 ← 4: 10.6x ↓ 5: 10.2 ↘ Serie 41.0 Total 267.0
--------------------------	--	--------------------------	--

Hold	Skive	Karen Lolle	
553	17	Væggerløse Skytteforening	
50 meter afsnit 2		LIG	
Landsstævne 2017		Aalborg Skyttekreds	
Prøve		1: 10.5x ↗ 2: 10.5x ↗ 3: 9.9 ↗ 4: 9.6 ↘ 5: 10.2 ↗ 6: 10.4x ↘ 7: 10.4 ↗ 8: 9.1 ↗	1. Serie Ligg
		Serie 77.0 Total 0.0	 1: 9.6 ↖ 2: 10.0 ↖ 3: 10.3 ↗ 4: 10.8x ↗ 5: 10.3 ↘ 6: 9.7 ↘ 7: 10.7x ↗ 8: 10.1 ↘ 9: 9.1 ↘ 10: 9.7 ↖ Serie 96.0 Total 96.0
2. Serie Ligg		1: 10.3 ↗ 2: 10.2 ↗ 3: 9.4 ↘ 4: 9.6 ↘ 5: 9.5 ↘	Prøve
		Serie 47.0 Total 143.0	 1: 9.4 ↘ 2: 10.2 ↘ 3: 8.7 ↘ 4: 10.2 ↗ 5: 9.8 ↗ 6: 10.1 ↘ Serie 56.0 Total 143.0
3. Serie Ligg		1: 8.7 ↘ 2: 9.9 ↘ 3: 10.7x → 4: 10.0 → 5: 9.8 ←	4. Serie Ligg
		Serie 46.0 Total 189.0	 1: 10.6x ↗ 2: 10.1 ↘ 3: 9.5 ↗ 4: 9.1 ↖ 5: 9.6 ↗ Serie 47.0 Total 236.0
5. Serie Ligg		1: 10.2 ↗ 2: 10.3 ↖ 3: 10.5x ↘ 4: 10.4 ↘ 5: 9.6 ↗	
		Serie 49.0 Total 285.0	

Hold	Skive	Poul Erik Hansen	
553	18		
50 meter afsnit 2		Væggerløse Skytteforening	
		LIG	
Landsstævne 2017		Aalborg Skyttekreds	
<b>Prøve</b> 	1: 8.3 ↖ 2: 10.2 ↗ 3: 10.0 → 4: 9.5 ↗ 5: 10.4 ↗ 6: 9.8 → 7: 9.6 ← 8: 9.6 ↖	<b>1. Serie Ligg</b> 	1: 10.2 ↗ 2: 10.1 ↘ 3: 9.7 ↘ 4: 10.2 ↘ 5: 9.9 ↗ 6: 10.3 ↗ 7: 9.8 ↘ 8: 10.1 ↘ 9: 9.0 ↘ 10: 9.2 ↘
Serie 74.0		Serie 95.0	
Total 0.0		Total 95.0	
<b>2. Serie Ligg</b> 	1: 10.0 ← 2: 10.5x ↘ 3: 10.3 → 4: 10.3 ← 5: 10.6x ↗	<b>Prøve</b> 	1: 10.2 → 2: 9.7 → 3: 10.6x ↘
Serie 50.0		Serie 29.0	
Total 145.0		Total 145.0	
<b>3. Serie Ligg</b> 	1: 10.1 → 2: 10.6x ↗ 3: 10.0 → 4: 10.4x ↘ 5: 9.9 →	<b>4. Serie Ligg</b> 	1: 9.0 ↘ 2: 10.3 ↘ 3: 9.4 ↗ 4: 10.8x → 5: 10.4x ↗
Serie 49.0		Serie 48.0	
Total 194.0		Total 242.0	
<b>5. Serie Ligg</b> 	1: 10.1 ↗ 2: 9.8 ↘ 3: 9.8 → 4: 10.4 ↗ 5: 10.4 →		
Serie 48.0			
Total 290.0			

Hold	Skive	Preben Grubbe	
553	19	Væggerløse Skytteforening	
50 meter afsnit 2		LIG	
Landsstævne 2017		Aalborg Skyttekreds	
Prøve		1: 10.8x ↗ 2: 10.5x ↓ 3: 9.2 ↓ 4: 10.1 ↓ 5: 10.1 ↗	1. Serie Ligg
		1: 9.1 ↓ 2: 10.3 ← 3: 8.8 ↓ 4: 10.7x → 5: 10.0 ↓ 6: 8.8 ↓ 7: 10.2 ↓ 8: 9.6 ↗ 9: 10.3 ↓ 10: 9.4 ↓	
		Serie 49.0	Serie 93.0
		Total 0.0	Total 93.0
2. Serie Ligg		1: 9.9 ↓ 2: 10.2 ↓ 3: 10.4 ↗ 4: 10.4x ↗ 5: 10.5x ↗	Prøve
		1: 9.1 ↓ 2: 10.4 ↗ 3: 10.0 ↓ 4: 10.1 ← 5: 10.4x ↗	
		Serie 49.0	Serie 49.0
		Total 142.0	Total 142.0
3. Serie Ligg		1: 9.7 ↘ 2: 10.2 ↑ 3: 9.6 ↑ 4: 10.6x ↓ 5: 10.0 ↗	4. Serie Ligg
		1: 9.9 ↓ 2: 10.4x ↑ 3: 9.3 ↗ 4: 9.3 ← 5: 9.6 ↓	
		Serie 48.0	Serie 46.0
		Total 190.0	Total 236.0
5. Serie Ligg		1: 10.2 → 2: 10.1 ↗ 3: 9.3 → 4: 10.4 ← 5: 9.9 ↓	
		Serie 48.0	
		Total 284.0	

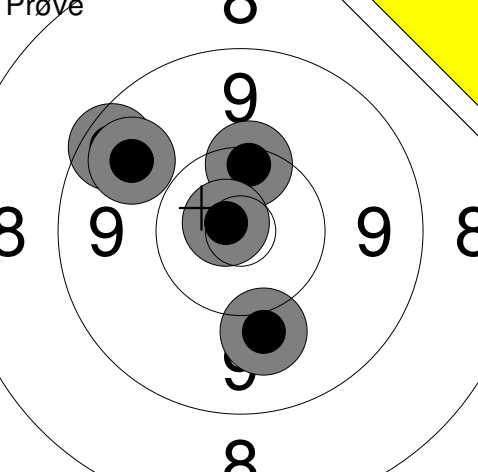
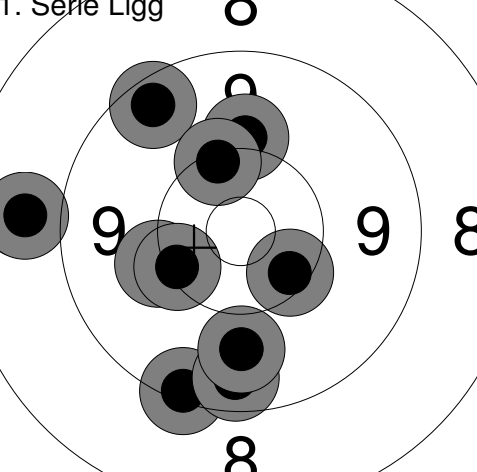
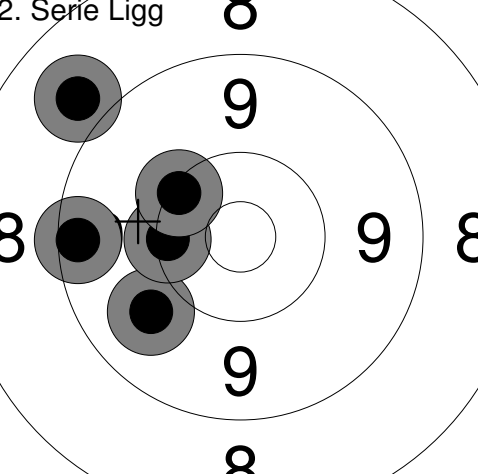
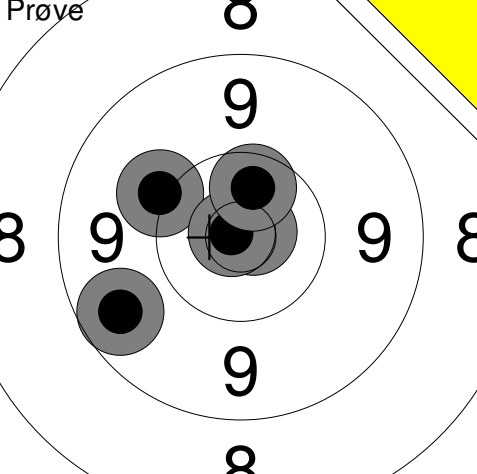
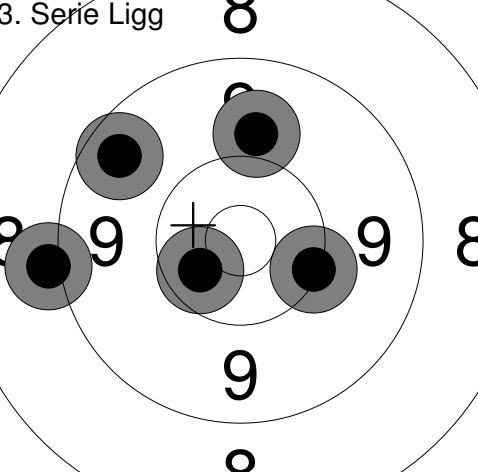
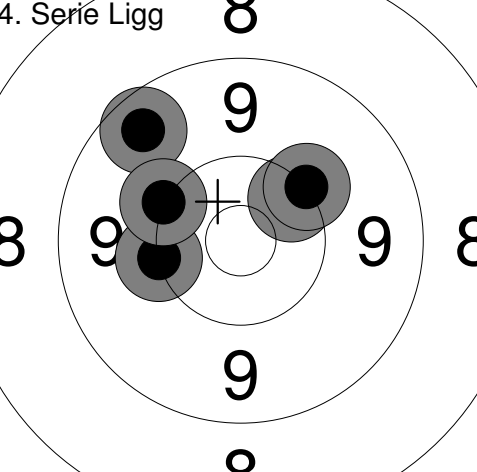
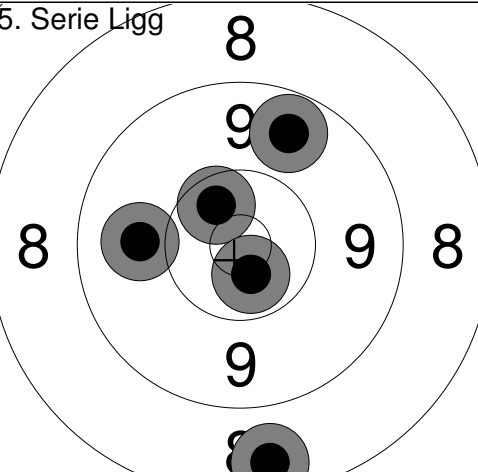
Prøve 	1: 9.5 ↗ 2: 10.0 ↓ 3: 10.3 ↑ 4: 9.7 ↗ 5: 10.8x ↗ <hr/> Serie 48.0 <hr/> Total 0.0	1. Serie Ligg 	1: 9.3 ↓ 2: 10.3 ↘ 3: 9.5 ↓ 4: 10.1 ← 5: 9.8 ↓ 6: 10.3 ← 7: 9.5 ↗ 8: 10.1 ↑ 9: 8.8 ← 10: 10.3 ↗ <hr/> Serie 94.0 <hr/> Total 94.0
2. Serie Ligg 	1: 9.4 ← 2: 8.9 ↗ 3: 9.9 ↘ 4: 10.3 ← 5: 10.2 ↗ <hr/> Serie 46.0 <hr/> Total 140.0	Prøve 	1: 10.8x → 2: 10.1 ↗ 3: 10.9x ← 4: 10.5x ↑ 5: 9.6 ↘ <hr/> Serie 49.0 <hr/> Total 140.0
3. Serie Ligg 	1: 10.2 → 2: 9.5 ↗ 3: 10.5x ↘ 4: 9.9 ↑ 5: 9.1 ← <hr/> Serie 47.0 <hr/> Total 187.0	4. Serie Ligg 	1: 10.3 ↗ 2: 10.2 ↗ 3: 10.2 ← 4: 9.5 ↗ 5: 10.1 ↗ <hr/> Serie 49.0 <hr/> Total 236.0
5. Serie Ligg 	1: 8.5 ↓ 2: 9.6 ↗ 3: 10.5x ↗ 4: 10.6x ↓ 5: 9.9 ← <hr/> Serie 46.0 <hr/> Total 282.0		

Hold	Skive	Anne B. Bertelsen	
554	13		
50 meter afsnit 2		Stege Ndr. Skytteforening	
		LIG	
		Landsstævne 2017	Aalborg Skyttekreds
Prøve		1: 9.4 2: 10.7x 3: 10.8x 4: 10.1 5: 9.8 6: 10.7x 7: 10.5x 8: 9.9 9: 9.9 10: 10.4x	Ligg
		Serie 96.0 Total 0.0	1: 9.6 2: 10.5x 3: 10.4 4: 10.5x 5: 9.9
			Serie 48.0 Total 48.0
Ligg		6: 10.4x 7: 10.6x 8: 10.6x 9: 10.6x 10: 10.3	Stå
		Serie 50.0 Total 98.0	1: 9.5 2: 10.7x 3: 10.0 4: 9.8 5: 10.7x
			Serie 48.0 Total 146.0
Knæ		1: 10.4 2: 9.4 3: 9.7 4: 10.5x 5: 9.8	Knæ
		Serie 47.0 Total 193.0	6: 10.0 7: 9.8 8: 10.5x 9: 10.2
			Serie 39.0 Total 232.0
Prøve		1: 10.1 2: 10.2 3: 10.1 4: 10.6x 5: 10.0	3S+3K+4L
		Serie 50.0 Total 232.0	1: 10.3 2: 9.6 3: 10.8x 4: 10.4 5: 10.7x
			Serie 49.0 Total 281.0
Stå		1: 10.1 2: 10.9x 3: 10.5x 4: 10.0 5: 9.4	
		Serie 49.0 Total 330.0	

Hold	Skive	Chris Olsen			
554	16				
50 meter afsnit 2		Stege Ndr. Skytteforening			
		BK			
		Landsstævne 2017	Aalborg Skyttekreds		
Prøve		1: 9.9 ↓ 2: 10.6x ← 3: 10.3 ← 4: 9.4 ↓ 5: 9.6 ↓ 6: 10.4 ← 7: 10.3 → 8: 10.1 ↓ 9: 10.3 ↓ 10: 10.4 → Serie 97.0 Total 0.0	Prøve		11: 10.5x ↓ 12: 10.0 → 13: 10.8x ↗ 14: 10.8x → Serie 40.0 Total 0.0
Ligg		1: 10.3 ↓ 2: 10.3 ↓ 3: 10.8x ↓ 4: 10.3 ↘ 5: 10.6x ↗ Serie 50.0 Total 50.0	Ligg		6: 10.2 ↗ 7: 10.4 ↓ 8: 10.2 ↖ 9: 10.3 ↓ 10: 10.8x ↓ Serie 50.0 Total 100.0
Stå		1: 10.8x ↑ 2: 10.3 ↗ 3: 9.8 → 4: 9.9 → 5: 10.6x ↓ Serie 48.0 Total 148.0	Knæ		1: 10.4 → 2: 10.8x ↑ 3: 10.5x ↓ 4: 10.6x → 5: 10.4 ↗ Serie 50.0 Total 198.0
Prøve		1: 10.7x ← 2: 10.5x → 3: 10.4x → 4: 10.3 ↓ 5: 10.6x ↓ Serie 50.0 Total 198.0	3S+3K+4L		1: 10.1 ← 2: 10.6x ↗ 3: 10.2 → 4: 10.6x → 5: 10.2 ↑ Serie 50.0 Total 248.0
Stå		1: 10.5x ↑ 2: 10.4 ↗ 3: 10.6x ↗ 4: 9.8 → 5: 10.7x → Serie 49.0 Total 297.0			



Hold	Skive	Helle Norup Bertelsen	
554	17		
50 meter afsnit 2		Viborg Skytteforening	
		LIG	
		Landsstævne 2017	
		Aalborg Skyttekreds	
Prøve		1: 10.3 ↑ 2: 10.8x ↓ 3: 10.7x ↗ 4: 10.3 ← 5: 10.6x ↓ 6: 10.6x ← 7: 10.2 ↑ 8: 10.6x ↓ 9: 10.4 →	Ligg
		Serie 90.0 Total 0.0	1: 9.8 ↓ 2: 10.5x ↓ 3: 10.3 ↓ 4: 10.1 ↑ 5: 10.7x ↓
			Serie 49.0 Total 49.0
Ligg		6: 10.6x ↓ 7: 9.9 ↑ 8: 10.9x ↗ 9: 10.1 ← 10: 10.6x ↓	Stå
		Serie 49.0 Total 98.0	1: 10.5x ↖ 2: 10.7x ← 3: 10.5x ↓ 4: 10.4 → 5: 10.0 →
			Serie 50.0 Total 148.0
Knæ		1: 10.3 ← 2: 10.2 → 3: 10.5x ↗ 4: 10.1 ← 5: 10.5x ↗	Knæ
		Serie 50.0 Total 198.0	6: 10.4x ↑ 7: 10.4 ←
			Serie 20.0 Total 218.0
Prøve		1: 10.7x ↓ 2: 10.5x ↑ 3: 10.3 → 4: 10.6x → 5: 9.8 →	3S+3K+4L
		Serie 49.0 Total 218.0	1: 10.3 ↖ 2: 10.1 ← 3: 10.4 ↑ 4: 10.3 ↗ 5: 10.2 ↗
			Serie 50.0 Total 268.0
Stå		1: 10.4 → 2: 10.1 ↓ 3: 10.2 ↓ 4: 10.5x ↗ 5: 10.6x ↓	
		Serie 50.0 Total 318.0	

Hold	Skive	Rikke Norup Bertelsen	
554	18		
50 meter afsnit 2		Viborg Skytteforening	BK
		Landsstævne 2017	Aalborg Skyttekreds
Prøve		1: 10.4x ↘ 2: 9.3 ← 3: 10.7x ↗ 4: 10.6x → 5: 10.0 ↘ 6: 10.3 ↘ 7: 10.1 ↘ 8: 10.5x →	Ligg
		Serie 79.0 Total 0.0	 1: 10.7x ↖ 2: 9.9 ↗ 3: 9.9 ↘ 4: 9.6 ← 5: 10.6x ↖
			Serie 47.0 Total 47.0
Ligg		6: 10.3 ← 7: 10.1 ↘ 8: 9.7 ↗ 9: 10.4 ↗ 10: 9.5 ↗	Stå
		Serie 48.0 Total 95.0	 1: 10.2 ↗ 2: 10.3 ← 3: 10.4x ↗ 4: 10.1 ↘ 5: 10.8x ↗
			Serie 50.0 Total 145.0
Knæ		1: 10.8x ↘ 2: 10.4x ← 3: 9.8 ← 4: 10.1 ↘ 5: 10.2 ←	Knæ
		Serie 49.0 Total 194.0	 6: 10.0 ↘
			Serie 10.0 Total 204.0
Prøve		1: 10.5x ↖ 2: 9.8 ↖ 3: 10.5x ↘ 4: 9.8 ↗ 5: 10.3 ↘	3S+3K+4L
		Serie 48.0 Total 204.0	 1: 10.7x ↖ 2: 10.0 ↘ 3: 9.4 ↖ 4: 10.4 ↗ 5: 10.0 ↖
			Serie 49.0 Total 253.0
Stå		1: 9.1 ↘ 2: 9.9 ↘ 3: 10.3 → 4: 10.2 ← 5: 10.8x ↗	
		Serie 48.0 Total 301.0	

Hold	Skive	Kristian Johansen		
554	19			
50 meter afsnit 2		Viborg Skytteforening	LIG	
		Landsstævne 2017	Aalborg Skyttekreds	
Prøve		1: 9.6 ← 2: 10.3 ↓ 3: 10.6x ← 4: 10.4x ← 5: 10.4 ← 6: 10.3 ↓ 7: 10.2 ← 8: 10.7x ↓ 9: 10.2 ↓ 10: 9.9 ↗	Ligg	 1: 10.1 ↓ 2: 10.1 ← 3: 9.4 ↓ 4: 10.2 ← 5: 10.3 ↓
		Serie 98.0	Serie 49.0	
		Total 0.0	Total 49.0	
Ligg		6: 10.4x ↗ 7: 10.1 ↓ 8: 10.6x ↓ 9: 10.9x ← 10: 9.9 ←	Stå	 1: 10.4x ↓ 2: 10.5x → 3: 10.1 ↓ 4: 9.3 ↓ 5: 10.4 ↑
		Serie 49.0	Serie 49.0	
		Total 98.0	Total 147.0	
Knæ		1: 10.1 ← 2: 9.8 ← 3: 10.2 ↗ 4: 10.2 ↗ 5: 10.5x ↗	Knæ	 6: 10.2 ↓
		Serie 49.0	Serie 10.0	
		Total 196.0	Total 206.0	
Prøve		1: 10.2 ↘ 2: 10.8x ↓ 3: 10.2 ↓ 4: 10.5x ↓ 5: 9.9 →	3S+3K+4L	 1: 10.6x ↗ 2: 10.0 ↓ 3: 10.5x ↓ 4: 10.7x ↗ 5: 10.6x ↗
		Serie 49.0	Serie 50.0	
		Total 206.0	Total 256.0	
Stå		1: 10.6x ↗ 2: 10.7x ↗ 3: 9.9 → 4: 10.3 ↓ 5: 9.9 ↓		
		Serie 48.0		
		Total 304.0		

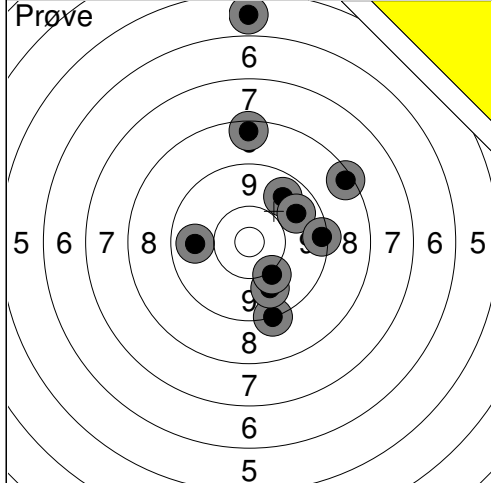

1:	5.7	↑
2:	8.4	↑
3:	8.3	→
4:	9.7	↗
5:	9.7	→
6:	9.2	↓
7:	9.3	→
8:	9.8	↓
9:	10.1	↓
10:	9.8	←

Serie	85.0
Total	0.0

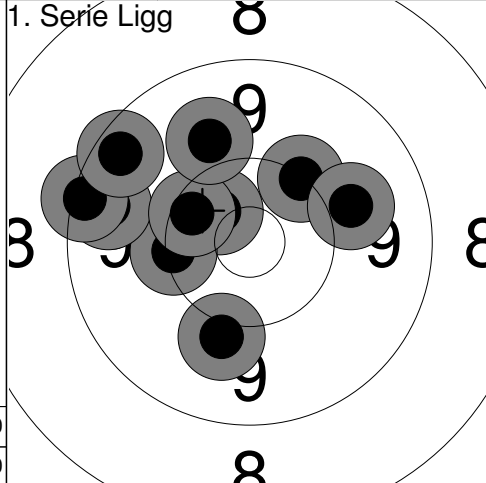

1:	10.5x	↗
2:	10.2	←
3:	10.0	↓
4:	9.6	←
5:	9.3	←
6:	9.4	↗
7:	10.3	↗
8:	9.9	↗
9:	10.2	↗
10:	9.9	↗

Serie	95.0
Total	95.0

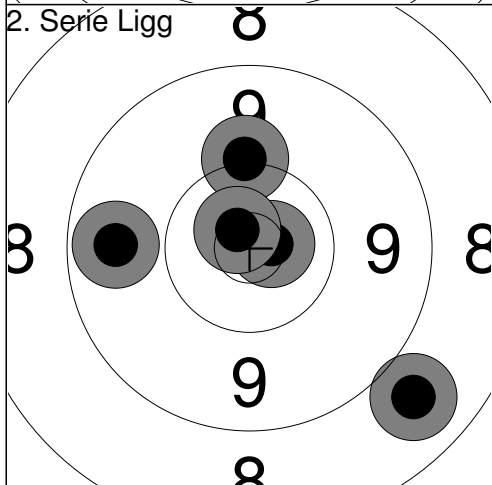

1:	9.7	←
2:	10.7x	→
3:	10.1	↑
4:	10.7x	↗
5:	8.8	↓

Serie	47.0
Total	142.0

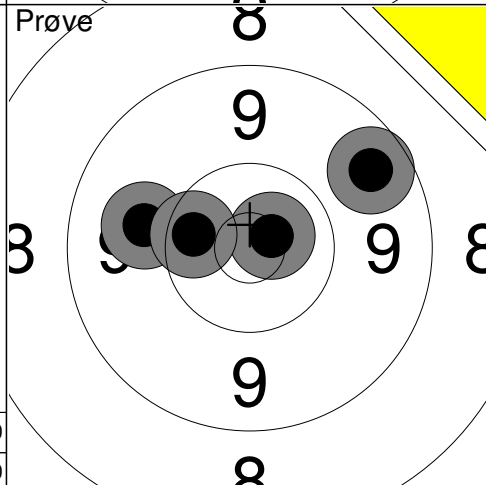

1:	10.7x	↗
2:	9.9	←
3:	10.4x	←
4:	9.6	↗

Serie	38.0
Total	142.0

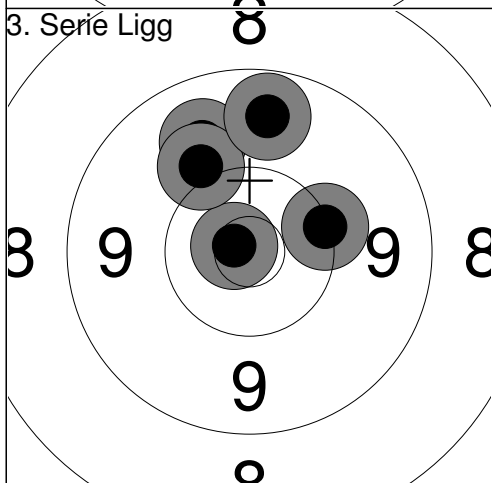

1:	10.2	→
2:	9.8	↗
3:	10.8x	↗
4:	10.0	↗
5:	9.6	↑

Serie	48.0
Total	190.0

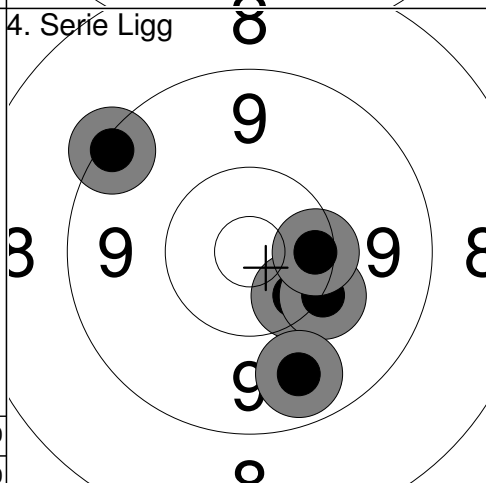

1:	10.4	↓
2:	10.1	↓
3:	9.3	↗
4:	9.7	↓
5:	10.3	→

Serie	48.0
Total	238.0

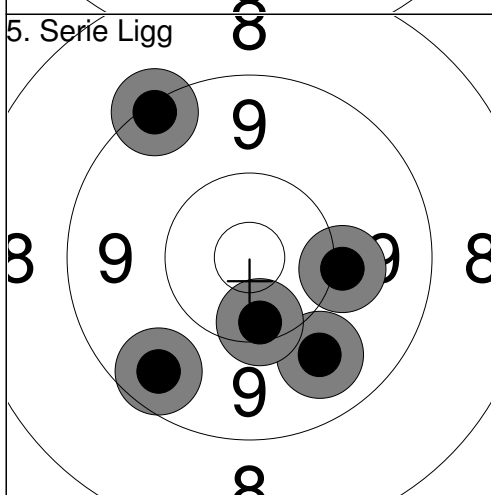

1:	10.1	→
2:	9.6	↓
3:	9.8	↓
4:	10.3	↓
5:	9.3	↗

Serie	47.0
Total	285.0

Hold	Skive	Anette Andersen	
555	14		
50 meter afsnit 2		Viborg Skytteforening	LIG
		Landsstævne 2017	Aalborg Skyttekreds
Prøve		1: 8.9 ↘ 2: 8.0 ↓ 3: 10.5x → 4: 10.5x ↗ 5: 10.1 ↗ 6: 9.5 → 7: 10.3 ← 8: 9.9 ↗ 9: 9.0 ↓ 10: 9.8 ←	Prøve 11: 10.2 ←
		Serie 92.0	Serie 10.0
		Total 0.0	Total 0.0
1. Serie Ligg		1: 10.2 ↓ 2: 10.4 ↓ 3: 10.4 ↗ 4: 9.9 ↓ 5: 10.3 ↓ 6: 10.9x ↑ 7: 10.2 ↓ 8: 10.4 ↗ 9: 9.7 ↓ 10: 10.3 ↗	1: 10.4 ↗ 2: 10.2 ↗ 3: 10.5x ↑ 4: 9.3 ↓
		Serie 98.0	Serie 39.0
		Total 98.0	Total 137.0
Prøve		1: 10.1 ↘ 2: 10.4 ↓ 3: 10.8x ↑ 4: 10.6x ← 5: 9.7 ↑ 6: 10.5x ↙ 7: 10.1 ↓	3. Serie Ligg
		Serie 69.0	Serie 48.0
		Total 137.0	Total 185.0
4. Serie Ligg		1: 10.4 ↓ 2: 9.6 ↓ 3: 8.6 ↓ 4: 9.7 ↑ 5: 10.5x ←	5. Serie Ligg
		Serie 46.0	Serie 48.0
		Total 231.0	Total 279.0
5. Serie Ligg		6: 10.4 ↓	
		Serie 10.0	
		Total 289.0	

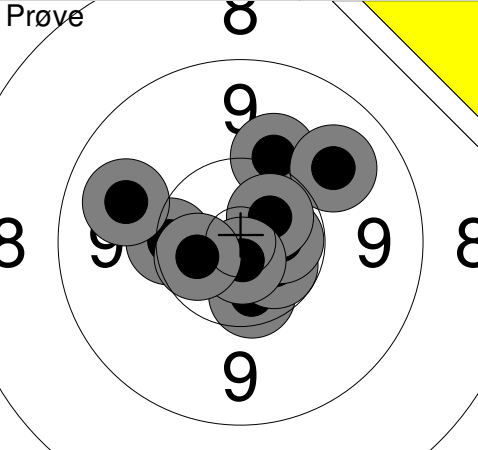
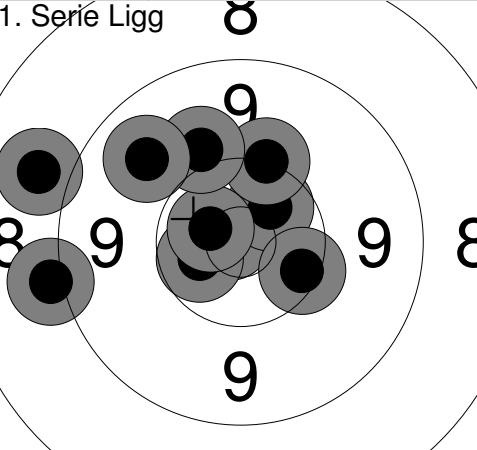
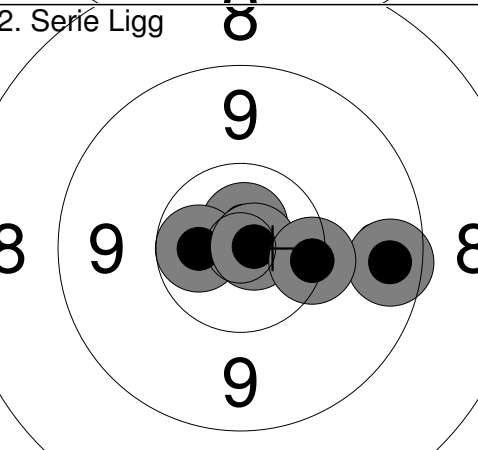
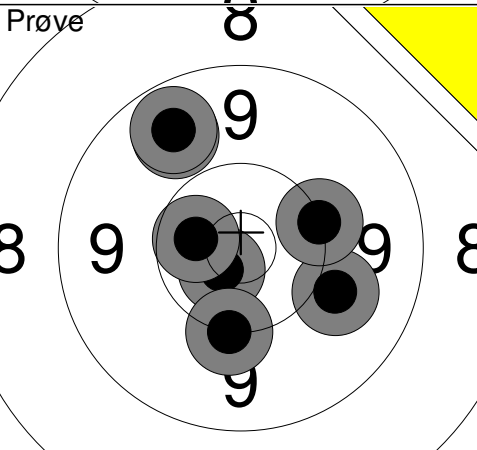
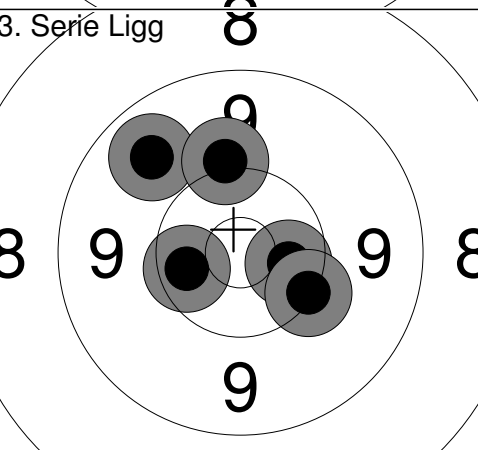
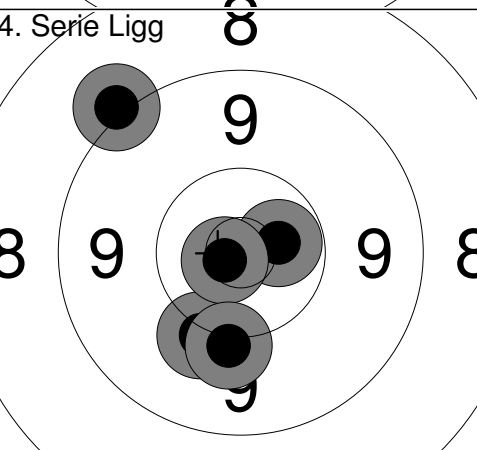
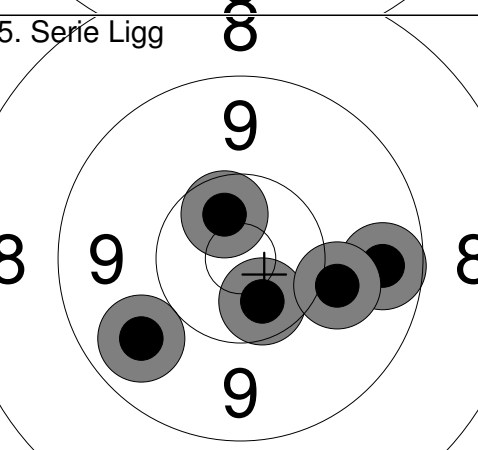
Hold	Skive	Trine Jakobsen	
555	15		
50 meter afsnit 2		Viborg Skytteforening	LIG
		Landsstævne 2017	Aalborg Skyttekreds
Prøve 	1: 10.1 ↗ 2: 9.8 → 3: 10.4x ↓ 4: 10.6x ↓ 5: 10.6x → 6: 10.6x ↗ 7: 10.8x ↓ 8: 10.3 ← 9: 10.5x ← 10: 9.8 ←	1. Serie Ligg 	1: 10.8x ↖ 2: 10.5x ↗ 3: 10.2 ↑ 4: 8.9 ↖ 5: 10.5x ↖ 6: 10.6x ↖ 7: 10.0 ↑ 8: 9.8 ↗ 9: 9.1 ← 10: 10.3 ↘
	Serie 98.0		Serie 96.0
	Total 0.0		Total 96.0
2. Serie Ligg 	1: 10.7x ↑ 2: 9.5 → 3: 10.6x ← 4: 10.8x → 5: 10.3 →	Prøve 	1: 9.7 ↗ 2: 9.7 ↗ 3: 10.7x ↘ 4: 10.0 ↘ 5: 10.2 ↓ 6: 10.2 → 7: 10.5x ←
	Serie 49.0		Serie 68.0
	Total 145.0		Total 145.0
3. Serie Ligg 	1: 10.4x ← 2: 10.5x → 3: 9.7 ↗ 4: 10.1 ↑ 5: 10.2 ↘	4. Serie Ligg 	1: 10.1 ↘ 2: 10.6x → 3: 9.1 ↗ 4: 10.8x ← 5: 10.1 ↓
	Serie 49.0		Serie 49.0
	Total 194.0		Total 243.0
5. Serie Ligg 	1: 10.5x ↓ 2: 9.7 ↖ 3: 10.5x ↗ 4: 9.6 → 5: 10.0 →		
	Serie 48.0		
	Total 291.0		

Hold	Skive	Knud Erik Holm			
555	16	Viborg Skytteforening	LIG		
50 meter afsnit 2		Landsstævne 2017	Aalborg Skyttekreds		
Prøve		1: 10.0 ↗ 2: 10.7x ↘ 3: 10.0 ← 4: 9.6 ↘ 5: 10.3 ↘ 6: 10.5x ← 7: 10.3 ↘ 8: 10.5x ↘ 9: 10.5x ↘	1. Serie Ligg		
		Serie 89.0 Total 0.0		1: 10.8x ↘ 2: 10.6x → 3: 10.5x → 4: 10.7x ↑ 5: 10.2 ← 6: 10.2 ↗ 7: 10.1 ↑ 8: 10.4 ← 9: 10.4x ↑ 10: 10.2 ↗	Serie 100.0 Total 100.0
2. Serie Ligg		1: 10.7x ↑ 2: 10.5x → 3: 10.3 ← 4: 10.5x ↘ 5: 10.6x ↘	Prøve		
		Serie 50.0 Total 150.0		1: 9.5 ↗ 2: 10.4 ↗ 3: 10.4x ↘ 4: 10.4x ↗ 5: 10.9x ↘ 6: 10.1 ↗	Serie 59.0 Total 150.0
3. Serie Ligg		1: 10.2 ↘ 2: 10.4x → 3: 10.6x ← 4: 10.5x ↘ 5: 9.7 ↘	4. Serie Ligg		
		Serie 49.0 Total 199.0		1: 10.7x ↘ 2: 9.9 ↘ 3: 10.1 ← 4: 10.7x ↘ 5: 10.9x →	Serie 49.0 Total 248.0
5. Serie Ligg		1: 10.1 ↘ 2: 10.8x ↘ 3: 10.5x ↗ 4: 10.2 ↗ 5: 9.6 ↘			
		Serie 49.0 Total 297.0			

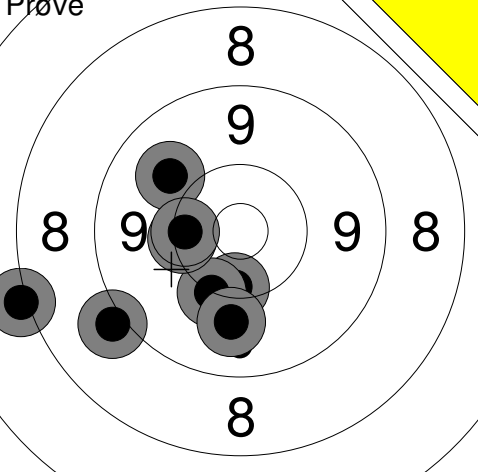
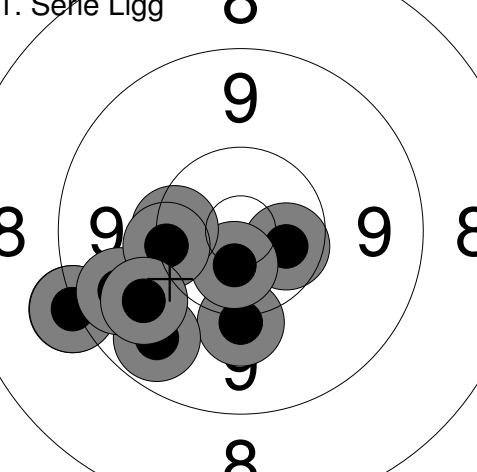
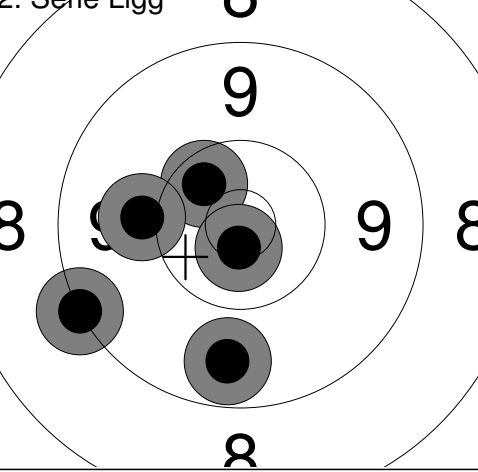
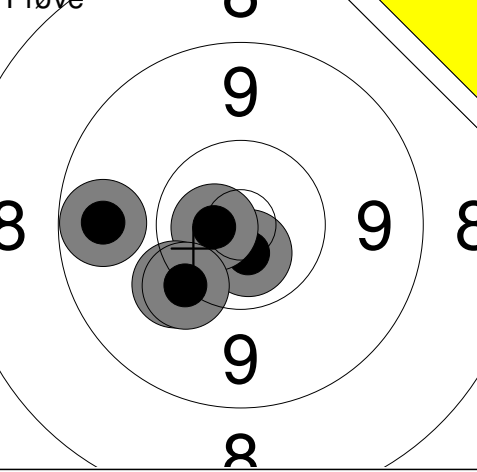
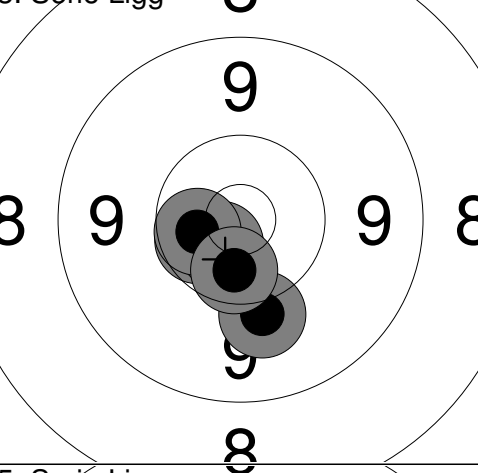
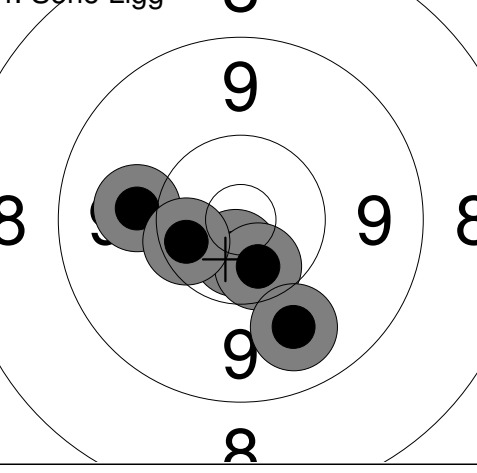
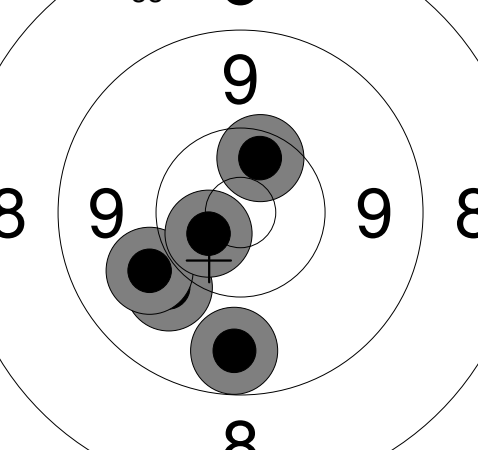
Hold	Skive	Allan Stryhn	
555	17	Tingsted Skytteforening	
50 meter afsnit 2		LIG	
Landsstævne 2017		Aalborg Skyttekreds	
<b>Prøve</b> 	1: 8.1 ← 2: 10.3 ↓ 3: 10.2 ↓ 4: 9.9 ↓ 5: 9.0 ← 6: 10.3 ← 7: 9.9 ↗ 8: 10.3 ← Serie 75.0 Total 0.0	<b>1. Serie Ligg</b> 	1: 10.1 ↓ 2: 10.5x → 3: 9.7 ↓ 4: 10.6x ↓ 5: 10.3 ← 6: 9.1 ← 7: 9.2 ← 8: 9.7 ← 9: 10.2 ← 10: 9.8 ↙ Serie 95.0 Total 95.0
<b>2. Serie Ligg</b> 	1: 10.4x ↗ 2: 10.0 ← 3: 9.2 ← 4: 9.6 ↓ 5: 10.7x ↓ Serie 48.0 Total 143.0	<b>Prøve</b> 	1: 10.7x ↓ 2: 9.6 ← 3: 10.7x ← 4: 10.1 ↙ 5: 10.2 ↙ Serie 49.0 Total 143.0
<b>3. Serie Ligg</b> 	1: 10.5x ← 2: 10.0 ↓ 3: 10.6x ↙ 4: 10.5x ← 5: 10.5x ↓ Serie 50.0 Total 193.0	<b>4. Serie Ligg</b> 	1: 10.6x ↓ 2: 10.0 ← 3: 10.5x ↓ 4: 9.8 ↙ 5: 10.4 ← Serie 49.0 Total 242.0
<b>5. Serie Ligg</b> 	1: 10.4 ↗ 2: 10.0 ↙ 3: 9.9 ↙ 4: 10.6x ↙ 5: 9.6 ↓ Serie 48.0 Total 290.0		

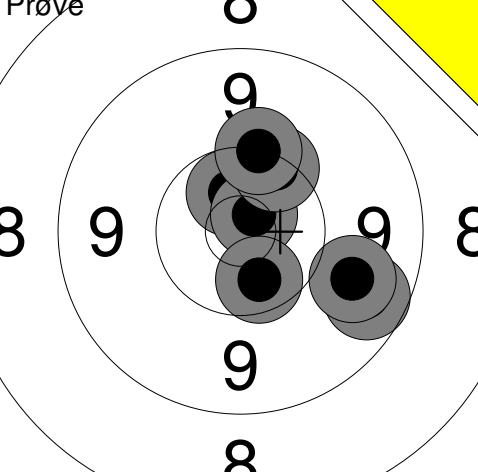
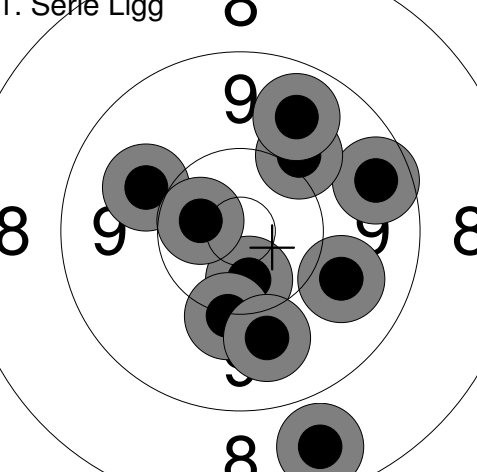
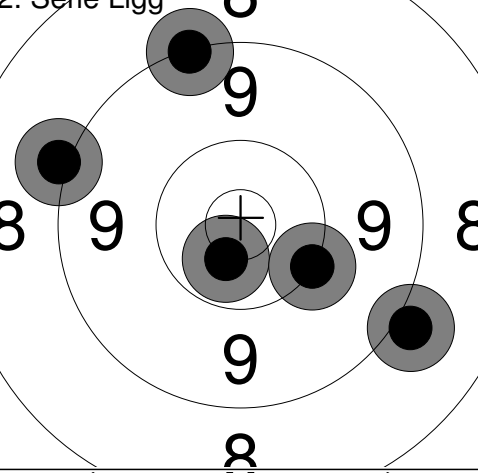
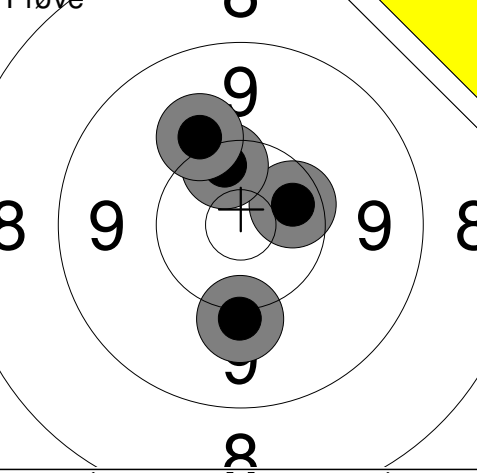
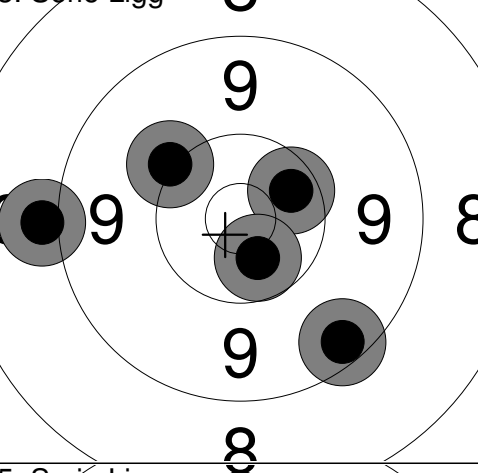
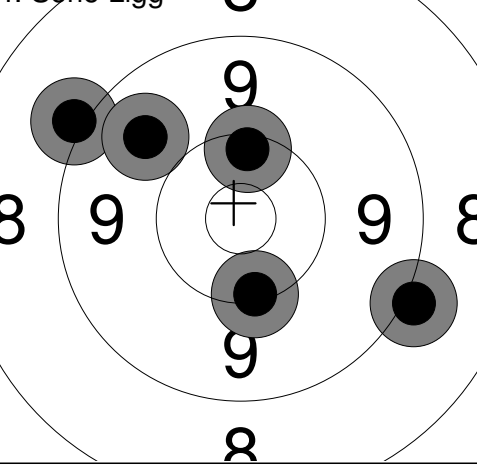
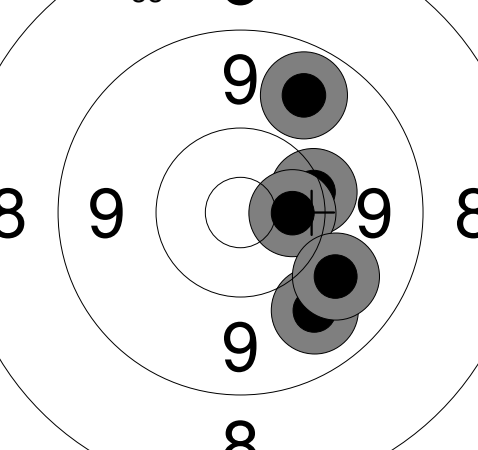

<p>Prøve</p> 	<p>1: 10.6x ↗</p> <p>2: 10.7x ↗</p> <p>3: 10.3 ↗</p> <p>4: 9.6 ↘</p> <p>5: 9.8 ↘</p> <p>6: 10.5x ↘</p> <p>7: 10.2 ↗</p>	<p>1. Serie Ligg</p> 	<p>1: 10.0 ↖</p> <p>2: 10.5x ↘</p> <p>3: 9.9 ↘</p> <p>4: 8.7 ↘</p> <p>5: 10.1 ↘</p> <p>6: 9.9 ↘</p> <p>7: 9.5 →</p> <p>8: 10.0 ↗</p> <p>9: 10.6x ←</p> <p>10: 9.7 ↗</p>
Serie 68.0	Total 0.0	Serie 94.0	Total 94.0
<p>2. Serie Ligg</p> 	<p>1: 9.1 ←</p> <p>2: 10.6x ↘</p> <p>3: 9.2 ↗</p> <p>4: 9.0 ↘</p> <p>5: 10.2 ↘</p>	<p>Prøve</p> 	<p>1: 10.1 ↘</p> <p>2: 10.4x →</p> <p>3: 10.4 ↗</p> <p>4: 10.0 ↗</p>
Serie 47.0	Total 141.0	Serie 40.0	Total 141.0
<p>3. Serie Ligg</p> 	<p>1: 9.0 ←</p> <p>2: 9.4 ↘</p> <p>3: 10.4 →</p> <p>4: 10.1 ↗</p> <p>5: 10.6x ↘</p>	<p>4. Serie Ligg</p> 	<p>1: 9.1 →</p> <p>2: 10.3 ↗</p> <p>3: 9.1 ↖</p> <p>4: 10.2 ↘</p> <p>5: 9.8 ↗</p>
Serie 48.0	Total 189.0	Serie 47.0	Total 236.0
<p>5. Serie Ligg</p> 	<p>1: 9.8 ↘</p> <p>2: 9.7 ↗</p> <p>3: 10.2 →</p> <p>4: 10.5x →</p> <p>5: 9.9 ↘</p>		
Serie 47.0	Total 283.0		

Hold	Skive	Dorte Østerby Jakobsen	
555	19		
50 meter afsnit 2		Viborg Skytteforening	LIG
		Landsstævne 2017	Aalborg Skyttekreds
Prøve		1: 10.4 ← 2: 10.1 ↓ 3: 9.8 ↓ 4: 10.6x ← 5: 10.1 ← 6: 10.4x ↓ 7: 10.5x ↑ 8: 10.4x ↑	1. Serie Ligg
			1: 9.7 → 2: 9.9 → 3: 10.2 ↗ 4: 10.4 → 5: 9.7 ↗ 6: 10.2 ↗ 7: 10.7x ↗ 8: 10.6x ↗ 9: 10.0 ↗ 10: 10.6x ←
		Serie 79.0	Serie 97.0
		Total 0.0	Total 97.0
2. Serie Ligg		1: 9.9 ↑ 2: 10.5x ↗ 3: 10.6x ↗ 4: 10.0 ← 5: 9.7 ↗	Prøve
			1: 10.3 ↗ 2: 10.1 ↗ 3: 10.1 ↗ 4: 10.0 ↗ 5: 10.5x ↗
		Serie 48.0	Serie 50.0
		Total 145.0	Total 145.0
3. Serie Ligg		1: 10.2 ← 2: 10.5x ↗ 3: 9.5 ↓ 4: 10.3 ↗ 5: 10.5x ↑	4. Serie Ligg
			1: 10.4x ↘ 2: 10.6x ↓ 3: 10.8x ↓ 4: 10.7x ↓ 5: 10.7x ↘
		Serie 49.0	Serie 50.0
		Total 194.0	Total 244.0
5. Serie Ligg		1: 10.5x ← 2: 10.7x ↓ 3: 10.8x ↑ 4: 10.0 ↗ 5: 10.5x →	
		Serie 50.0	
		Total 294.0	

Hold	Skive	Ole Nielsen	
555	20		
50 meter afsnit 2		Viborg Skytteforening	LIG
Landsstævne 2017		Aalborg Skyttekreds	
Prøve		1. Serie Ligg	
2. Serie Ligg		Prøve	
3. Serie Ligg		4. Serie Ligg	
5. Serie Ligg			

Prøve 	1. Serie Ligg 	1: 10.0 ← 2: 9.8 ← 3: 10.4x ↙ 4: 10.6x → 5: 9.4 ↘ 6: 10.4 ↓ <hr/> Serie 58.0 <hr/> Total 0.0	1: 10.7x ↖ 2: 9.6 ↘ 3: 8.4 → 4: 9.2 ↘ 5: 10.0 ↑ 6: 10.4 ↗ 7: 9.4 ↑ 8: 10.3 ↑ 9: 9.6 ↑ 10: 10.5x ← <hr/> Serie 94.0 <hr/> Total 94.0
2. Serie Ligg 	Prøve 	1: 9.8 ← 2: 10.3 ↗ 3: 10.1 ↘ 4: 9.4 ↑ 5: 10.5x ↑ <hr/> Serie 48.0 <hr/> Total 142.0	1: 10.4x ↘ 2: 9.6 ↘ 3: 9.4 ↑ 4: 9.3 → 5: 10.8x ↗ <hr/> Serie 47.0 <hr/> Total 142.0
3. Serie Ligg 	4. Serie Ligg 	1: 9.6 ↙ 2: 10.5x ↗ 3: 10.0 ↗ 4: 9.4 ← 5: 10.6x ← <hr/> Serie 48.0 <hr/> Total 190.0	1: 9.8 ← 2: 10.5x ↘ 3: 10.6x ↗ 4: 10.7x ← 5: 8.9 ↑ <hr/> Serie 47.0 <hr/> Total 237.0
5. Serie Ligg 		1: 10.1 ← 2: 10.0 ↘ 3: 10.5x ↗ 4: 9.9 ↗ 5: 9.6 ↑ <hr/> Serie 48.0 <hr/> Total 285.0	

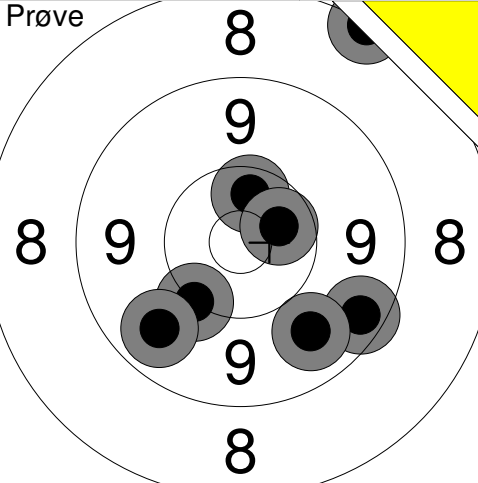
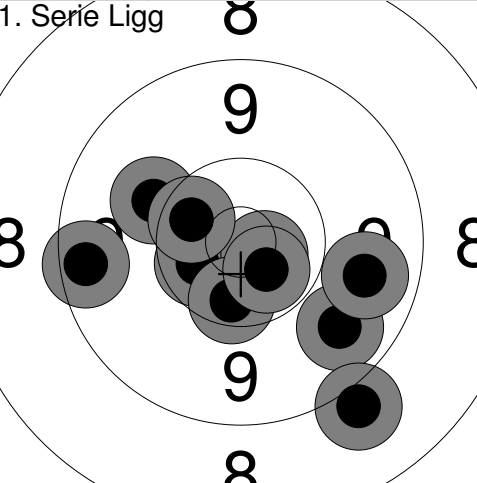
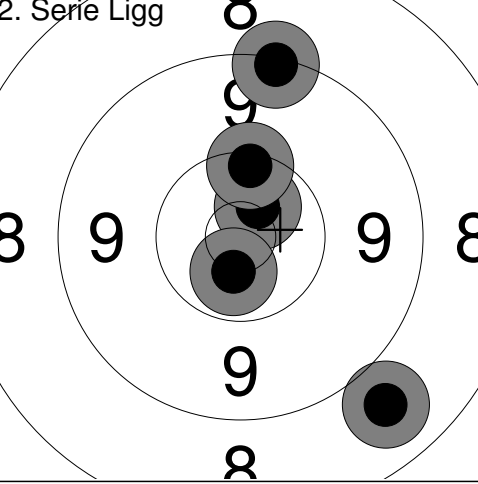
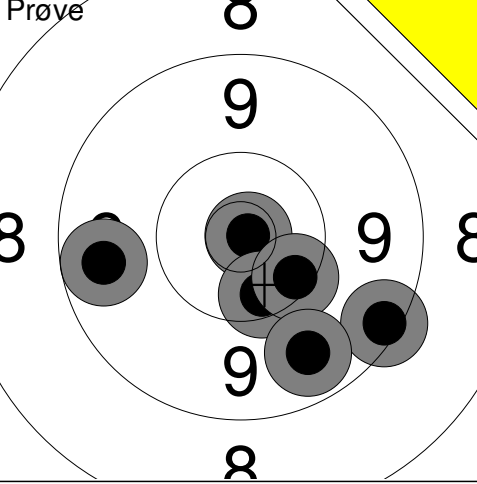
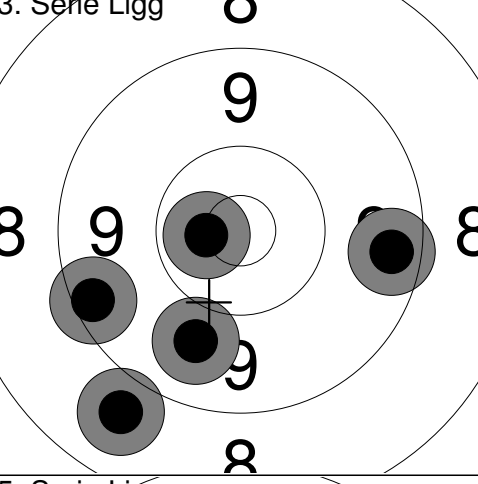
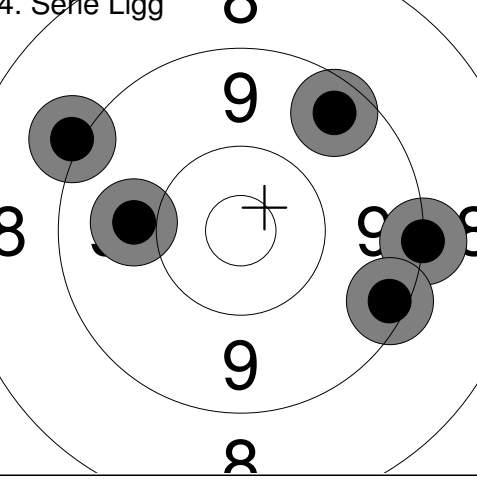
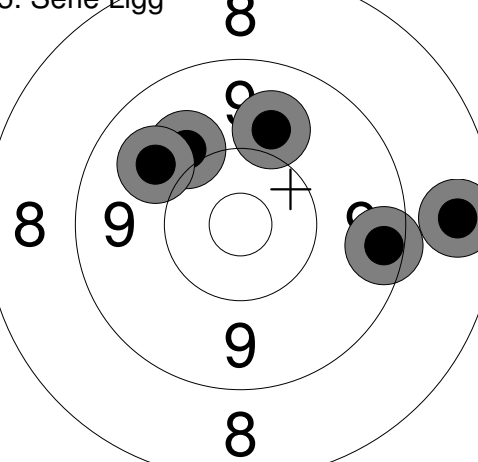
Hold	Skive	John Petersen	
556	14		
50 meter afsnit 2		Lyngby Skyttekreds	LIG
Landsstævne 2017		Aalborg Skyttekreds	
Prøve		1: 10.2 ↙ 2: 9.7 ↙ 3: 9.5 → 4: 10.4x ↑ 5: 8.2 ↗ 6: 10.5x → 7: 9.7 ↘	1. Serie Ligg
		Serie 65.0 Total 0.0	
			1: 10.0 ↗ 2: 10.5x ↙ 3: 10.7x ↘ 4: 9.4 ← 5: 10.4 ↘ 6: 9.7 ↘ 7: 9.0 ↘ 8: 10.4x ↗ 9: 10.6x ↘ 10: 9.7 ↘
			Serie 96.0 Total 96.0
2. Serie Ligg		1: 10.6x ↗ 2: 10.6x ↘ 3: 9.2 ↗ 4: 10.3 ↗ 5: 8.8 ↘	Prøve
		Serie 47.0 Total 143.0	
			1: 10.9x → 2: 9.3 ↘ 3: 10.4 ↘ 4: 10.3 ↘ 5: 9.6 ← 6: 9.7 ↘
			Serie 57.0 Total 143.0
3. Serie Ligg		1: 9.4 ← 2: 10.6x ← 3: 9.5 → 4: 8.8 ↘ 5: 9.8 ↘	4. Serie Ligg
		Serie 45.0 Total 188.0	
			1: 9.2 → 2: 9.1 ↗ 3: 9.9 ← 4: 9.4 ↘ 5: 9.5 ↗
			Serie 45.0 Total 233.0
5. Serie Ligg		1: 8.6 → 2: 10.0 ↗ 3: 9.9 ↗ 4: 9.4 → 5: 9.9 ↗	
		Serie 45.0 Total 278.0	

Hold	Skive	René Olsen	
556	15	50 meter afsnit 2	Lyngby Skyttekreds
		Landsstævne 2017	Aalborg Skyttekreds
Prøve		1: 9.6 → 2: 8.9 ↗ 3: 10.4 → 4: 8.6 ↖ 5: 10.1 ↗ 6: 9.9 ↗ 7: 9.8 ↗ 8: 9.1 ← 9: 10.4x ↘ 10: 10.1 ↗ Serie 92.0 Total 0.0	1. Serie Ligg
			1: 9.8 ↘ 2: 10.2 ↘ 3: 9.3 ↘ 4: 10.2 ↘ 5: 10.4 ↘ 6: 9.7 ↘ 7: 9.9 ↘ 8: 10.6x → 9: 10.2 ↘ 10: 10.1 ↘ Serie 96.0 Total 96.0
2. Serie Ligg		1: 10.2 ↓ 2: 8.3 ↖ 3: 10.1 ↓ 4: 10.4 ↖ 5: 10.4x ↗	Prøve
			1: 7.9 ↘ 2: 10.5x ↘ 3: 9.8 ↘ 4: 9.8 ↗ 5: 9.7 ↘ Serie 44.0 Total 144.0
3. Serie Ligg		1: 9.3 ↓ 2: 9.1 ↓ 3: 10.1 ↖ 4: 10.5x ↖ 5: 10.2 ↗	4. Serie Ligg
			1: 7.6 → 2: 9.3 → 3: 10.8x ↘ 4: 10.5x ↘ 5: 10.1 ↗ Serie 46.0 Total 238.0
5. Serie Ligg		1: 10.2 ↓ 2: 9.8 ↗ 3: 9.9 ↗ 4: 8.8 ↘ 5: 10.3 ↗	
		Serie 46.0 Total 284.0	

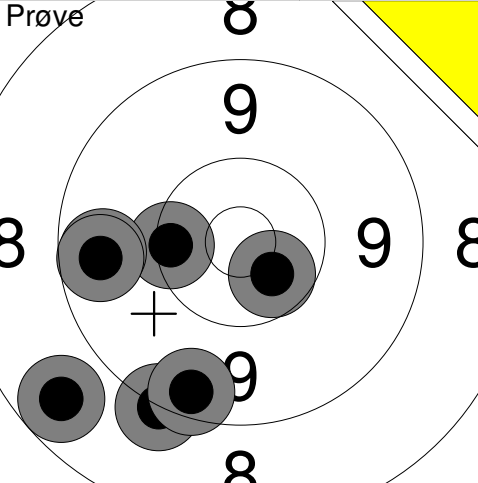
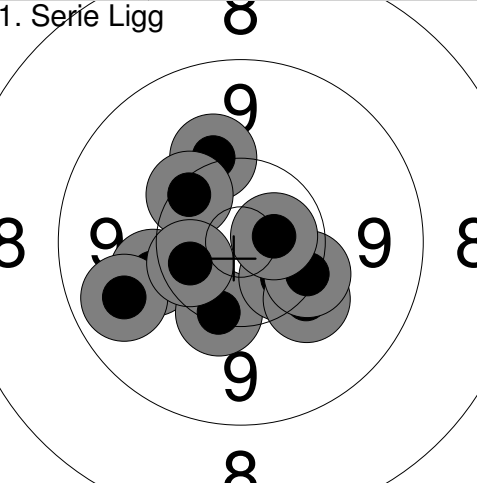
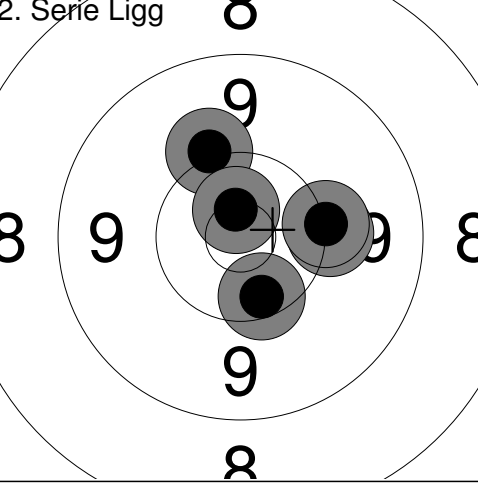
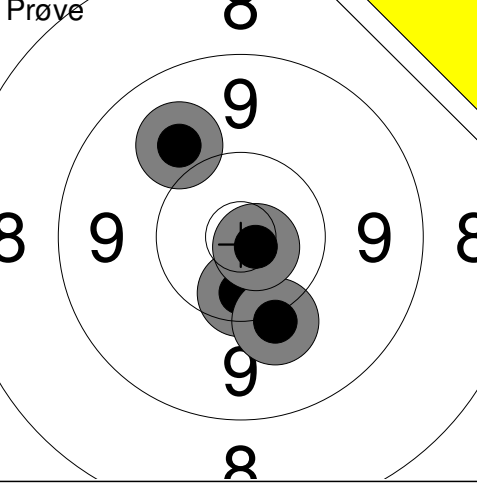
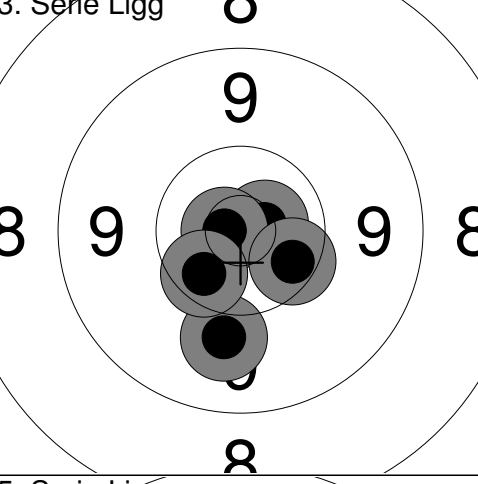
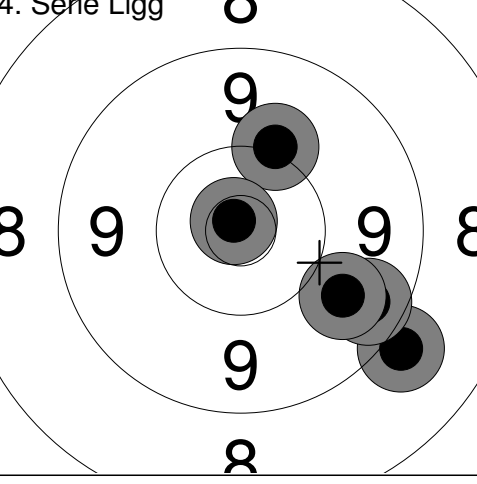
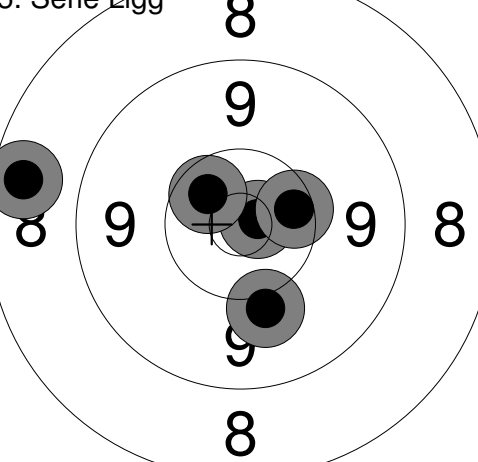
Hold	Skive	Lis Andersen	
556	16		
50 meter afsnit 2		Jelling fS Skydning	LIG
		Landsstævne 2017	Aalborg Skyttekreds
Prøve		1: 10.3 ← 2: 9.2 ↓ 3: 9.4 ↓ 4: 8.6 ↓ 5: 9.6 ← 6: 10.5x ↓ 7: 9.6 ← Serie 64.0 Total 0.0	1. Serie Ligg  1: 10.1 ← 2: 10.3 ↓ 3: 10.1 ↑ 4: 10.4x ↓ 5: 10.1 ↓ 6: 10.3 ↓ 7: 9.7 ← 8: 10.3 ↑ 9: 10.6x → 10: 10.4x ← Serie 99.0 Total 99.0
2. Serie Ligg		1: 10.1 ↑ 2: 10.1 → 3: 10.4 ↓ 4: 10.1 → 5: 10.7x ↑ Serie 50.0 Total 149.0	Prøve  1: 10.4x ↓ 2: 10.1 ↓ 3: 10.8x ↓ 4: 9.9 ↑ Serie 39.0 Total 149.0
3. Serie Ligg		1: 10.7x → 2: 10.8x ← 3: 10.4 ↓ 4: 9.9 ↓ 5: 10.4x ↓ Serie 49.0 Total 198.0	4. Serie Ligg  1: 10.1 ↑ 2: 9.0 ↓ 3: 9.5 ↓ 4: 9.8 ↓ 5: 10.8x ↑ Serie 47.0 Total 245.0
5. Serie Ligg		1: 10.8x → 2: 10.4 → 3: 8.5 ← 4: 10.0 ↓ 5: 10.5x ↑ Serie 48.0 Total 293.0	

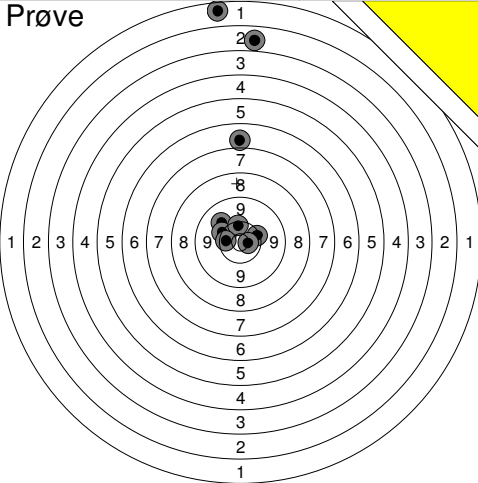
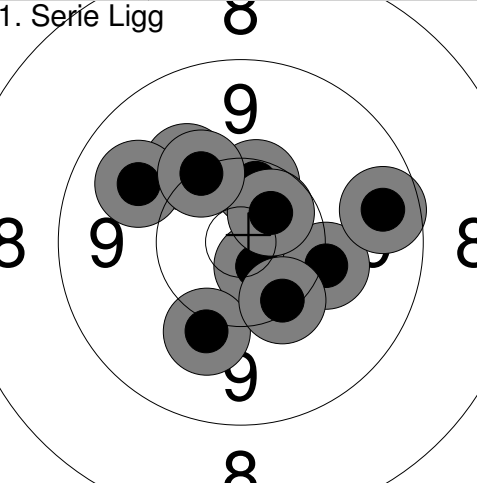
<b>Prøve</b> 	1: 2.8 ↑ 2: 1.5 ↑ 3: 6.9 ↑ 4: 9.9 ↗ 5: 10.4 ↗ 6: 10.3 → 7: 10.7x → 8: 10.2 ↗ 9: 10.3 ↑ 10: 10.4 ← <hr/> Serie 78.0 Total 0.0	<b>1. Serie Ligg</b> 	1: 10.1 ↗ 2: 9.8 ↗ 3: 10.4 ↑ 4: 10.7x ↓ 5: 10.1 → 6: 10.1 ↓ 7: 10.6x ↗ 8: 9.6 → 9: 10.3 ↓ 10: 10.2 ↗ <hr/> Serie 98.0 Total 98.0
--	---	--	---

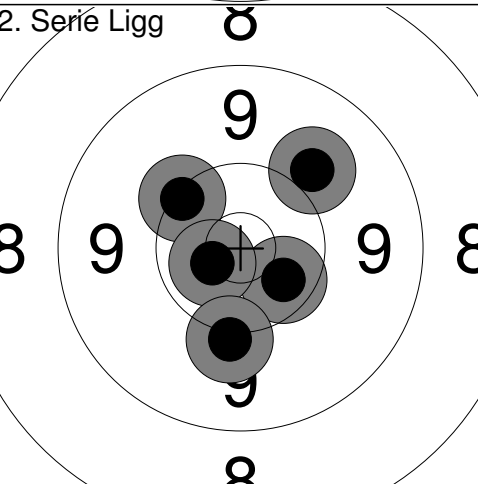
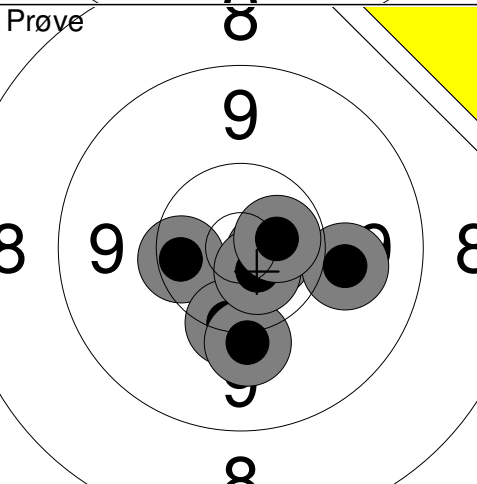
<b>2. Serie Ligg</b> 	1: 10.5x ↓ 2: 10.2 ↗ 3: 10.7x ← 4: 10.1 ↓ 5: 10.0 ↗ <hr/> Serie 50.0 Total 148.0	<b>Prøve</b> 	1: 10.4 ← 2: 10.7x → 3: 10.2 ↓ 4: 10.1 ↓ 5: 10.0 → 6: 10.7x ↓ 7: 10.6x → <hr/> Serie 70.0 Total 148.0
---	--	---	---

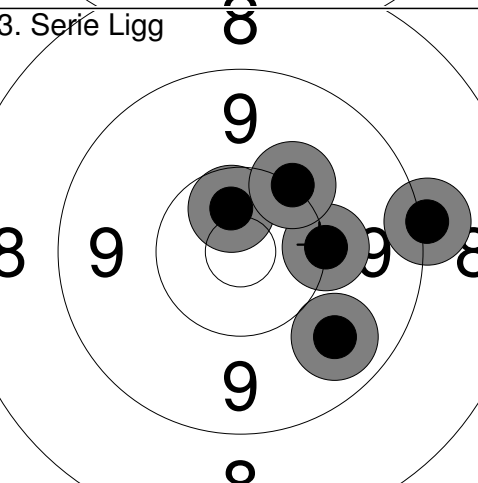
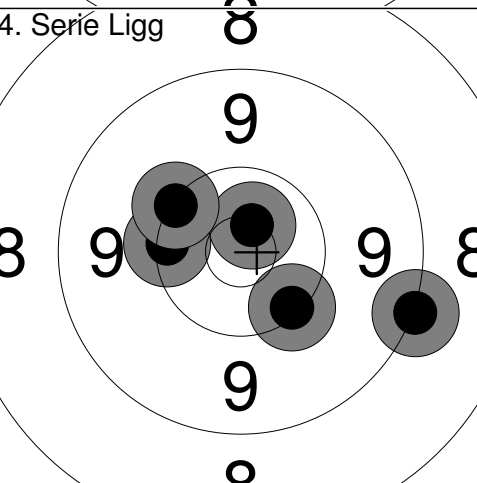
<b>3. Serie Ligg</b> 	1: 10.5x ↑ 2: 9.1 → 3: 10.1 → 4: 10.2 ↗ 5: 9.7 ↓ <hr/> Serie 48.0 Total 196.0	<b>4. Serie Ligg</b> 	1: 10.7x ↑ 2: 10.2 ↓ 3: 9.2 → 4: 10.3 ← 5: 10.2 ↗ <hr/> Serie 49.0 Total 245.0
--	---	--	--

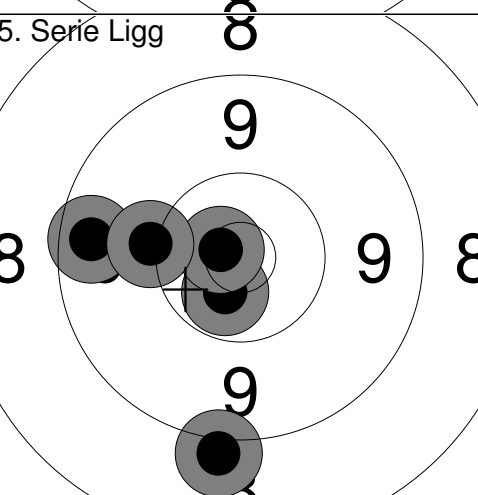
<b>5. Serie Ligg</b> 	1: 9.5 ← 2: 10.6x ↓ 3: 10.8x ↗ 4: 9.0 ↓ 5: 10.1 ← <hr/> Serie 48.0 Total 293.0	
--	--	--

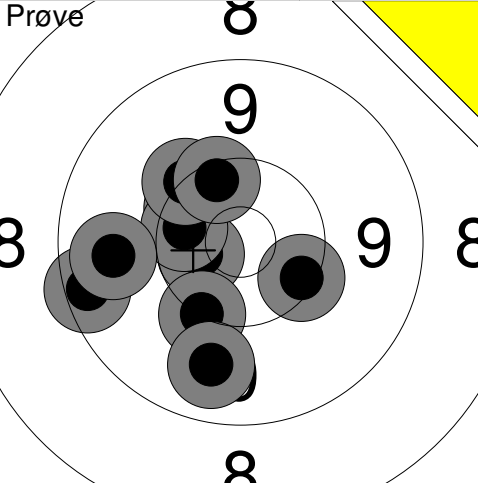
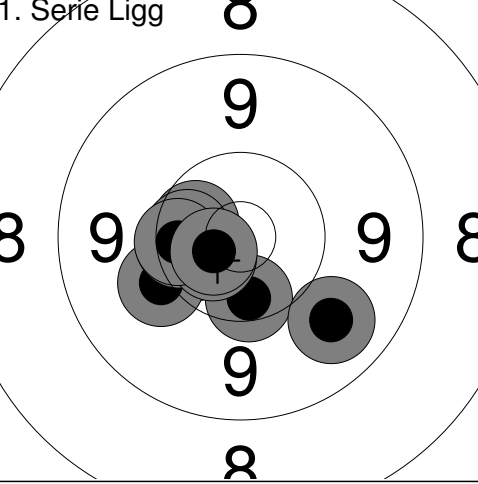
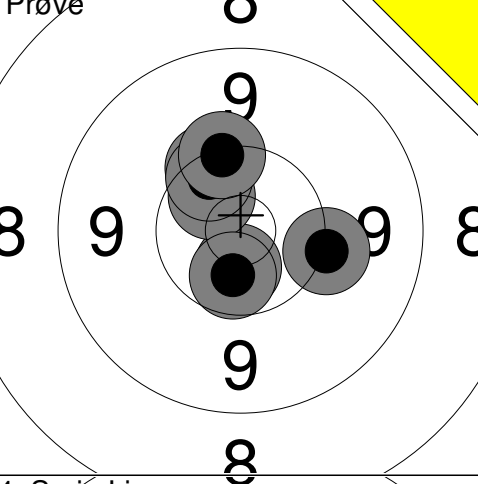
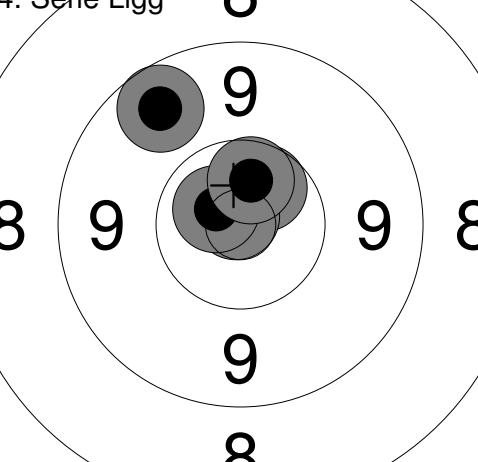

Hold	Skive	Emil Olsen	
556	18	Ammitsbøl SG&I	
50 meter afsnit 2		LIG	
Landsstævne 2017		Aalborg Skyttekreds	
Prøve		1. Serie Ligg	
	1: 8.6 ↖ 2: 10.1 ↘ 3: 10.4x → 4: 10.4x ↗ 5: 10.3 ↑ 6: 10.5x ↗ 7: 10.7x ↖ 8: 10.7x ↖		1: 10.2 ↖ 2: 9.7 ↗ 3: 10.7x ↗ 4: 10.3 → 5: 9.7 ↗ 6: 10.5x ↘ 7: 10.8x ↖ 8: 10.5x ↖ 9: 9.8 ↗ 10: 10.3 ↑
	Serie 78.0		Serie 97.0
	Total 0.0		Total 97.0
2. Serie Ligg		Prøve	
	1: 10.1 → 2: 10.7x ↘ 3: 10.4x ↗ 4: 10.7x ↗ 5: 10.6x ↗		1: 10.5x → 2: 10.5x ↘ 3: 10.3 ↑ 4: 10.1 ↑ 5: 9.8 ↗ 6: 10.1 ↑
	Serie 50.0		Serie 59.0
	Total 147.0		Total 147.0
3. Serie Ligg		4. Serie Ligg	
	1: 10.6x ↗ 2: 9.9 ↑ 3: 9.5 ↑ 4: 10.2 ↘ 5: 10.6x ↖		1: 10.2 ↘ 2: 10.5x ↘ 3: 10.0 → 4: 10.3 ↘ 5: 9.7 ↖
	Serie 48.0		Serie 49.0
	Total 195.0		Total 244.0
5. Serie Ligg			
	1: 10.1 ↘ 2: 10.4 ↗ 3: 10.8x ↘ 4: 9.7 ↗ 5: 10.2 ↗		
	Serie 49.0		
	Total 293.0		

Hold	Skive	Lisbeth Stricker Jensen	
556	19	Lisbeth Stricker Jensen	
50 meter afsnit 2		Vodskov Skytteforening	LIG
		Landsstævne 2017	Aalborg Skyttekreds
Prøve		1: 10.4 ↗ 2: 10.6x ← 3: 10.3 ↘ 4: 10.4 ↗ 5: 10.2 ↗ 6: 10.3 ↗ 7: 9.4 ← 8: 10.2 ↓ 9: 9.8 ↓ 10: 9.7 ←	Prøve
		Serie 97.0	11: 10.5x ↗
		Total 0.0	Serie 10.0
			Total 0.0
1. Serie Ligg		1: 10.4 ↓ 2: 10.5x ← 3: 10.1 ← 4: 10.5x ↗ 5: 10.5x ← 6: 10.4 ← 7: 9.8 ↓ 8: 10.6x ↓ 9: 10.4 ← 10: 10.7x ←	2. Serie Ligg
		Serie 99.0	1: 10.8x ↓
		Total 99.0	2: 9.6 ←
			3: 10.8x ↗
			4: 10.4x ←
			5: 10.5x ←
			Serie 49.0
			Total 148.0
Prøve		1: 10.6x ↓ 2: 10.1 → 3: 10.5x ↗ 4: 10.3 ↗ 5: 10.5x ↓ 6: 10.4 ↗ 7: 10.2 ↗	3. Serie Ligg
		Serie 70.0	1: 10.5x ↗
		Total 148.0	2: 10.0 ↗
			3: 10.7x ↓
			4: 10.6x →
			5: 10.5x ←
			Serie 50.0
			Total 198.0
4. Serie Ligg		1: 10.5x ↗ 2: 9.6 ↗ 3: 10.9x ↗ 4: 10.7x ↗ 5: 10.5x ↗	5. Serie Ligg
		Serie 49.0	1: 10.5x ↓
		Total 247.0	2: 10.3 ↗
			3: 10.6x ↗
			4: 10.0 ↓
			5: 9.8 ←
			Serie 49.0
			Total 296.0

Hold	Skive	Trine Weinreich Klit Andersen	
556	20		
50 meter afsnit 2		Vester Hassing Skf.	BK
		Landsstævne 2017	Aalborg Skyttekreds
Prøve		1: 10.3 ↗ 2: 10.4 ↓ 3: 9.4 ↓ 4: 10.1 ↓ 5: 10.1 ↓ 6: 9.9 ↓ 7: 10.4x ← 8: 10.7x ↓ 9: 10.4 ↗	1. Serie Ligg
			1: 10.7x ↗ 2: 10.6x → 3: 10.8x ↗ 4: 10.6x ← 5: 10.9x ← 6: 10.2 ← 7: 10.6x → 8: 10.7x ↗ 9: 10.7x ← 10: 10.3 →
		Serie 88.0	Serie 100.0
		Total 0.0	Total 100.0
2. Serie Ligg		1: 9.9 → 2: 10.7x → 3: 10.4x ← 4: 10.5x → 5: 10.0 ↗	Prøve
			1: 9.4 ↗ 2: 10.7x → 3: 10.5x → 4: 10.2 ↗ 5: 10.2 ↗ 6: 10.4 → 7: 10.8x ↗ 8: 10.2 ↗
		Serie 49.0	Serie 79.0
		Total 149.0	Total 149.0
3. Serie Ligg		1: 10.1 ↗ 2: 10.6x ← 3: 10.8x ← 4: 10.4 ↗ 5: 10.4 ↗	4. Serie Ligg
			1: 10.7x ← 2: 10.7x ↗ 3: 10.8x ↓ 4: 10.4x → 5: 10.4 ↗
		Serie 50.0	Serie 50.0
		Total 199.0	Total 249.0
5. Serie Ligg		1: 10.4 ← 2: 10.3 ↓ 3: 10.6x → 4: 9.9 ↓ 5: 10.5x ↓	
		Serie 49.0	
		Total 298.0	

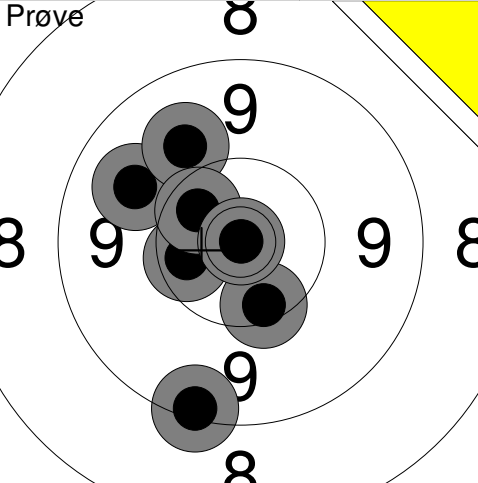
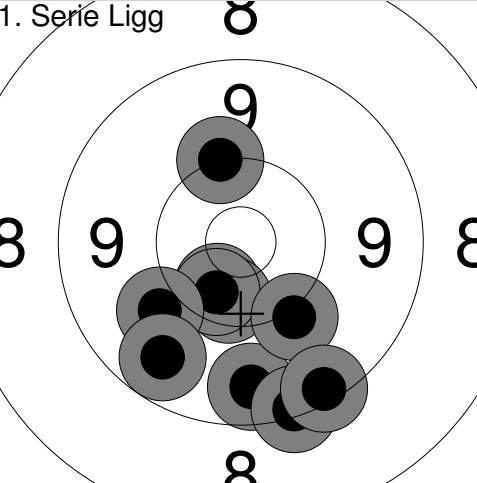
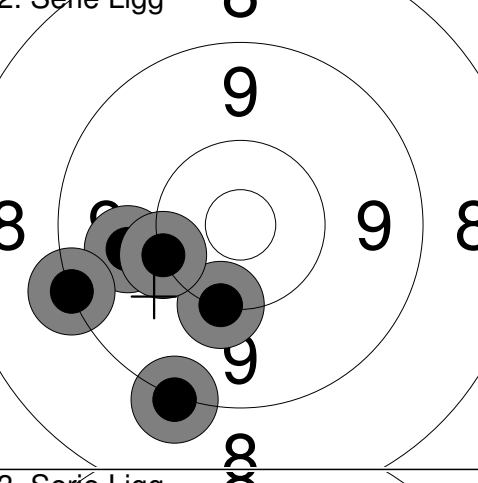
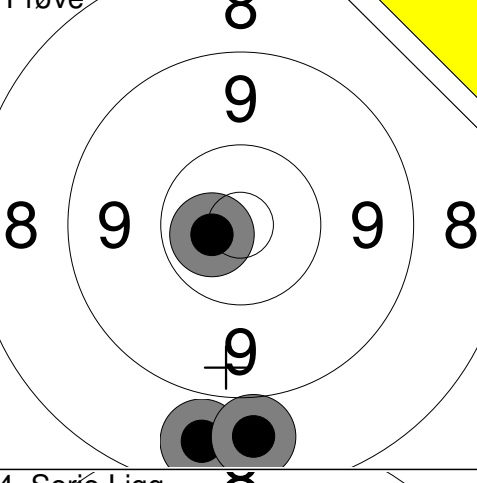
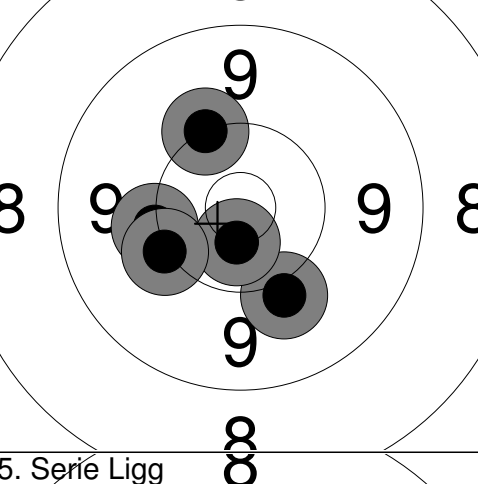
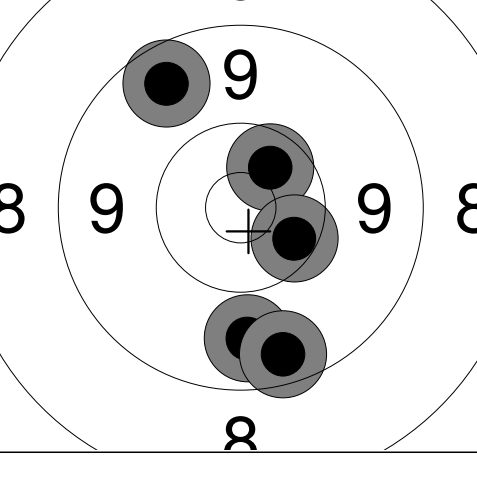
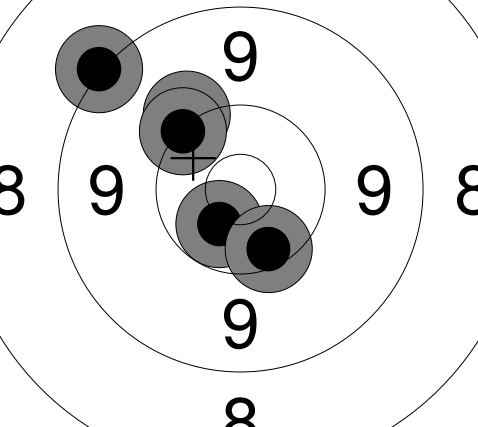
Hold	Skive	Julie Olsen	
557	13	Lyngby Skyttekreds	
50 meter afsnit 2		LIG	
Landsstævne 2017		Aalborg Skyttekreds	
Prøve		1: 9.8 ↖ 2: 9.9 ↗ 3: 10.3 ↘ 4: 10.4x ← 5: 9.3 ↘ 6: 10.5x ↗ 7: 10.9x ↗	1. Serie Ligg
		Serie 67.0	
		Total 0.0	1: 10.2 ↗ 2: 9.6 ↘ 3: 10.5x ↘ 4: 9.3 ↘ 5: 10.4 ↘ 6: 10.4x ↘ 7: 10.1 ↘ 8: 9.3 ↘ 9: 10.0 ← 10: 9.6 ↘
2. Serie Ligg		1: 10.2 ↘ 2: 9.1 ↘ 3: 9.9 ← 4: 10.2 ← 5: 9.2 ←	Prøve
		Serie 47.0	
		Total 143.0	1: 8.7 ↘ 2: 8.8 ↘ 3: 10.7x ←
3. Serie Ligg		1: 10.0 ↘ 2: 10.2 ↗ 3: 10.1 ← 4: 10.6x ↘ 5: 10.1 ←	4. Serie Ligg
		Serie 50.0	
		Total 193.0	1: 9.7 ↘ 2: 9.5 ↘ 3: 9.6 ↗ 4: 10.5x ↗ 5: 10.4 ↘
5. Serie Ligg		1: 10.1 ↗ 2: 10.6x ↘ 3: 10.3 ↘ 4: 10.2 ↗ 5: 9.2 ↗	
		Serie 49.0	
		Total 289.0	

<p>Prøve </p>	<p>Prøve </p>	<table style="width:100%; border-collapse: collapse;"> <tr> <td style="width:50%;">1: 6.5 ↗</td> <td style="width:50%;">11: 10.1 ↘</td> </tr> <tr> <td>2: 8.8 ↗</td> <td>12: 10.3 →</td> </tr> <tr> <td>3: 10.1 ↗</td> <td></td> </tr> <tr> <td>4: 8.3 ↗</td> <td></td> </tr> <tr> <td>5: 9.3 ↗</td> <td></td> </tr> <tr> <td>6: 9.5 ↗</td> <td></td> </tr> <tr> <td>7: 9.5 ↗</td> <td></td> </tr> <tr> <td>8: 10.1 ↗</td> <td></td> </tr> <tr> <td>9: 9.2 ↘</td> <td></td> </tr> <tr> <td>10: 10.3 ↘</td> <td></td> </tr> <tr> <td style="border-top: 1px solid black;">Serie 88.0</td> <td style="border-top: 1px solid black;">Serie 20.0</td> </tr> <tr> <td style="border-top: 1px solid black;">Total 0.0</td> <td style="border-top: 1px solid black;">Total 0.0</td> </tr> </table>	1: 6.5 ↗	11: 10.1 ↘	2: 8.8 ↗	12: 10.3 →	3: 10.1 ↗		4: 8.3 ↗		5: 9.3 ↗		6: 9.5 ↗		7: 9.5 ↗		8: 10.1 ↗		9: 9.2 ↘		10: 10.3 ↘		Serie 88.0	Serie 20.0	Total 0.0	Total 0.0
1: 6.5 ↗	11: 10.1 ↘																									
2: 8.8 ↗	12: 10.3 →																									
3: 10.1 ↗																										
4: 8.3 ↗																										
5: 9.3 ↗																										
6: 9.5 ↗																										
7: 9.5 ↗																										
8: 10.1 ↗																										
9: 9.2 ↘																										
10: 10.3 ↘																										
Serie 88.0	Serie 20.0																									
Total 0.0	Total 0.0																									

<p>1. Serie Ligg </p>	<p>2. Serie Ligg </p>	<table style="width:100%; border-collapse: collapse;"> <tr> <td style="width:50%;">1: 10.0 ↗</td> <td style="width:50%;">1: 10.4 ←</td> </tr> <tr> <td>2: 9.6 ↘</td> <td>2: 10.8x ↗</td> </tr> <tr> <td>3: 10.0 →</td> <td>3: 9.5 ↘</td> </tr> <tr> <td>4: 9.9 ↗</td> <td>4: 10.3 ↗</td> </tr> <tr> <td>5: 10.0 ↗</td> <td>5: 10.8x ↘</td> </tr> <tr> <td>6: 10.3 ↗</td> <td></td> </tr> <tr> <td>7: 9.2 →</td> <td></td> </tr> <tr> <td>8: 10.1 ↗</td> <td></td> </tr> <tr> <td>9: 9.8 ↗</td> <td></td> </tr> <tr> <td>10: 10.3 ↗</td> <td></td> </tr> <tr> <td style="border-top: 1px solid black;">Serie 96.0</td> <td style="border-top: 1px solid black;">Serie 49.0</td> </tr> <tr> <td style="border-top: 1px solid black;">Total 96.0</td> <td style="border-top: 1px solid black;">Total 145.0</td> </tr> </table>	1: 10.0 ↗	1: 10.4 ←	2: 9.6 ↘	2: 10.8x ↗	3: 10.0 →	3: 9.5 ↘	4: 9.9 ↗	4: 10.3 ↗	5: 10.0 ↗	5: 10.8x ↘	6: 10.3 ↗		7: 9.2 →		8: 10.1 ↗		9: 9.8 ↗		10: 10.3 ↗		Serie 96.0	Serie 49.0	Total 96.0	Total 145.0
1: 10.0 ↗	1: 10.4 ←																									
2: 9.6 ↘	2: 10.8x ↗																									
3: 10.0 →	3: 9.5 ↘																									
4: 9.9 ↗	4: 10.3 ↗																									
5: 10.0 ↗	5: 10.8x ↘																									
6: 10.3 ↗																										
7: 9.2 →																										
8: 10.1 ↗																										
9: 9.8 ↗																										
10: 10.3 ↗																										
Serie 96.0	Serie 49.0																									
Total 96.0	Total 145.0																									

<p>Prøve </p>	<p>3. Serie Ligg </p>	<table style="width:100%; border-collapse: collapse;"> <tr> <td style="width:50%;">1: 9.2 ↘</td> <td style="width:50%;">1: 10.1 ←</td> </tr> <tr> <td>2: 10.5x ↘</td> <td>2: 10.6x →</td> </tr> <tr> <td>3: 10.3 ↗</td> <td>3: 10.6x ↘</td> </tr> <tr> <td>4: 9.9 ↘</td> <td>4: 10.4x ←</td> </tr> <tr> <td></td> <td>5: 10.1 ←</td> </tr> <tr> <td style="border-top: 1px solid black;">Serie 38.0</td> <td style="border-top: 1px solid black;">Serie 50.0</td> </tr> <tr> <td style="border-top: 1px solid black;">Total 145.0</td> <td style="border-top: 1px solid black;">Total 195.0</td> </tr> </table>	1: 9.2 ↘	1: 10.1 ←	2: 10.5x ↘	2: 10.6x →	3: 10.3 ↗	3: 10.6x ↘	4: 9.9 ↘	4: 10.4x ←		5: 10.1 ←	Serie 38.0	Serie 50.0	Total 145.0	Total 195.0
1: 9.2 ↘	1: 10.1 ←															
2: 10.5x ↘	2: 10.6x →															
3: 10.3 ↗	3: 10.6x ↘															
4: 9.9 ↘	4: 10.4x ←															
	5: 10.1 ←															
Serie 38.0	Serie 50.0															
Total 145.0	Total 195.0															

<p>4. Serie Ligg </p>	<p>5. Serie Ligg </p>	<table style="width:100%; border-collapse: collapse;"> <tr> <td style="width:50%;">1: 9.8 ←</td> <td style="width:50%;">1: 9.9 ↗</td> </tr> <tr> <td>2: 9.7 ↘</td> <td>2: 10.3 ←</td> </tr> <tr> <td>3: 8.8 ↘</td> <td>3: 10.8x ↗</td> </tr> <tr> <td>4: 10.4 ↘</td> <td>4: 10.4 ←</td> </tr> <tr> <td>5: 10.1 ↗</td> <td>5: 10.1 ↗</td> </tr> <tr> <td style="border-top: 1px solid black;">Serie 46.0</td> <td style="border-top: 1px solid black;">Serie 49.0</td> </tr> <tr> <td style="border-top: 1px solid black;">Total 241.0</td> <td style="border-top: 1px solid black;">Total 290.0</td> </tr> </table>	1: 9.8 ←	1: 9.9 ↗	2: 9.7 ↘	2: 10.3 ←	3: 8.8 ↘	3: 10.8x ↗	4: 10.4 ↘	4: 10.4 ←	5: 10.1 ↗	5: 10.1 ↗	Serie 46.0	Serie 49.0	Total 241.0	Total 290.0
1: 9.8 ←	1: 9.9 ↗															
2: 9.7 ↘	2: 10.3 ←															
3: 8.8 ↘	3: 10.8x ↗															
4: 10.4 ↘	4: 10.4 ←															
5: 10.1 ↗	5: 10.1 ↗															
Serie 46.0	Serie 49.0															
Total 241.0	Total 290.0															

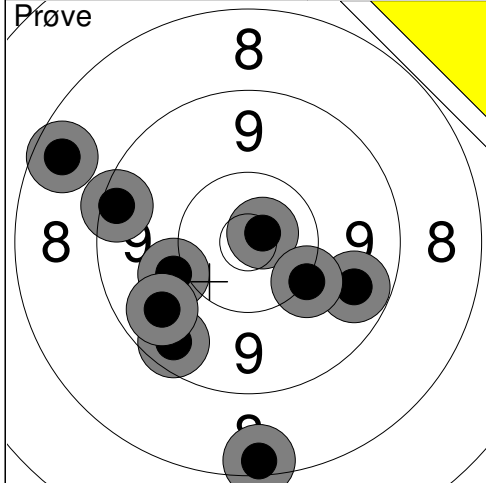

1:	10.8x	↗
2:	8.5	↖
3:	9.5	↘
4:	9.4	↖
5:	10.0	↖
6:	9.7	↘
7:	9.6	↘
8:	8.4	↘
9:	10.2	↘

Serie	82.0
Total	0.0

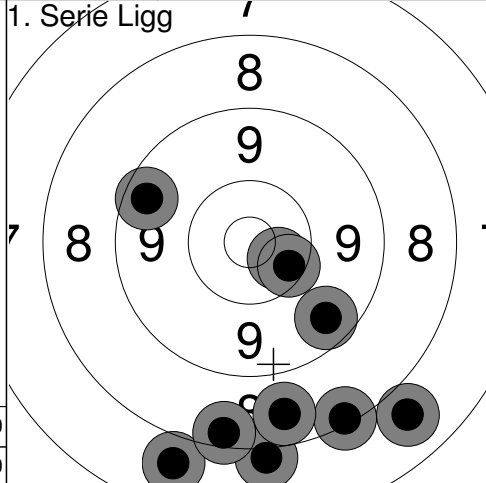

1:	10.5x	↗
2:	7.8	↘
3:	8.3	↘
4:	9.5	↘
5:	8.0	↘
6:	9.5	↗
7:	10.4	↗
8:	8.6	↘
9:	7.8	↘
10:	8.4	↘

Serie	84.0
Total	84.0

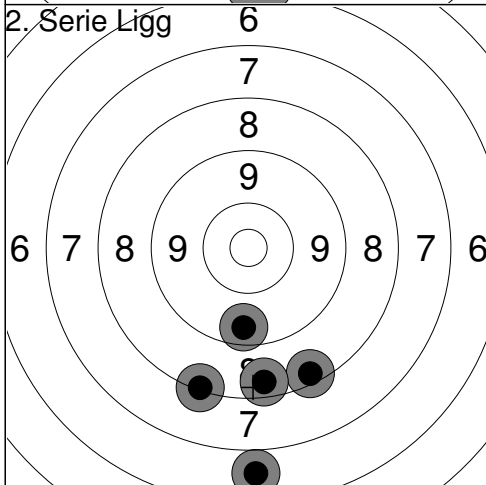

1:	6.7	↘
2:	8.4	↘
3:	8.2	↘
4:	9.5	↘
5:	8.5	↘

Serie	39.0
Total	123.0

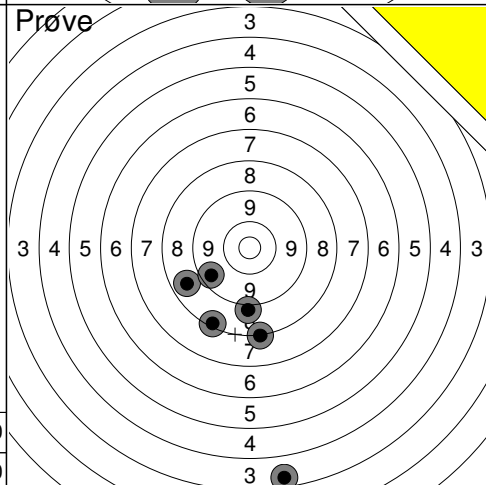

1:	8.3	↘
2:	3.5	↘
3:	9.0	↘
4:	8.7	↖
5:	8.2	↘
6:	9.5	↖

Serie	45.0
Total	123.0

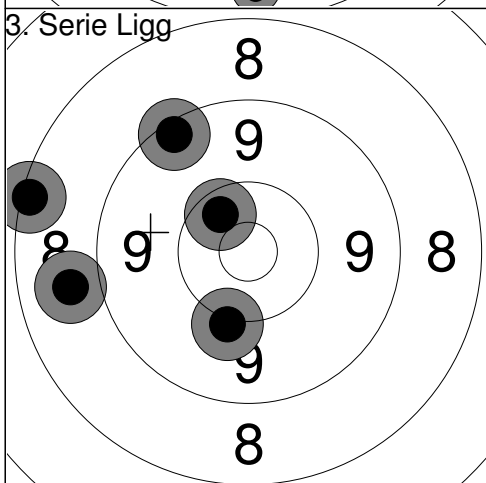

1:	8.8	↖
2:	9.3	↗
3:	10.1	↘
4:	8.3	↖
5:	10.4x	↗

Serie	45.0
Total	168.0

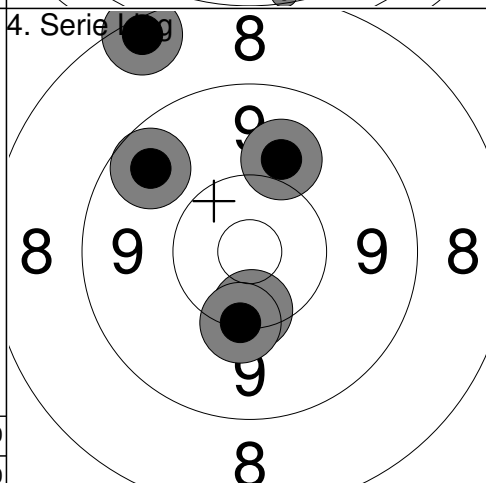

1:	9.9	↗
2:	10.4	↘
3:	10.2	↘
4:	8.4	↗
5:	9.6	↗

Serie	46.0
Total	214.0

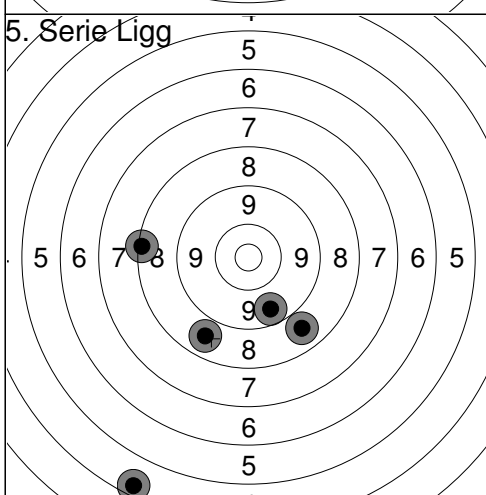

1:	9.6	↘
2:	8.7	↘
3:	8.3	↖
4:	8.7	↘
5:	4.4	↘

Serie	37.0
Total	251.0

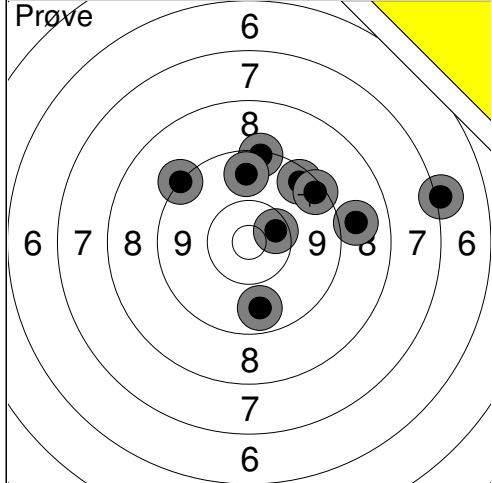

1:	9.3	↑
2:	9.7	↑
3:	9.2	↖
4:	9.5	↗
5:	9.7	↓
6:	9.4	↗
7:	5.5	↗
8:	8.8	→
9:	10.4x	→
10:	7.1	→
<b>Serie</b>		<b>84.0</b>
<b>Total</b>		<b>0.0</b>

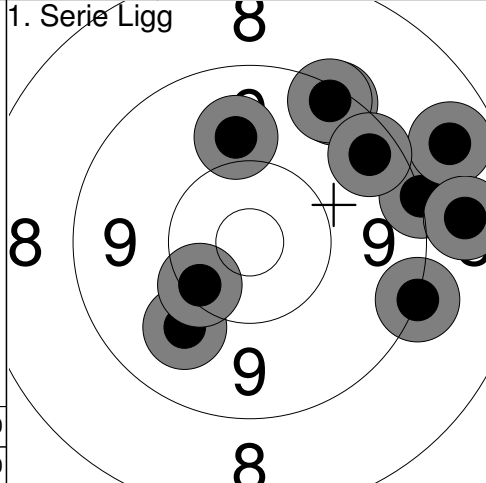

1:	9.3	↗
2:	9.2	→
3:	9.3	↗
4:	8.7	↗
5:	9.9	↑
6:	9.5	↗
7:	8.8	→
8:	9.2	→
9:	9.9	↓
10:	10.3	↙
<b>Serie</b>		<b>89.0</b>
<b>Total</b>		<b>89.0</b>

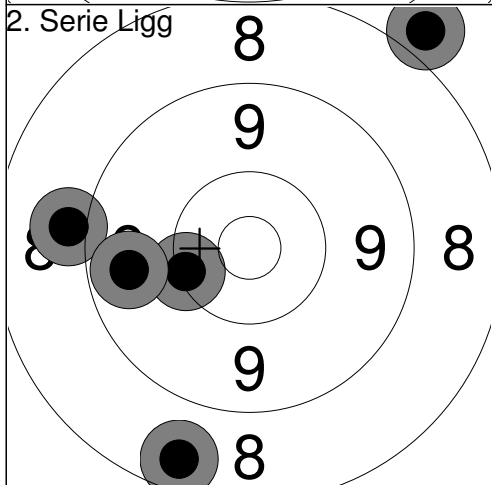

1:	9.0	←
2:	10.2	←
3:	9.7	←
4:	8.5	↓
5:	7.9	↗
<b>Serie</b>		<b>43.0</b>
<b>Total</b>		<b>132.0</b>

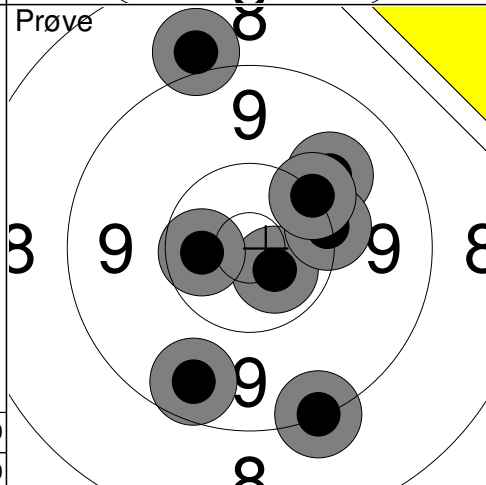

1:	9.2	↓
2:	9.6	↓
3:	10.6x	↘
4:	10.5x	←
5:	9.9	↗
6:	10.2	→
7:	10.2	↗
8:	9.0	↑
<b>Serie</b>		<b>76.0</b>
<b>Total</b>		<b>132.0</b>

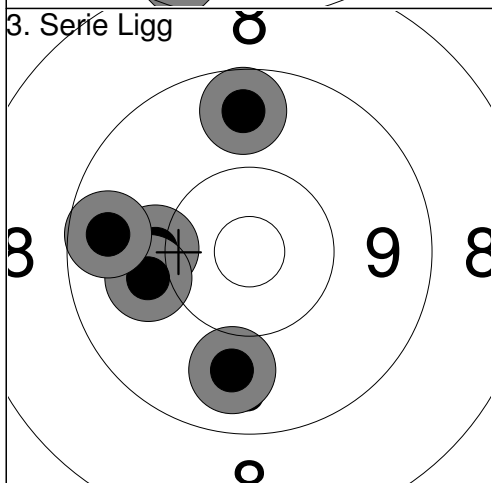

1:	9.8	↓
2:	10.1	←
3:	10.0	←
4:	9.6	←
5:	9.6	↑
<b>Serie</b>		<b>47.0</b>
<b>Total</b>		<b>179.0</b>

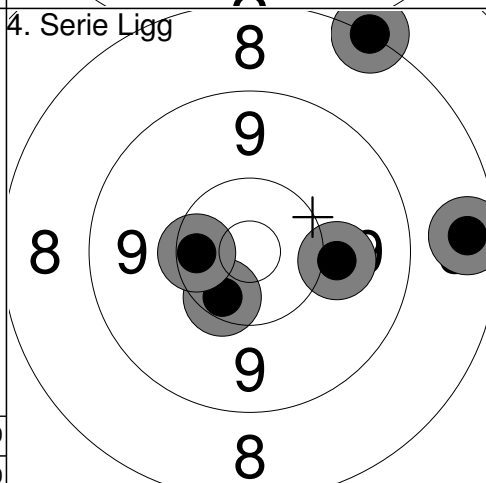

1:	8.2	↗
2:	8.5	→
3:	10.4	↘
4:	10.0	→
5:	10.4	←
<b>Serie</b>		<b>46.0</b>
<b>Total</b>		<b>225.0</b>

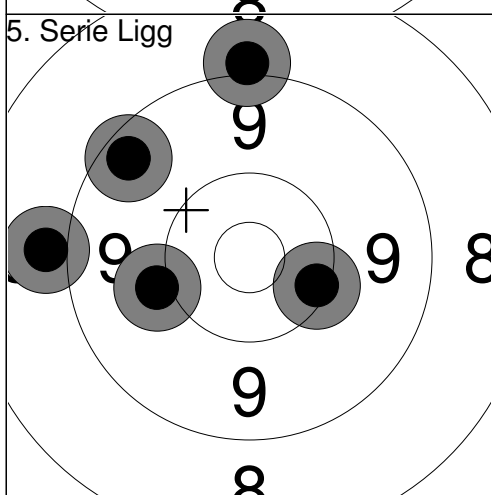

1:	9.1	↑
2:	10.0	←
3:	10.3	↘
4:	9.4	↗
5:	9.0	←
<b>Serie</b>		<b>47.0</b>
<b>Total</b>		<b>272.0</b>

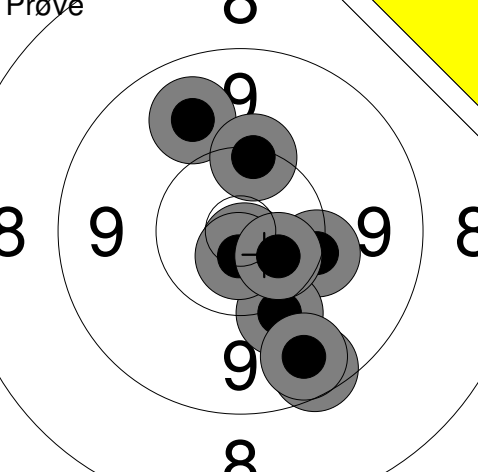
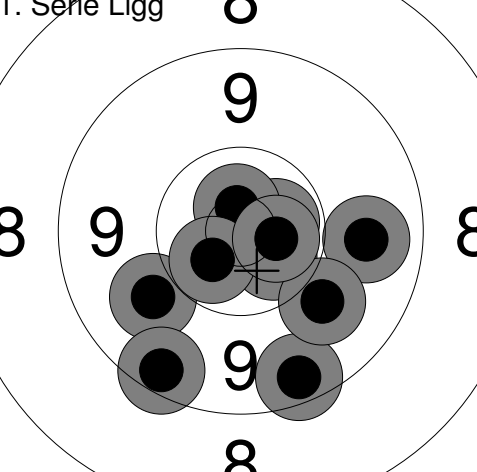
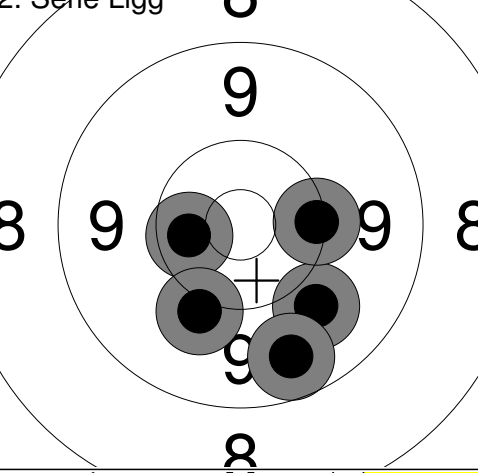
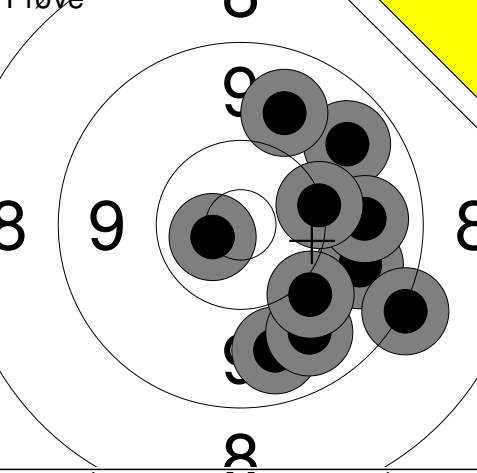
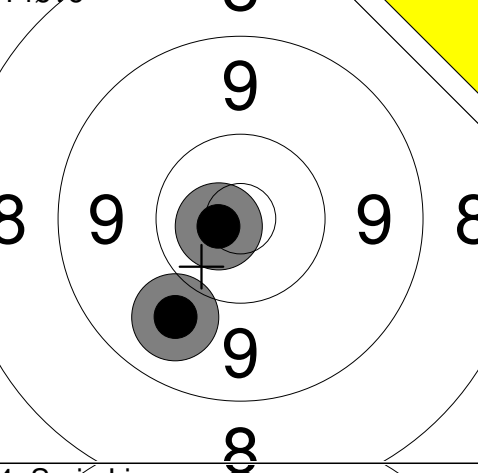
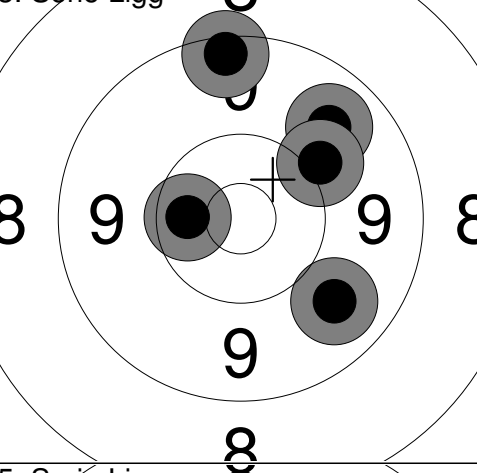
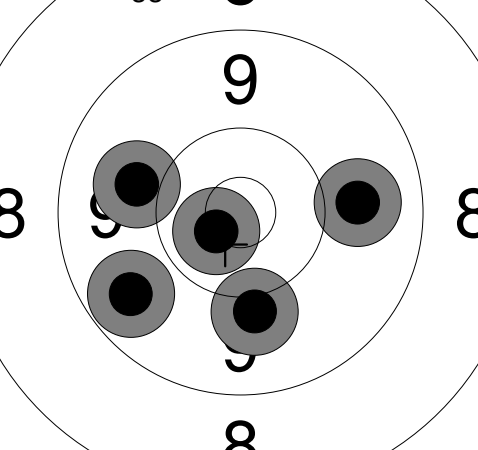
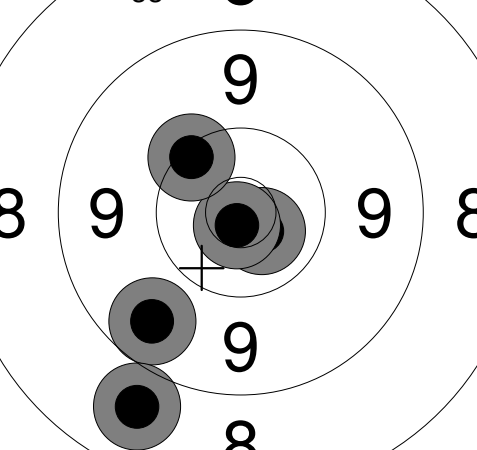
<b>Prøve</b> 	<table border="1" style="width:100%; border-collapse: collapse;"> <tr><td>1:</td><td>9.8</td><td>↗</td></tr> <tr><td>2:</td><td>10.2</td><td>↗</td></tr> <tr><td>3:</td><td>10.8x</td><td>↘</td></tr> <tr><td>4:</td><td>9.5</td><td>↘</td></tr> <tr><td>5:</td><td>10.2</td><td>↘</td></tr> <tr><td>6:</td><td>10.1</td><td>↘</td></tr> <tr><td>7:</td><td>10.7x</td><td>↘</td></tr> <tr><td>8:</td><td>10.5x</td><td>↘</td></tr> <tr><td>9:</td><td>9.6</td><td>↘</td></tr> <tr><td colspan="2"><b>Serie</b></td><td><b>87.0</b></td></tr> <tr><td colspan="2"><b>Total</b></td><td><b>0.0</b></td></tr> </table>	1:	9.8	↗	2:	10.2	↗	3:	10.8x	↘	4:	9.5	↘	5:	10.2	↘	6:	10.1	↘	7:	10.7x	↘	8:	10.5x	↘	9:	9.6	↘	<b>Serie</b>		<b>87.0</b>	<b>Total</b>		<b>0.0</b>	<b>1. Serie Ligg</b>  <table border="1" style="width:100%; border-collapse: collapse;"> <tr><td>1:</td><td>9.9</td><td>↙</td></tr> <tr><td>2:</td><td>9.8</td><td>→</td></tr> <tr><td>3:</td><td>10.6x</td><td>→</td></tr> <tr><td>4:</td><td>10.7x</td><td>↑</td></tr> <tr><td>5:</td><td>9.4</td><td>↘</td></tr> <tr><td>6:</td><td>10.6x</td><td>↘</td></tr> <tr><td>7:</td><td>9.4</td><td>↘</td></tr> <tr><td>8:</td><td>10.6x</td><td>↘</td></tr> <tr><td>9:</td><td>9.9</td><td>↘</td></tr> <tr><td>10:</td><td>10.6x</td><td>→</td></tr> <tr><td colspan="2"><b>Serie</b></td><td><b>95.0</b></td></tr> <tr><td colspan="2"><b>Total</b></td><td><b>95.0</b></td></tr> </table>	1:	9.9	↙	2:	9.8	→	3:	10.6x	→	4:	10.7x	↑	5:	9.4	↘	6:	10.6x	↘	7:	9.4	↘	8:	10.6x	↘	9:	9.9	↘	10:	10.6x	→	<b>Serie</b>		<b>95.0</b>	<b>Total</b>		<b>95.0</b>
1:	9.8	↗																																																																					
2:	10.2	↗																																																																					
3:	10.8x	↘																																																																					
4:	9.5	↘																																																																					
5:	10.2	↘																																																																					
6:	10.1	↘																																																																					
7:	10.7x	↘																																																																					
8:	10.5x	↘																																																																					
9:	9.6	↘																																																																					
<b>Serie</b>		<b>87.0</b>																																																																					
<b>Total</b>		<b>0.0</b>																																																																					
1:	9.9	↙																																																																					
2:	9.8	→																																																																					
3:	10.6x	→																																																																					
4:	10.7x	↑																																																																					
5:	9.4	↘																																																																					
6:	10.6x	↘																																																																					
7:	9.4	↘																																																																					
8:	10.6x	↘																																																																					
9:	9.9	↘																																																																					
10:	10.6x	→																																																																					
<b>Serie</b>		<b>95.0</b>																																																																					
<b>Total</b>		<b>95.0</b>																																																																					
<b>2. Serie Ligg</b>  <table border="1" style="width:100%; border-collapse: collapse;"> <tr><td>1:</td><td>10.5x</td><td>←</td></tr> <tr><td>2:</td><td>9.9</td><td>↘</td></tr> <tr><td>3:</td><td>10.2</td><td>→</td></tr> <tr><td>4:</td><td>9.6</td><td>↘</td></tr> <tr><td>5:</td><td>10.1</td><td>↘</td></tr> <tr><td colspan="2"><b>Serie</b></td><td><b>48.0</b></td></tr> <tr><td colspan="2"><b>Total</b></td><td><b>143.0</b></td></tr> </table>	1:	10.5x	←	2:	9.9	↘	3:	10.2	→	4:	9.6	↘	5:	10.1	↘	<b>Serie</b>		<b>48.0</b>	<b>Total</b>		<b>143.0</b>	<b>Prøve</b>  <table border="1" style="width:100%; border-collapse: collapse;"> <tr><td>1:</td><td>9.7</td><td>↗</td></tr> <tr><td>2:</td><td>10.7x</td><td>←</td></tr> <tr><td>3:</td><td>9.8</td><td>↑</td></tr> <tr><td>4:</td><td>9.8</td><td>→</td></tr> <tr><td>5:</td><td>9.1</td><td>↘</td></tr> <tr><td>6:</td><td>9.8</td><td>→</td></tr> <tr><td>7:</td><td>9.7</td><td>↘</td></tr> <tr><td>8:</td><td>9.7</td><td>↘</td></tr> <tr><td>9:</td><td>10.2</td><td>→</td></tr> <tr><td>10:</td><td>10.0</td><td>↘</td></tr> <tr><td colspan="2"><b>Serie</b></td><td><b>93.0</b></td></tr> <tr><td colspan="2"><b>Total</b></td><td><b>143.0</b></td></tr> </table>	1:	9.7	↗	2:	10.7x	←	3:	9.8	↑	4:	9.8	→	5:	9.1	↘	6:	9.8	→	7:	9.7	↘	8:	9.7	↘	9:	10.2	→	10:	10.0	↘	<b>Serie</b>		<b>93.0</b>	<b>Total</b>		<b>143.0</b>													
1:	10.5x	←																																																																					
2:	9.9	↘																																																																					
3:	10.2	→																																																																					
4:	9.6	↘																																																																					
5:	10.1	↘																																																																					
<b>Serie</b>		<b>48.0</b>																																																																					
<b>Total</b>		<b>143.0</b>																																																																					
1:	9.7	↗																																																																					
2:	10.7x	←																																																																					
3:	9.8	↑																																																																					
4:	9.8	→																																																																					
5:	9.1	↘																																																																					
6:	9.8	→																																																																					
7:	9.7	↘																																																																					
8:	9.7	↘																																																																					
9:	10.2	→																																																																					
10:	10.0	↘																																																																					
<b>Serie</b>		<b>93.0</b>																																																																					
<b>Total</b>		<b>143.0</b>																																																																					
<b>Prøve</b>  <table border="1" style="width:100%; border-collapse: collapse;"> <tr><td>11:</td><td>9.8</td><td>↘</td></tr> <tr><td>12:</td><td>10.7x</td><td>←</td></tr> <tr><td colspan="2"><b>Serie</b></td><td><b>19.0</b></td></tr> <tr><td colspan="2"><b>Total</b></td><td><b>143.0</b></td></tr> </table>	11:	9.8	↘	12:	10.7x	←	<b>Serie</b>		<b>19.0</b>	<b>Total</b>		<b>143.0</b>	<b>3. Serie Ligg</b>  <table border="1" style="width:100%; border-collapse: collapse;"> <tr><td>1:</td><td>9.7</td><td>↗</td></tr> <tr><td>2:</td><td>9.8</td><td>↘</td></tr> <tr><td>3:</td><td>9.4</td><td>↑</td></tr> <tr><td>4:</td><td>10.5x</td><td>←</td></tr> <tr><td>5:</td><td>10.0</td><td>↗</td></tr> <tr><td colspan="2"><b>Serie</b></td><td><b>47.0</b></td></tr> <tr><td colspan="2"><b>Total</b></td><td><b>190.0</b></td></tr> </table>	1:	9.7	↗	2:	9.8	↘	3:	9.4	↑	4:	10.5x	←	5:	10.0	↗	<b>Serie</b>		<b>47.0</b>	<b>Total</b>		<b>190.0</b>																																					
11:	9.8	↘																																																																					
12:	10.7x	←																																																																					
<b>Serie</b>		<b>19.0</b>																																																																					
<b>Total</b>		<b>143.0</b>																																																																					
1:	9.7	↗																																																																					
2:	9.8	↘																																																																					
3:	9.4	↑																																																																					
4:	10.5x	←																																																																					
5:	10.0	↗																																																																					
<b>Serie</b>		<b>47.0</b>																																																																					
<b>Total</b>		<b>190.0</b>																																																																					
<b>4. Serie Ligg</b>  <table border="1" style="width:100%; border-collapse: collapse;"> <tr><td>1:</td><td>9.8</td><td>→</td></tr> <tr><td>2:</td><td>10.0</td><td>↘</td></tr> <tr><td>3:</td><td>10.7x</td><td>↘</td></tr> <tr><td>4:</td><td>9.9</td><td>↘</td></tr> <tr><td>5:</td><td>9.6</td><td>↘</td></tr> <tr><td colspan="2"><b>Serie</b></td><td><b>47.0</b></td></tr> <tr><td colspan="2"><b>Total</b></td><td><b>237.0</b></td></tr> </table>	1:	9.8	→	2:	10.0	↘	3:	10.7x	↘	4:	9.9	↘	5:	9.6	↘	<b>Serie</b>		<b>47.0</b>	<b>Total</b>		<b>237.0</b>	<b>5. Serie Ligg</b>  <table border="1" style="width:100%; border-collapse: collapse;"> <tr><td>1:</td><td>9.6</td><td>↘</td></tr> <tr><td>2:</td><td>8.8</td><td>↘</td></tr> <tr><td>3:</td><td>10.7x</td><td>↘</td></tr> <tr><td>4:</td><td>10.8x</td><td>↘</td></tr> <tr><td>5:</td><td>10.3</td><td>↗</td></tr> <tr><td colspan="2"><b>Serie</b></td><td><b>47.0</b></td></tr> <tr><td colspan="2"><b>Total</b></td><td><b>284.0</b></td></tr> </table>	1:	9.6	↘	2:	8.8	↘	3:	10.7x	↘	4:	10.8x	↘	5:	10.3	↗	<b>Serie</b>		<b>47.0</b>	<b>Total</b>		<b>284.0</b>																												
1:	9.8	→																																																																					
2:	10.0	↘																																																																					
3:	10.7x	↘																																																																					
4:	9.9	↘																																																																					
5:	9.6	↘																																																																					
<b>Serie</b>		<b>47.0</b>																																																																					
<b>Total</b>		<b>237.0</b>																																																																					
1:	9.6	↘																																																																					
2:	8.8	↘																																																																					
3:	10.7x	↘																																																																					
4:	10.8x	↘																																																																					
5:	10.3	↗																																																																					
<b>Serie</b>		<b>47.0</b>																																																																					
<b>Total</b>		<b>284.0</b>																																																																					



<p>Prøve</p>	<table border="1" style="width:100%; border-collapse: collapse;"> <tr><td>1:</td><td>3.5</td><td>↗</td></tr> <tr><td>2:</td><td>10.0</td><td>←</td></tr> <tr><td>3:</td><td>10.0</td><td>↗</td></tr> <tr><td>4:</td><td>9.9</td><td>↗</td></tr> <tr><td>5:</td><td>9.6</td><td>↗</td></tr> <tr><td>6:</td><td>10.3</td><td>↘</td></tr> <tr><td>7:</td><td>10.2</td><td>↘</td></tr> <tr><td>8:</td><td>10.8x</td><td>↘</td></tr> <tr><td>9:</td><td>9.9</td><td>↗</td></tr> <tr><td>10:</td><td>10.3</td><td>←</td></tr> <tr><td colspan="2">Serie</td><td>90.0</td></tr> <tr><td colspan="2">Total</td><td>0.0</td></tr> </table>	1:	3.5	↗	2:	10.0	←	3:	10.0	↗	4:	9.9	↗	5:	9.6	↗	6:	10.3	↘	7:	10.2	↘	8:	10.8x	↘	9:	9.9	↗	10:	10.3	←	Serie		90.0	Total		0.0	<p>1. Serie Ligg</p> <table border="1" style="width:100%; border-collapse: collapse;"> <tr><td>1:</td><td>10.0</td><td>↗</td></tr> <tr><td>2:</td><td>10.5x</td><td>←</td></tr> <tr><td>3:</td><td>10.7x</td><td>←</td></tr> <tr><td>4:</td><td>9.9</td><td>↗</td></tr> <tr><td>5:</td><td>10.4</td><td>↑</td></tr> <tr><td>6:</td><td>10.6x</td><td>↗</td></tr> <tr><td>7:</td><td>9.8</td><td>←</td></tr> <tr><td>8:</td><td>10.8x</td><td>↗</td></tr> <tr><td>9:</td><td>10.8x</td><td>←</td></tr> <tr><td>10:</td><td>10.7x</td><td>↘</td></tr> <tr><td colspan="2">Serie</td><td>98.0</td></tr> <tr><td colspan="2">Total</td><td>98.0</td></tr> </table>	1:	10.0	↗	2:	10.5x	←	3:	10.7x	←	4:	9.9	↗	5:	10.4	↑	6:	10.6x	↗	7:	9.8	←	8:	10.8x	↗	9:	10.8x	←	10:	10.7x	↘	Serie		98.0	Total		98.0
1:	3.5	↗																																																																								
2:	10.0	←																																																																								
3:	10.0	↗																																																																								
4:	9.9	↗																																																																								
5:	9.6	↗																																																																								
6:	10.3	↘																																																																								
7:	10.2	↘																																																																								
8:	10.8x	↘																																																																								
9:	9.9	↗																																																																								
10:	10.3	←																																																																								
Serie		90.0																																																																								
Total		0.0																																																																								
1:	10.0	↗																																																																								
2:	10.5x	←																																																																								
3:	10.7x	←																																																																								
4:	9.9	↗																																																																								
5:	10.4	↑																																																																								
6:	10.6x	↗																																																																								
7:	9.8	←																																																																								
8:	10.8x	↗																																																																								
9:	10.8x	←																																																																								
10:	10.7x	↘																																																																								
Serie		98.0																																																																								
Total		98.0																																																																								

<p>2. Serie Ligg</p> <table border="1" style="width:100%; border-collapse: collapse;"> <tr><td>1:</td><td>10.4</td><td>↓</td></tr> <tr><td>2:</td><td>10.1</td><td>←</td></tr> <tr><td>3:</td><td>10.6x</td><td>↗</td></tr> <tr><td>4:</td><td>10.5x</td><td>↗</td></tr> <tr><td>5:</td><td>9.2</td><td>←</td></tr> <tr><td colspan="2">Serie</td><td>49.0</td></tr> <tr><td colspan="2">Total</td><td>147.0</td></tr> </table>	1:	10.4	↓	2:	10.1	←	3:	10.6x	↗	4:	10.5x	↗	5:	9.2	←	Serie		49.0	Total		147.0	<p>Prøve</p> <table border="1" style="width:100%; border-collapse: collapse;"> <tr><td>1:</td><td>10.3</td><td>↓</td></tr> <tr><td>2:</td><td>10.5x</td><td>↗</td></tr> <tr><td>3:</td><td>10.3</td><td>→</td></tr> <tr><td>4:</td><td>10.6x</td><td>↗</td></tr> <tr><td>5:</td><td>10.7x</td><td>→</td></tr> <tr><td colspan="2">Serie</td><td>50.0</td></tr> <tr><td colspan="2">Total</td><td>147.0</td></tr> </table>	1:	10.3	↓	2:	10.5x	↗	3:	10.3	→	4:	10.6x	↗	5:	10.7x	→	Serie		50.0	Total		147.0
1:	10.4	↓																																									
2:	10.1	←																																									
3:	10.6x	↗																																									
4:	10.5x	↗																																									
5:	9.2	←																																									
Serie		49.0																																									
Total		147.0																																									
1:	10.3	↓																																									
2:	10.5x	↗																																									
3:	10.3	→																																									
4:	10.6x	↗																																									
5:	10.7x	→																																									
Serie		50.0																																									
Total		147.0																																									

<p>3. Serie Ligg</p> <table border="1" style="width:100%; border-collapse: collapse;"> <tr><td>1:</td><td>10.3</td><td>←</td></tr> <tr><td>2:</td><td>10.7x</td><td>←</td></tr> <tr><td>3:</td><td>10.8x</td><td>↘</td></tr> <tr><td>4:</td><td>10.5x</td><td>↗</td></tr> <tr><td>5:</td><td>9.9</td><td>↘</td></tr> <tr><td colspan="2">Serie</td><td>49.0</td></tr> <tr><td colspan="2">Total</td><td>196.0</td></tr> </table>	1:	10.3	←	2:	10.7x	←	3:	10.8x	↘	4:	10.5x	↗	5:	9.9	↘	Serie		49.0	Total		196.0	<p>4. Serie Ligg</p> <table border="1" style="width:100%; border-collapse: collapse;"> <tr><td>1:</td><td>10.3</td><td>←</td></tr> <tr><td>2:</td><td>9.7</td><td>↘</td></tr> <tr><td>3:</td><td>10.3</td><td>↘</td></tr> <tr><td>4:</td><td>9.9</td><td>→</td></tr> <tr><td>5:</td><td>9.8</td><td>↑</td></tr> <tr><td colspan="2">Serie</td><td>47.0</td></tr> <tr><td colspan="2">Total</td><td>243.0</td></tr> </table>	1:	10.3	←	2:	9.7	↘	3:	10.3	↘	4:	9.9	→	5:	9.8	↑	Serie		47.0	Total		243.0
1:	10.3	←																																									
2:	10.7x	←																																									
3:	10.8x	↘																																									
4:	10.5x	↗																																									
5:	9.9	↘																																									
Serie		49.0																																									
Total		196.0																																									
1:	10.3	←																																									
2:	9.7	↘																																									
3:	10.3	↘																																									
4:	9.9	→																																									
5:	9.8	↑																																									
Serie		47.0																																									
Total		243.0																																									

<p>5. Serie Ligg</p> <table border="1" style="width:100%; border-collapse: collapse;"> <tr><td>1:</td><td>10.1</td><td>↘</td></tr> <tr><td>2:</td><td>10.8x</td><td>↘</td></tr> <tr><td>3:</td><td>10.0</td><td>↗</td></tr> <tr><td>4:</td><td>10.0</td><td>↗</td></tr> <tr><td>5:</td><td>10.6x</td><td>←</td></tr> <tr><td colspan="2">Serie</td><td>50.0</td></tr> <tr><td colspan="2">Total</td><td>293.0</td></tr> </table>	1:	10.1	↘	2:	10.8x	↘	3:	10.0	↗	4:	10.0	↗	5:	10.6x	←	Serie		50.0	Total		293.0	
1:	10.1	↘																				
2:	10.8x	↘																				
3:	10.0	↗																				
4:	10.0	↗																				
5:	10.6x	←																				
Serie		50.0																				
Total		293.0																				

Hold	Skive	Gitte Larsen	
557	20		
50 meter afsnit 2		Østmøn SG&I	LIG
Landsstævne 2017		Aalborg Skyttekreds	
Prøve		1: 8.9 ↘ 2: 9.7 ↘ 3: 9.5 → 4: 9.9 ↘ 5: 10.3 ↑ 6: 10.0 ↘ 7: 9.6 → 8: 10.4 ↘ 9: 10.2 → 10: 9.9 ↘ Serie 93.0 Total 0.0	Prøve 11: 9.2 ↓ 12: 10.2 ↓ Serie 19.0 Total 0.0
1. Serie Ligg		1: 9.3 ↑ 2: 9.7 ↘ 3: 10.3 ↘ 4: 9.1 ↑ 5: 8.9 ↑ 6: 10.3 → 7: 10.5x ↘ 8: 9.3 ↘ 9: 10.6x ↘ 10: 10.3 ↘ Serie 94.0 Total 94.0	2. Serie Ligg 1: 9.7 ↘ 2: 9.7 ↘ 3: 10.4 ↘ 4: 9.2 ↘ 5: 9.9 ↘ Serie 46.0 Total 140.0
Prøve		1: 10.3 ↘ 2: 10.3 ↑ 3: 10.7x ↘ 4: 10.2 ↘ 5: 10.8x → 6: 10.3 ↘ 7: 10.3 ↘ Serie 70.0 Total 140.0	3. Serie Ligg 1: 8.6 ↘ 2: 9.2 ↘ 3: 10.8x ↑ 4: 10.1 ↘ 5: 9.6 → Serie 46.0 Total 186.0
4. Serie Ligg		1: 10.2 → 2: 10.7x ↘ 3: 10.1 → 4: 10.0 → 5: 10.7x ↘ Serie 50.0 Total 236.0	5. Serie Ligg 1: 10.1 ↘ 2: 9.8 ↘ 3: 10.4 → 4: 10.6x → 5: 10.3 ↑ Serie 49.0 Total 285.0

Hold	Skive	Anders Hansen	
558	13	Aalborg Skyttekreds	
50 meter afsnit 2		LIG	
Landsstævne 2017		Aalborg Skyttekreds	
Prøve		1: 10.7x ↘ 2: 10.9x ↗ 3: 10.9x ↗ 4: 10.7x ↗	1. Serie Ligg
			1: 10.4x ↘ 2: 10.5x ↘ 3: 10.3 ↘ 4: 10.6x ↘ 5: 10.2 → 6: 10.2 ↗ 7: 10.3 → 8: 10.4 ← 9: 10.2 ↘ 10: 10.8x ↘
	Serie 40.0 Total 0.0		Serie 100.0 Total 100.0
2. Serie Ligg		1: 10.4x → 2: 10.2 → 3: 10.4 ↘ 4: 10.4 ↘ 5: 10.3 ↘	Prøve
			1: 9.7 ← 2: 10.7x → 3: 9.9 → 4: 10.1 ↘ 5: 10.5x ↑ 6: 10.7x ↗
	Serie 50.0 Total 150.0		Serie 58.0 Total 150.0
3. Serie Ligg		1: 10.5x ← 2: 10.6x ↑ 3: 10.5x ↑ 4: 10.7x → 5: 10.0 ←	4. Serie Ligg
			1: 10.2 ↘ 2: 10.7x ↘ 3: 10.4x ← 4: 10.7x ↘ 5: 10.5x ←
	Serie 50.0 Total 200.0		Serie 50.0 Total 250.0
5. Serie Ligg		1: 10.2 → 2: 10.4 ↗ 3: 10.7x ↗ 4: 10.4 ↘ 5: 10.3 ↘	
	Serie 50.0 Total 300.0		

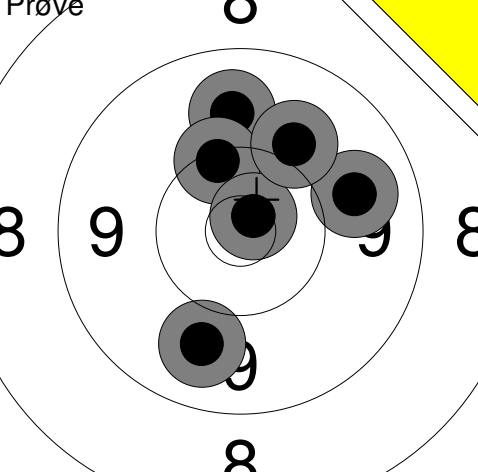
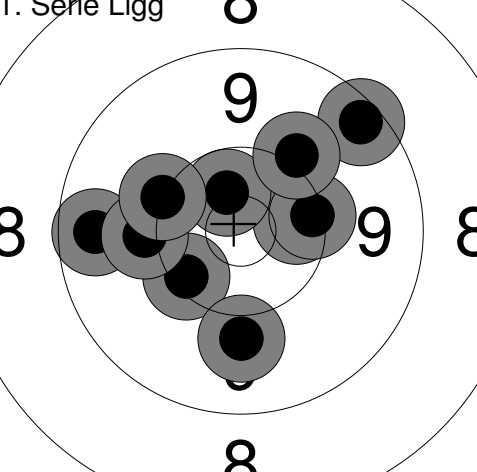
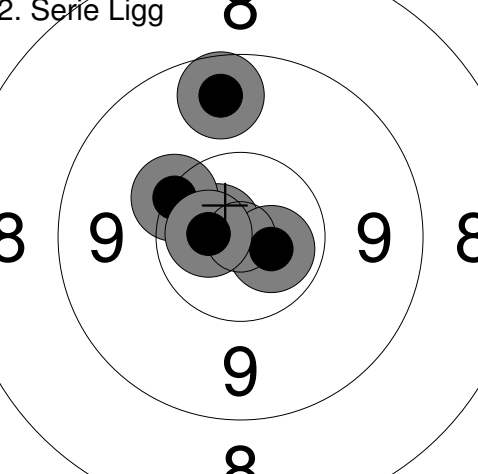
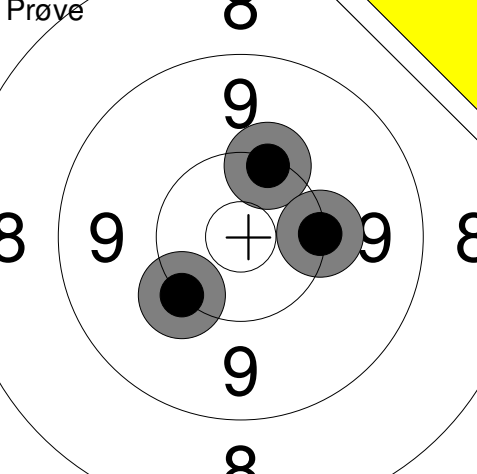
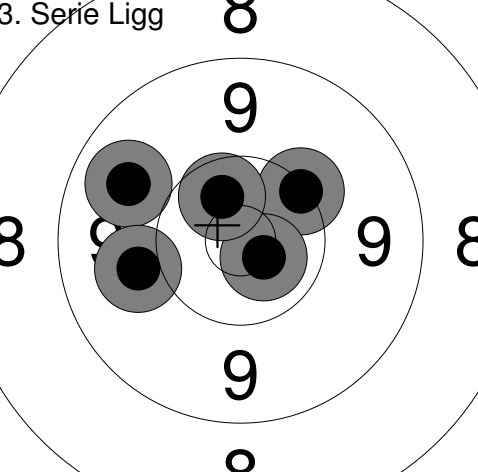
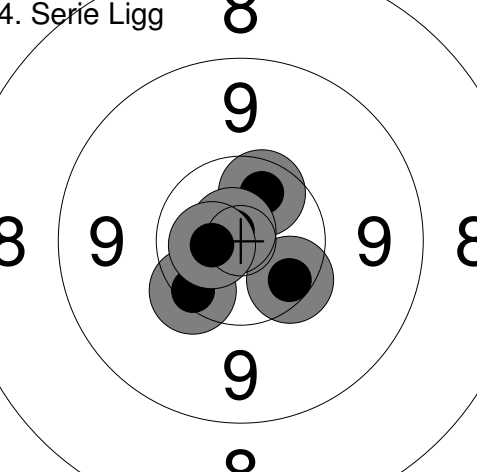
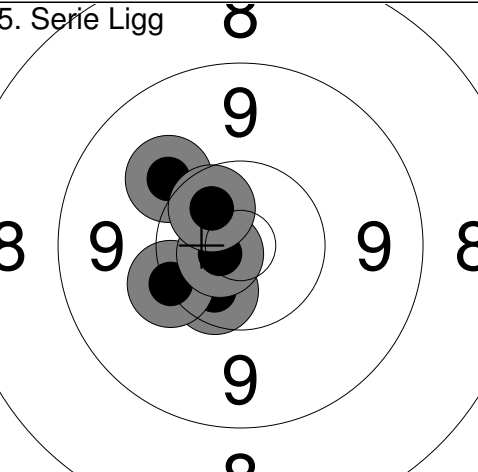
Prøve 	1: 9.8 → 2: 9.8 ↑ 3: 10.3 ↑ 4: 9.8 ↓ 5: 10.8x ↗ 6: 10.0 ↗	1. Serie Ligg 	1: 9.4 ↗ 2: 10.3 ↘ 3: 9.6 ← 4: 10.4x → 5: 10.6x ↑ 6: 9.9 ↓ 7: 10.0 ← 8: 10.2 ↖ 9: 10.3 → 10: 10.1 ↗
Serie 57.0	Total 0.0	Serie 97.0	Total 97.0
2. Serie Ligg 	1: 10.7x ← 2: 10.6x ↘ 3: 10.2 ↗ 4: 9.6 ↑ 5: 10.6x ←	Prøve 	1: 10.2 ↘ 2: 10.2 ↑ 3: 10.2 →
Serie 49.0	Total 146.0	Serie 30.0	Total 146.0
3. Serie Ligg 	1: 9.8 ↖ 2: 10.0 ← 3: 10.2 ↗ 4: 10.7x ↘ 5: 10.5x ↗	4. Serie Ligg 	1: 10.4 ↘ 2: 10.5x ↑ 3: 10.3 ↘ 4: 10.8x ↗ 5: 10.7x ←
Serie 49.0	Total 195.0	Serie 50.0	Total 245.0
5. Serie Ligg 	1: 10.0 ↗ 2: 10.5x ↓ 3: 10.2 ↖ 4: 10.7x ← 5: 10.5x ↗		
Serie 50.0	Total 295.0		

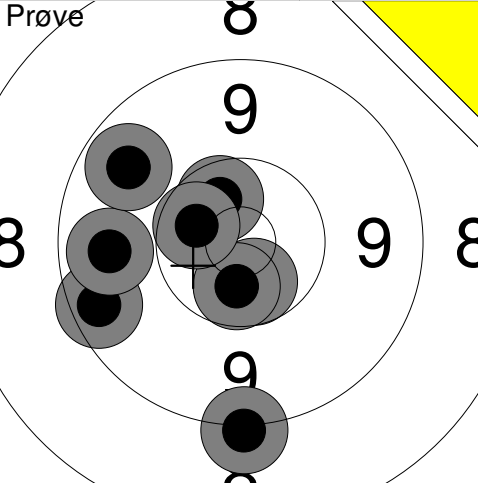
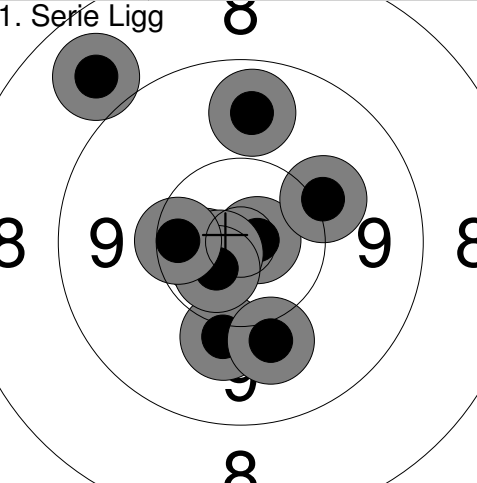
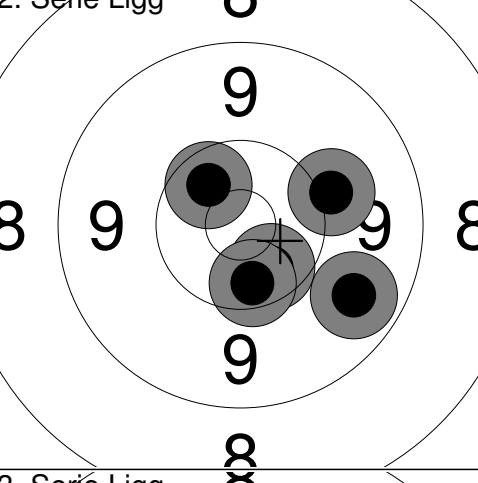
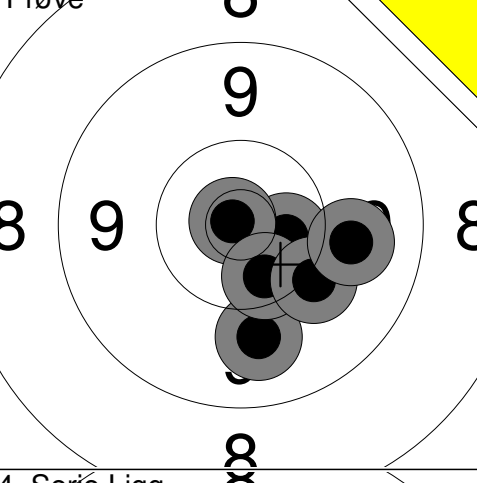
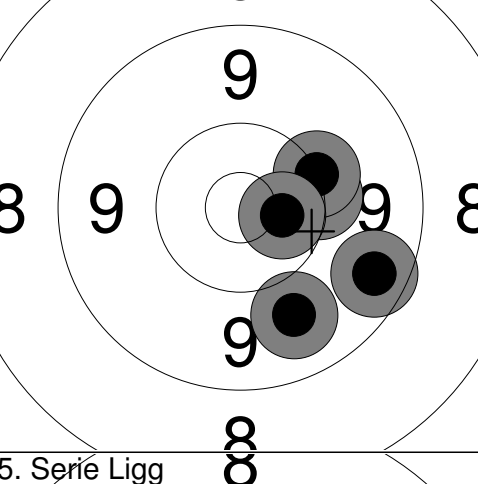
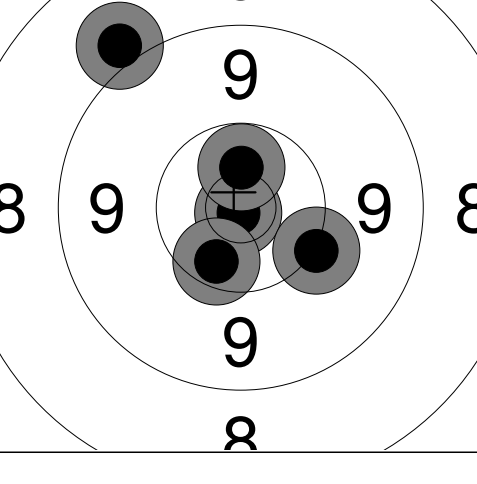
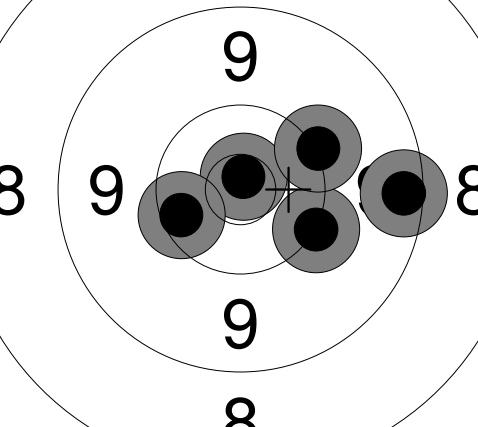
Hold	Skive	Nicklas Christensen	
558	16		
50 meter afsnit 2		Aalborg Skyttekreds	
		LIG	
		Landsstævne 2017	
		Aalborg Skyttekreds	
Prøve		1: 10.6x ↘ 2: 9.5 ← 3: 9.7 ← 4: 9.1 ↘ 5: 10.5x ↘ 6: 10.5x ↗ 7: 10.5x ↗ 8: 9.7 ↗	1. Serie Ligg
		Serie 76.0 Total 0.0	
			1: 8.8 ↗ 2: 10.8x → 3: 10.0 ↘ 4: 10.6x ← 5: 9.7 ↑ 6: 10.1 ↗ 7: 10.7x ← 8: 10.6x ↘ 9: 10.0 ↘ 10: 10.4 ← Serie 97.0 Total 97.0
2. Serie Ligg		1: 10.5x ↗ 2: 10.5x ↘ 3: 10.0 → 4: 9.7 ↘ 5: 10.4 ↘	Prøve
		Serie 49.0 Total 146.0	
			1: 9.9 ↘ 2: 10.5x → 3: 10.9x ↗ 4: 10.4x ↘ 5: 10.1 ↘ 6: 9.9 → Serie 58.0 Total 146.0
3. Serie Ligg		1: 9.8 ↘ 2: 10.2 → 3: 10.2 → 4: 10.6x → 5: 9.5 ↘	4. Serie Ligg
		Serie 48.0 Total 194.0	
			1: 10.9x ↘ 2: 9.0 ↗ 3: 10.6x ↑ 4: 10.1 ↘ 5: 10.4 ↘ Serie 49.0 Total 243.0
5. Serie Ligg		1: 10.8x ↑ 2: 10.3 ← 3: 10.1 ↘ 4: 9.4 → 5: 10.1 ↗	
		Serie 49.0 Total 292.0	

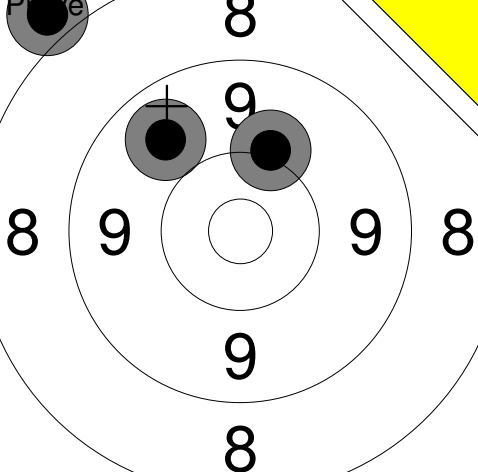
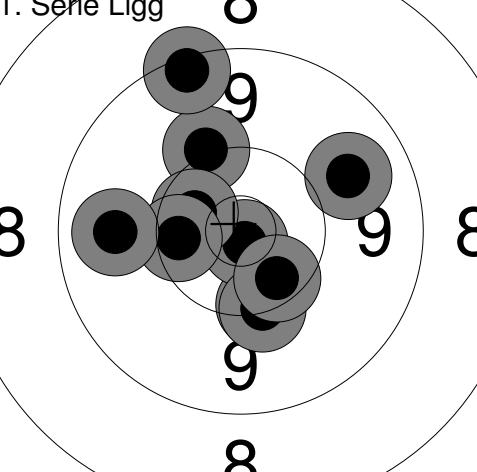
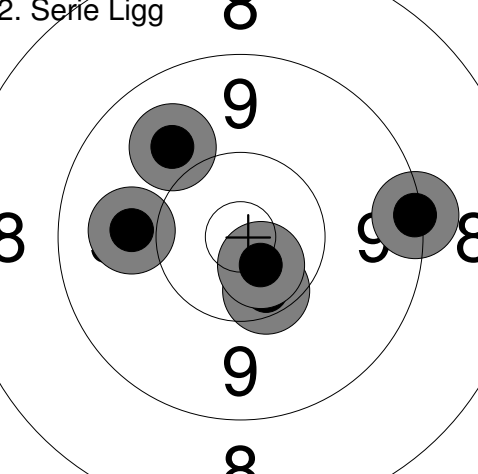
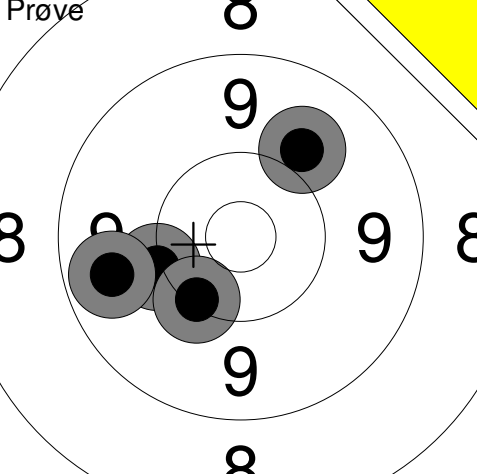
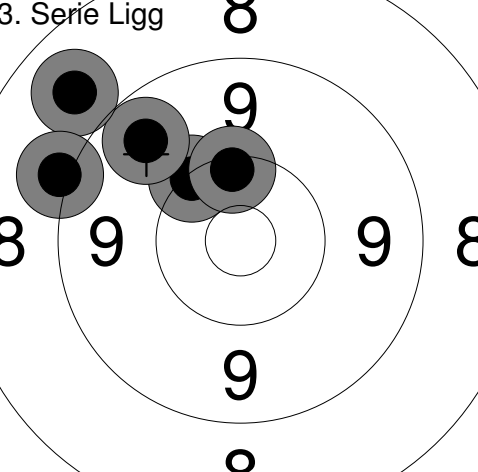
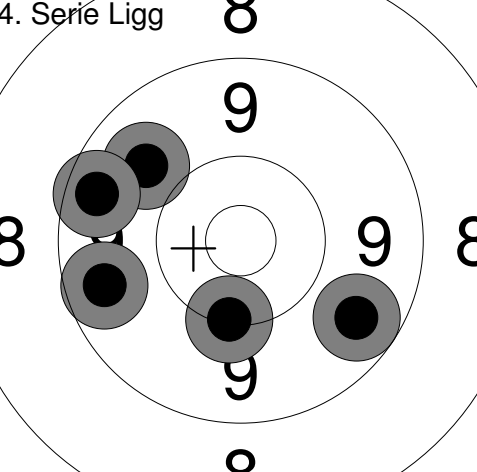
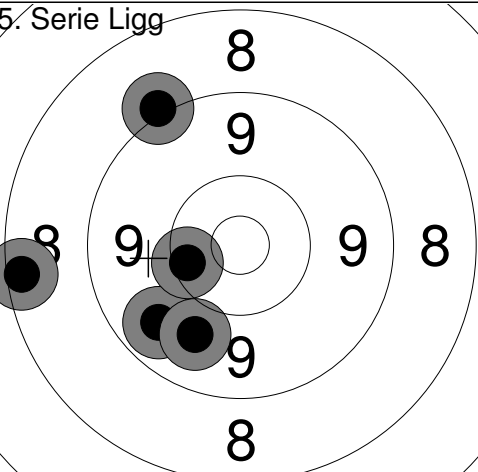
 <p style="text-align: center;">1. Serie Ligg</p>	<table border="1" style="width:100%; border-collapse: collapse;"> <tr><td>1:</td><td>10.1</td><td>↗</td></tr> <tr><td>2:</td><td>7.9</td><td>↗</td></tr> <tr><td>3:</td><td>9.7</td><td>↗</td></tr> <tr><td colspan="3">Serie 26.0</td></tr> <tr><td colspan="3">Total 0.0</td></tr> </table>	1:	10.1	↗	2:	7.9	↗	3:	9.7	↗	Serie 26.0			Total 0.0			 <p style="text-align: center;">1. Serie Ligg</p>	<table border="1" style="width:100%; border-collapse: collapse;"> <tr><td>1:</td><td>10.2</td><td>↓</td></tr> <tr><td>2:</td><td>10.8x</td><td>↓</td></tr> <tr><td>3:</td><td>10.2</td><td>↓</td></tr> <tr><td>4:</td><td>10.1</td><td>↗</td></tr> <tr><td>5:</td><td>9.3</td><td>↗</td></tr> <tr><td>6:</td><td>10.5x</td><td>↖</td></tr> <tr><td>7:</td><td>10.4</td><td>↓</td></tr> <tr><td>8:</td><td>9.8</td><td>↗</td></tr> <tr><td>9:</td><td>10.4</td><td>←</td></tr> <tr><td>10:</td><td>9.8</td><td>←</td></tr> <tr><td colspan="3">Serie 97.0</td></tr> <tr><td colspan="3">Total 97.0</td></tr> </table>	1:	10.2	↓	2:	10.8x	↓	3:	10.2	↓	4:	10.1	↗	5:	9.3	↗	6:	10.5x	↖	7:	10.4	↓	8:	9.8	↗	9:	10.4	←	10:	9.8	←	Serie 97.0			Total 97.0		
1:	10.1	↗																																																				
2:	7.9	↗																																																				
3:	9.7	↗																																																				
Serie 26.0																																																						
Total 0.0																																																						
1:	10.2	↓																																																				
2:	10.8x	↓																																																				
3:	10.2	↓																																																				
4:	10.1	↗																																																				
5:	9.3	↗																																																				
6:	10.5x	↖																																																				
7:	10.4	↓																																																				
8:	9.8	↗																																																				
9:	10.4	←																																																				
10:	9.8	←																																																				
Serie 97.0																																																						
Total 97.0																																																						
 <p style="text-align: center;">2. Serie Ligg</p>	<table border="1" style="width:100%; border-collapse: collapse;"> <tr><td>1:</td><td>9.2</td><td>→</td></tr> <tr><td>2:</td><td>9.9</td><td>↖</td></tr> <tr><td>3:</td><td>10.4</td><td>↘</td></tr> <tr><td>4:</td><td>10.6x</td><td>↘</td></tr> <tr><td>5:</td><td>9.9</td><td>↗</td></tr> <tr><td colspan="3">Serie 47.0</td></tr> <tr><td colspan="3">Total 144.0</td></tr> </table>	1:	9.2	→	2:	9.9	↖	3:	10.4	↘	4:	10.6x	↘	5:	9.9	↗	Serie 47.0			Total 144.0			 <p style="text-align: center;">Prøve</p>	<table border="1" style="width:100%; border-collapse: collapse;"> <tr><td>1:</td><td>10.1</td><td>←</td></tr> <tr><td>2:</td><td>10.2</td><td>↓</td></tr> <tr><td>3:</td><td>9.7</td><td>←</td></tr> <tr><td>4:</td><td>10.0</td><td>↗</td></tr> <tr><td colspan="3">Serie 39.0</td></tr> <tr><td colspan="3">Total 144.0</td></tr> </table>	1:	10.1	←	2:	10.2	↓	3:	9.7	←	4:	10.0	↗	Serie 39.0			Total 144.0														
1:	9.2	→																																																				
2:	9.9	↖																																																				
3:	10.4	↘																																																				
4:	10.6x	↘																																																				
5:	9.9	↗																																																				
Serie 47.0																																																						
Total 144.0																																																						
1:	10.1	←																																																				
2:	10.2	↓																																																				
3:	9.7	←																																																				
4:	10.0	↗																																																				
Serie 39.0																																																						
Total 144.0																																																						
 <p style="text-align: center;">3. Serie Ligg</p>	<table border="1" style="width:100%; border-collapse: collapse;"> <tr><td>1:</td><td>10.2</td><td>↗</td></tr> <tr><td>2:</td><td>9.6</td><td>↗</td></tr> <tr><td>3:</td><td>8.8</td><td>↗</td></tr> <tr><td>4:</td><td>9.1</td><td>↗</td></tr> <tr><td>5:</td><td>10.3</td><td>↗</td></tr> <tr><td colspan="3">Serie 46.0</td></tr> <tr><td colspan="3">Total 190.0</td></tr> </table>	1:	10.2	↗	2:	9.6	↗	3:	8.8	↗	4:	9.1	↗	5:	10.3	↗	Serie 46.0			Total 190.0			 <p style="text-align: center;">4. Serie Ligg</p>	<table border="1" style="width:100%; border-collapse: collapse;"> <tr><td>1:</td><td>9.8</td><td>↗</td></tr> <tr><td>2:</td><td>10.2</td><td>↓</td></tr> <tr><td>3:</td><td>9.6</td><td>←</td></tr> <tr><td>4:</td><td>9.6</td><td>↘</td></tr> <tr><td>5:</td><td>9.5</td><td>↖</td></tr> <tr><td colspan="3">Serie 46.0</td></tr> <tr><td colspan="3">Total 236.0</td></tr> </table>	1:	9.8	↗	2:	10.2	↓	3:	9.6	←	4:	9.6	↘	5:	9.5	↖	Serie 46.0			Total 236.0											
1:	10.2	↗																																																				
2:	9.6	↗																																																				
3:	8.8	↗																																																				
4:	9.1	↗																																																				
5:	10.3	↗																																																				
Serie 46.0																																																						
Total 190.0																																																						
1:	9.8	↗																																																				
2:	10.2	↓																																																				
3:	9.6	←																																																				
4:	9.6	↘																																																				
5:	9.5	↖																																																				
Serie 46.0																																																						
Total 236.0																																																						
 <p style="text-align: center;">5. Serie Ligg</p>	<table border="1" style="width:100%; border-collapse: collapse;"> <tr><td>1:</td><td>9.1</td><td>↗</td></tr> <tr><td>2:</td><td>8.4</td><td>←</td></tr> <tr><td>3:</td><td>9.7</td><td>↘</td></tr> <tr><td>4:</td><td>9.8</td><td>↘</td></tr> <tr><td>5:</td><td>10.3</td><td>←</td></tr> <tr><td colspan="3">Serie 45.0</td></tr> <tr><td colspan="3">Total 281.0</td></tr> </table>	1:	9.1	↗	2:	8.4	←	3:	9.7	↘	4:	9.8	↘	5:	10.3	←	Serie 45.0			Total 281.0																																		
1:	9.1	↗																																																				
2:	8.4	←																																																				
3:	9.7	↘																																																				
4:	9.8	↘																																																				
5:	10.3	←																																																				
Serie 45.0																																																						
Total 281.0																																																						

Hold	Skive	Uffe Pedersen			
558	20				
50 meter afsnit 2		Horne Skytteforening			
		LIG			
		Landsstævne 2017			
		Aalborg Skyttekreds			
Prøve		1: 7.5 → 2: 7.4 → 3: 10.3 ↗ 4: 10.1 → 5: 10.3 → 6: 9.8 ↗ 7: 10.1 ↗ 8: 10.1 ↗ 9: 10.4x ← 10: 10.5x ↓ Serie 93.0 Total 0.0	1. Serie Ligg		1: 10.2 ↑ 2: 10.3 ↖ 3: 10.0 ↓ 4: 10.8x ↗ 5: 10.4 ← 6: 10.6x ↖ 7: 10.1 ↓ 8: 10.2 ↓ 9: 10.7x ← 10: 9.8 ↖ Serie 99.0 Total 99.0
2. Serie Ligg		1: 10.3 ↖ 2: 10.2 ↓ 3: 10.0 ← 4: 10.6x ↓ 5: 9.5 ↓ Serie 49.0 Total 148.0	Prøve		1: 9.8 ↖ 2: 10.1 ↖ 3: 10.5x ↓ 4: 9.1 ↓ 5: 10.5x ← 6: 9.6 ↘ 7: 9.7 ↖ 8: 9.9 ← Serie 75.0 Total 148.0
3. Serie Ligg		1: 9.6 ↗ 2: 10.3 ↖ 3: 9.8 ← 4: 10.6x ↗ 5: 10.5x → Serie 48.0 Total 196.0	4. Serie Ligg		1: 10.3 ↓ 2: 10.8x ↘ 3: 10.2 ↗ 4: 10.3 ↖ 5: 10.2 ↓ Serie 50.0 Total 246.0
5. Serie Ligg		1: 10.0 ← 2: 10.5x ↗ 3: 9.8 ← 4: 10.1 ↖ 5: 10.4 ↗ Serie 49.0 Total 295.0			

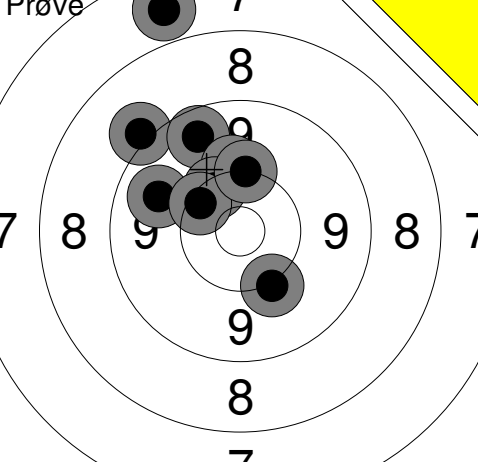
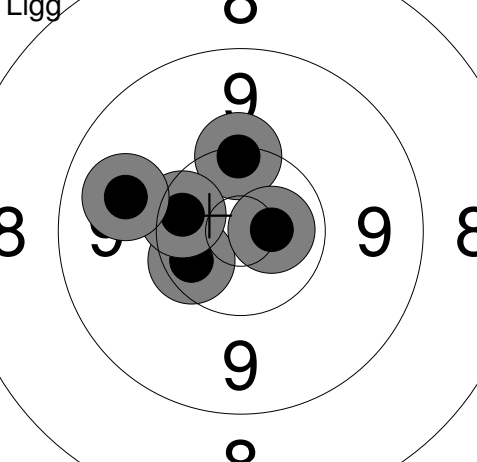
<b>Prøve</b> 	1: 7.7 ↗ 2: 9.1 ↗ 3: 9.6 ↗ 4: 9.8 ↗ 5: 10.1 ↗ 6: 10.3 ↗ 7: 10.3 ↗ 8: 10.1 ↘ 9: 10.2 ↗ <hr/> Serie 84.0 Total 0.0	<b>Ligg</b> 	1: 10.4 ↖ 2: 10.3 ↗ 3: 10.4 ↖ 4: 9.8 ↖ 5: 10.7x → <hr/> Serie 49.0 Total 49.0
--	--	---	---

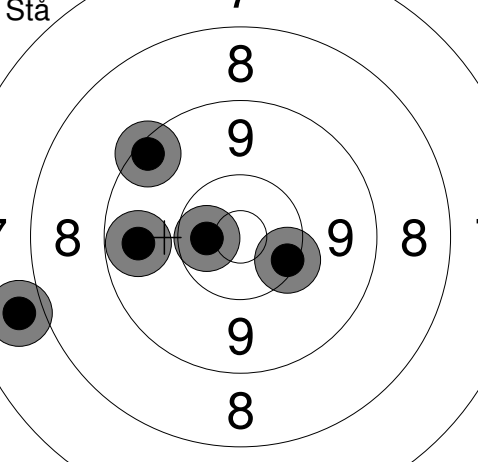
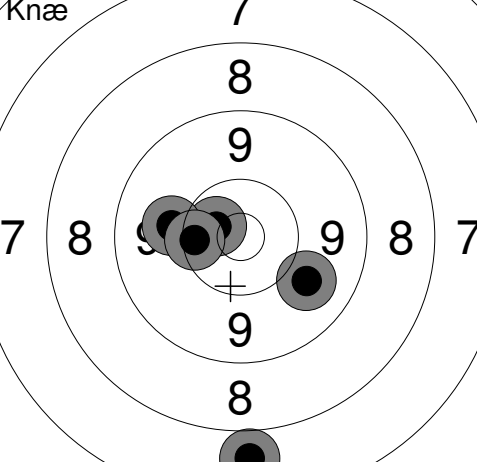
<b>Stå</b> 	1: 9.3 ↗ 2: 10.3 ↘ 3: 10.5x ← 4: 9.6 ← 5: 7.9 ← <hr/> Serie 45.0 Total 94.0	<b>Knæ</b> 	1: 10.6x ↖ 2: 10.0 ↖ 3: 10.3 ↖ 4: 9.9 ↘ 5: 7.8 ↓ <hr/> Serie 46.0 Total 140.0
---	---	---	---

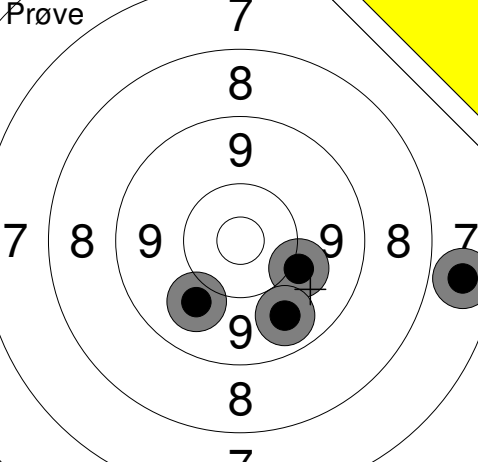
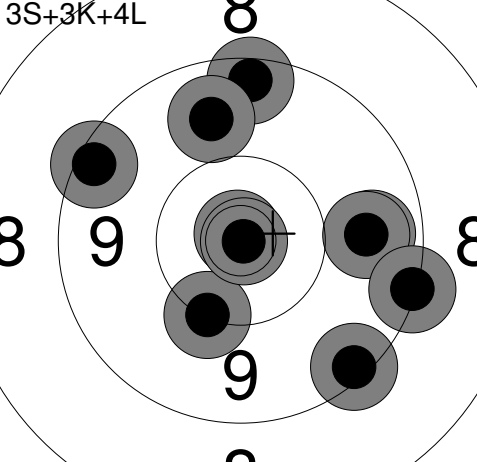
<b>Prøve</b> 	1: 10.1 ↘ 2: 9.9 ↘ 3: 7.7 ↘ 4: 9.7 ↘ <hr/> Serie 35.0 Total 140.0	<b>3S+3K+4L</b> 	1: 9.7 → 2: 9.4 ↗ 3: 9.8 ↗ 4: 9.8 → 5: 9.3 ↘ 6: 10.2 ↘ 7: 9.4 ↗ 8: 10.9x ↗ 9: 9.2 → 10: 10.9x → <hr/> Serie 93.0 Total 233.0
--	--	---	---

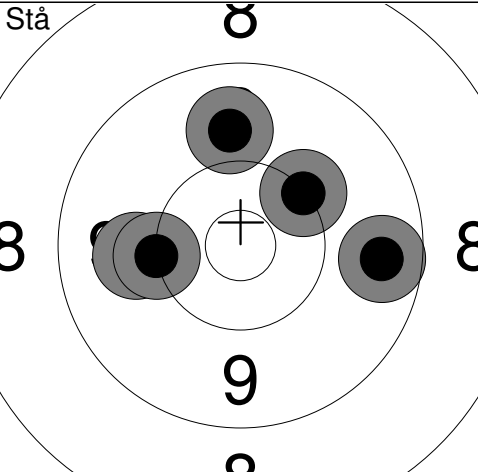
<b>Stå</b> 	1: 10.0 ← 2: 9.6 → 3: 10.2 ← 4: 9.9 ↗ 5: 10.2 ↗ <hr/> Serie 48.0 Total 281.0		
--	--	--	--

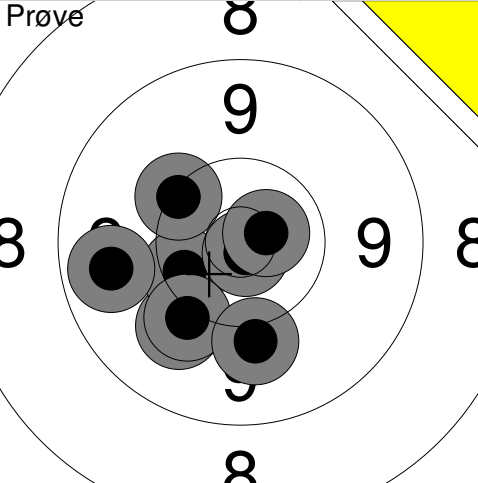
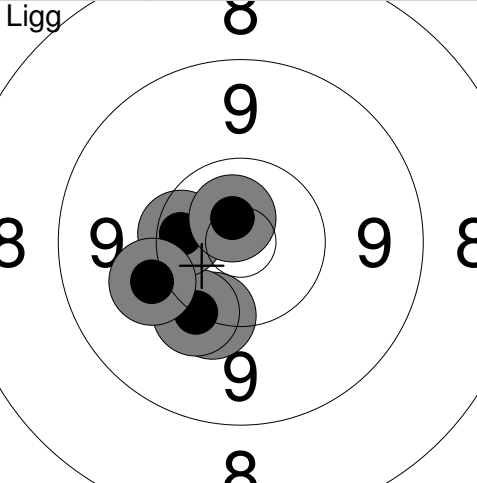
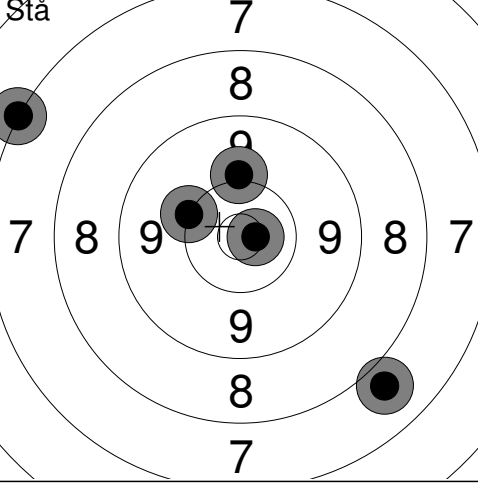
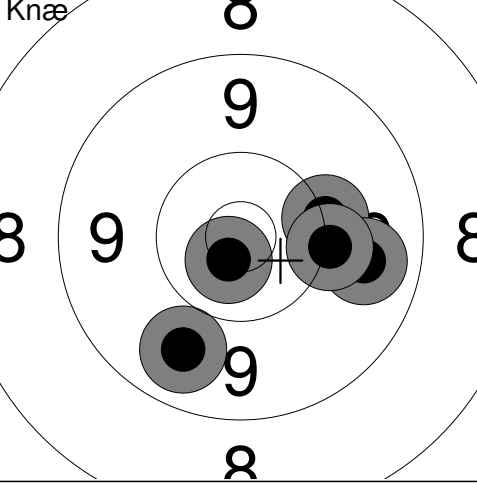
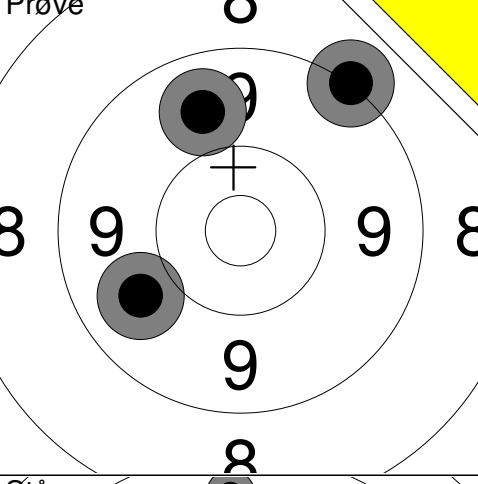
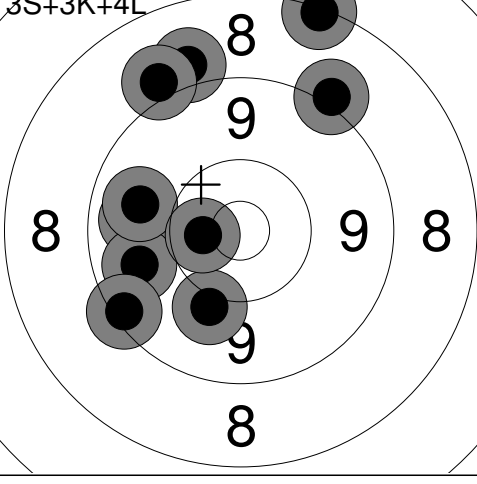
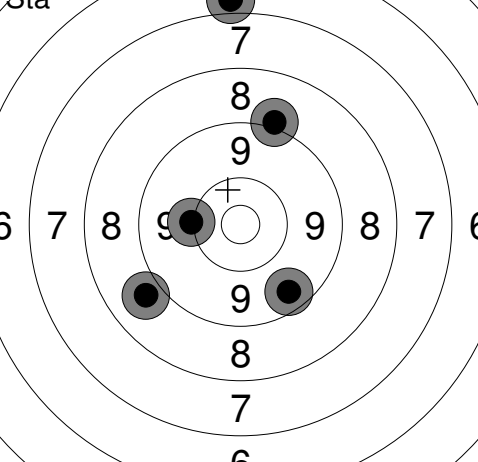

Hold	Skive	Svend Bissø	
560	14		
50 meter afsnit 2		Samsø Skytteforening	
		SEN	
		Landsstævne 2017	
		Aalborg Skyttekreds	
Prøve		1: 10.0 ↘ 2: 10.4 ↙ 3: 10.8x ↘ 4: 10.7x → 5: 10.2 ↗ 6: 10.1 ↘ 7: 10.0 ↘ 8: 9.7 ←	Ligg
		Serie 79.0 Total 0.0	
			1: 10.2 ↘ 2: 10.2 ↘ 3: 10.4 ← 4: 10.7x ↗ 5: 10.0 ←
			Serie 50.0 Total 50.0
Stå		1: 10.1 ↑ 2: 7.2 ↗ 3: 7.9 ↘ 4: 10.7x → 5: 10.2 ↗	Knæ
		Serie 44.0 Total 94.0	
			1: 9.7 ↘ 2: 10.1 → 3: 9.8 → 4: 10.1 → 5: 10.7x ↘
			Serie 48.0 Total 142.0
Prøve		1: 9.2 ↗ 2: 9.8 ← 3: 9.8 ↗	3S+3K+4L
		Serie 27.0 Total 142.0	
			1: 9.1 ↗ 2: 8.2 ↑ 3: 9.8 ← 4: 8.9 ↗ 5: 9.7 ← 6: 9.8 ← 7: 9.0 ↗ 8: 10.0 ↘ 9: 10.5x ← 10: 9.3 ↘
			Serie 90.0 Total 232.0
Stå		1: 6.9 ↑ 2: 9.1 ↑ 3: 8.9 ↘ 4: 10.1 ← 5: 9.5 ↘	
		Serie 42.0 Total 274.0	

Hold	Skive	Bjarne Veile		
560	15			
50 meter afsnit 2		Fløng-Hedehusene Skytteforening		
		SEN		
		Landsstævne 2017	Aalborg Skyttekreds	
Prøve		1: 9.6 ← 2: 10.1 ↙ 3: 10.1 ← 4: 10.4 → 5: 10.8x ↓ 6: 10.4 ↑ 7: 10.8x ← 8: 10.9x ↗ 9: 10.1 ↑ 10: 10.6x ← Serie 99.0 Total 0.0	Ligg	 1: 10.4x → 2: 10.7x ↑ 3: 10.6x ↗ 4: 10.4 ↗ 5: 10.8x ↗ Serie 50.0 Total 50.0
Stå		1: 10.6x ↑ 2: 10.4 ↗ 3: 9.8 ↓ 4: 10.3 ↓ 5: 10.2 → Serie 49.0 Total 99.0	Knæ	 1: 10.4 ↑ 2: 10.3 ↗ 3: 10.5x ↓ 4: 10.4 ← 5: 10.2 → Serie 50.0 Total 149.0
Prøve		1: 10.1 ↗ 2: 9.3 → 3: 10.3 ↗ 4: 9.4 ← Serie 38.0 Total 149.0	3S+3K+4L	 1: 9.5 ↓ 2: 10.2 ↑ 3: 10.2 ↙ 4: 10.2 ← 5: 10.1 ↓ 6: 9.4 ↓ 7: 10.8x ↙ 8: 10.2 ↓ 9: 10.3 ↓ 10: 10.1 ← Serie 98.0 Total 247.0
Stå		1: 9.9 ↗ 2: 9.1 ← 3: 9.4 ↗ 4: 10.5x ↓ 5: 10.3 → Serie 47.0 Total 294.0		

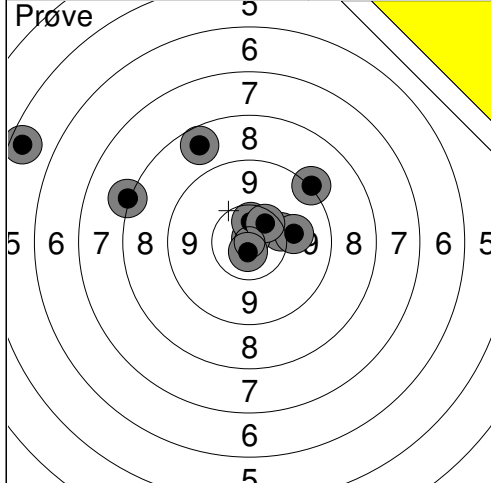

1:	8.1	←
2:	5.5	←
3:	8.6	↗
4:	9.1	↗
5:	10.3	→
6:	10.9x	↑
7:	10.0	→
8:	10.5x	↑
9:	10.4x	↗
10:	10.7x	↓
Serie		90.0
Total		0.0

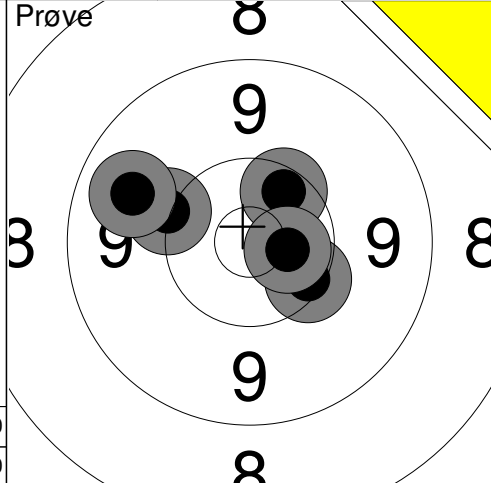

11:	10.3	↘
12:	10.1	↖
13:	9.7	↖
14:	10.4	↗
15:	10.6x	→
Serie		49.0
Total		0.0

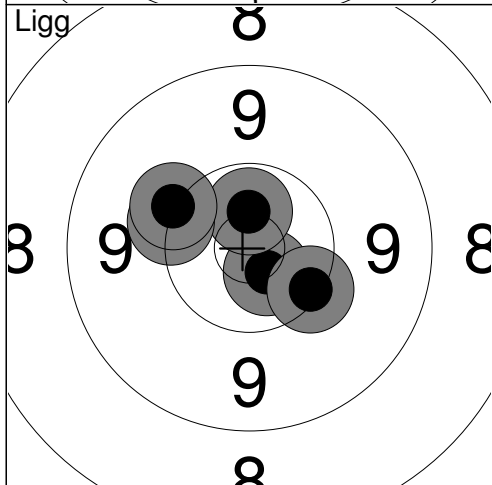

1:	10.7x	↘
2:	10.3	↘
3:	10.6x	↑
4:	10.2	↖
5:	10.1	↖
Serie		50.0
Total		50.0

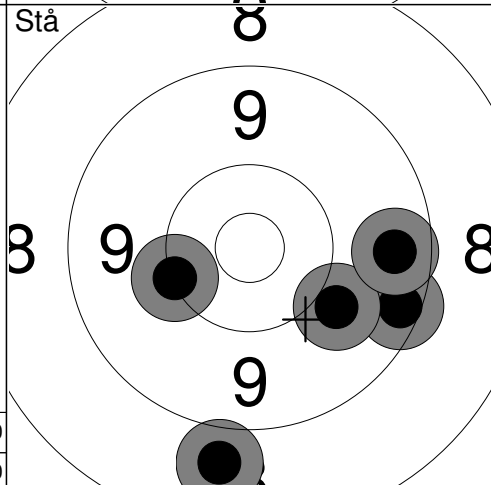

1:	9.4	→
2:	8.8	↓
3:	10.0	↘
4:	10.2	↖
5:	9.6	→
Serie		46.0
Total		96.0

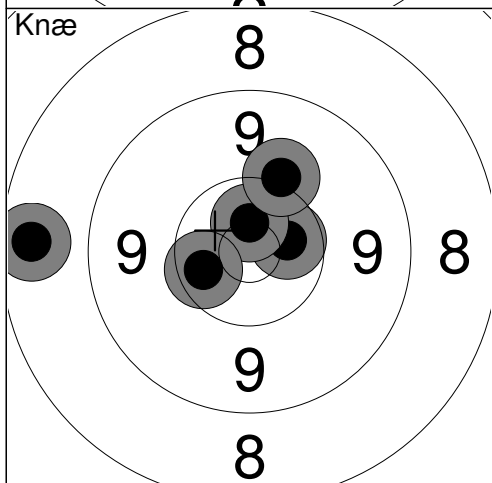

1:	8.5	←
2:	10.5x	→
3:	10.6x	↑
4:	10.1	↗
5:	10.4x	←
Serie		48.0
Total		144.0

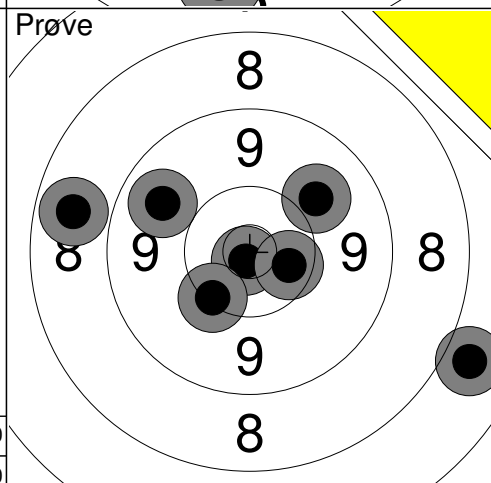

1:	9.7	↖
2:	10.8x	↘
3:	8.7	↖
4:	10.4x	→
5:	10.2	↘
6:	7.8	↘
7:	9.9	↗
Serie		63.0
Total		144.0

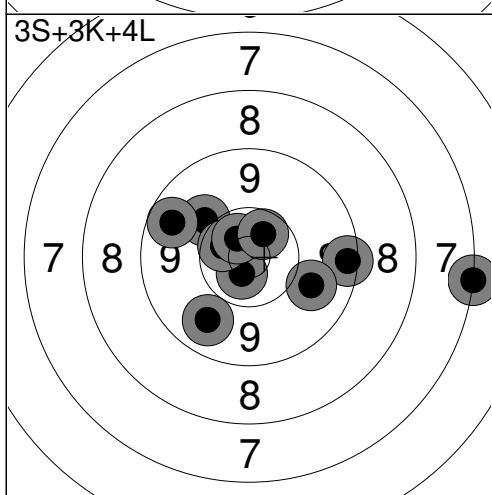

1:	9.4	→
2:	10.7x	↘
3:	7.2	→
4:	9.9	↘
5:	10.0	↗
6:	9.6	↗
7:	10.5x	↖
8:	9.7	↘
9:	10.6x	↗
10:	10.5x	↗
Serie		93.0
Total		237.0

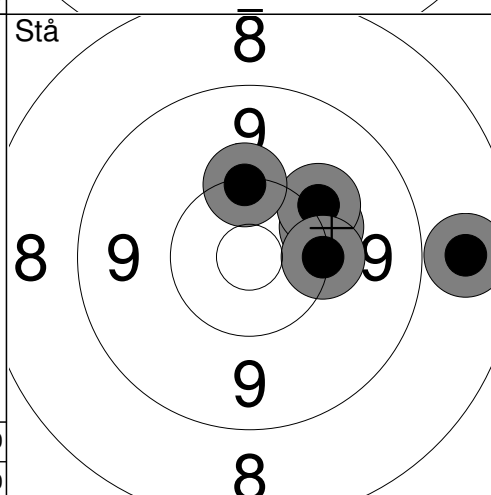

1:	8.7	→
2:	10.2	↗
3:	10.1	↗
4:	10.2	↑
5:	10.2	→
Serie		48.0
Total		285.0

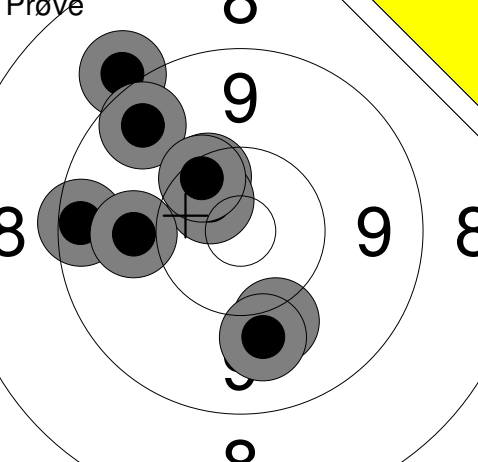
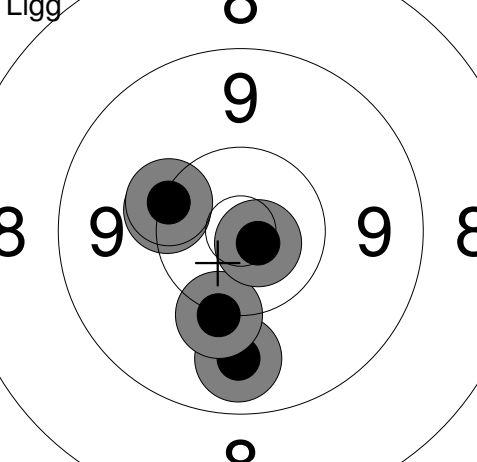
<b>Prøve</b> 	1: 9.0 ↗ 2: 9.6 ↗ 3: 10.0 ↘ 4: 10.4 ↗ 5: 9.4 ← 6: 9.9 ↘ 7: 10.5x ↗ 8: 10.3 ↗ 9: 10.0 ← <hr/> Serie 86.0 Total 0.0	<b>Ligg</b> 	1: 9.7 ↓ 2: 10.1 ↓ 3: 10.2 ↗ 4: 10.8x ↘ 5: 10.2 ↗ <hr/> Serie 49.0 Total 49.0
--	---	---	---

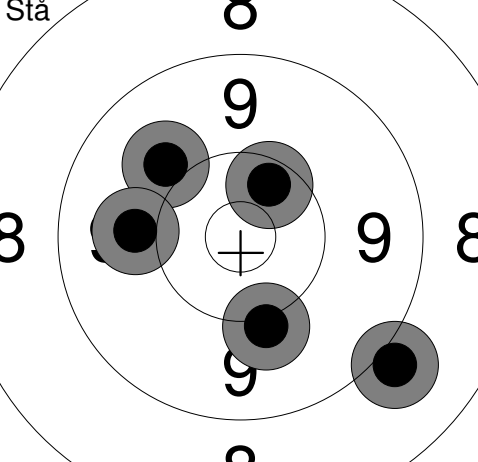
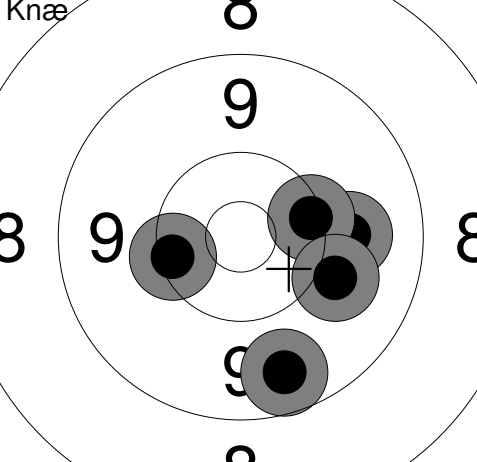
<b>Stå</b> 	1: 9.0 ↘ 2: 10.0 ↗ 3: 10.4 ↗ 4: 10.1 ↘ 5: 10.0 ← <hr/> Serie 49.0 Total 98.0	<b>Knæ</b> 	1: 9.9 → 2: 9.6 ↓ 3: 10.3 → 4: 10.0 ↘ 5: 10.3 ← <hr/> Serie 48.0 Total 146.0
---	--	---	--

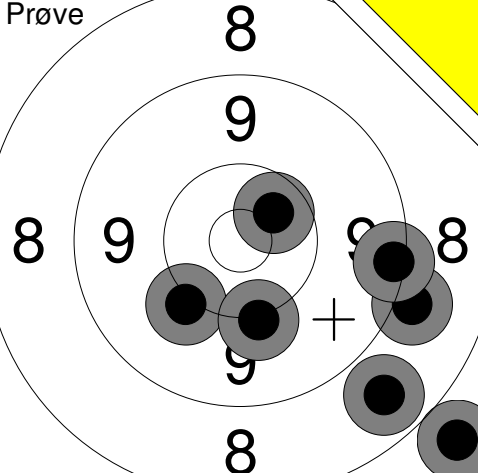
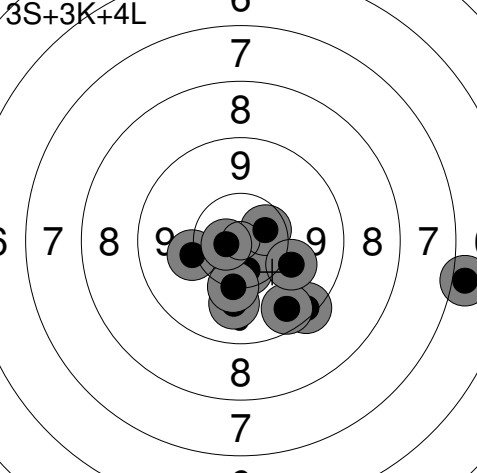
<b>Prøve</b> 	1: 10.1 ↘ 2: 9.0 → 3: 8.7 ↘ 4: 7.7 ↘ 5: 10.5x ↗ 6: 10.1 ↘ 7: 9.3 ↘ <hr/> Serie 63.0 Total 146.0	<b>3S+3K+4L</b> 	1: 9.9 ↓ 2: 6.9 → 3: 9.3 ↘ 4: 9.6 ↘ 5: 10.1 ← 6: 10.4x ↘ 7: 10.2 ↘ 8: 10.5x → 9: 10.0 → 10: 10.7x ← <hr/> Serie 93.0 Total 239.0
--	---	---	---

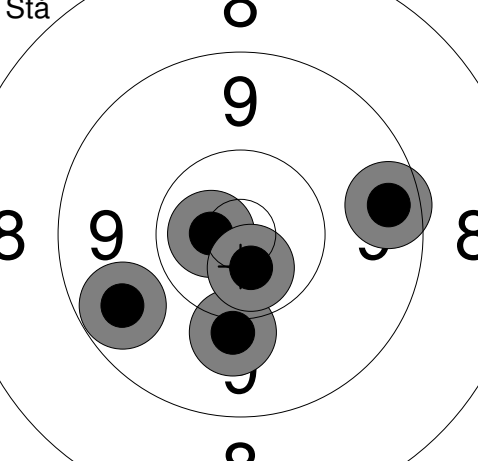
<b>Stå</b> 	1: 10.7x ← 2: 10.0 ↓ 3: 9.6 ← 4: 9.5 → 5: 10.6x ↓ <hr/> Serie 48.0 Total 287.0		
--	--	--	--

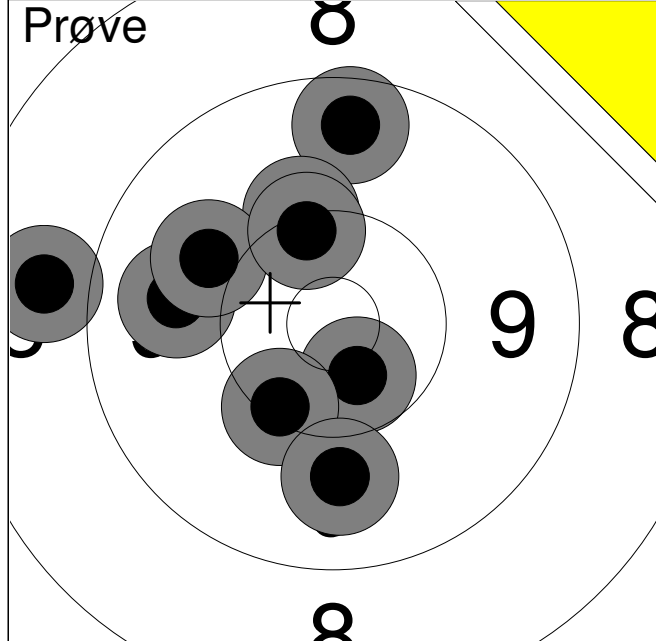

1:	9.5	↑
2:	9.8	←
3:	10.6x	↓
4:	10.2	↑
5:	10.3	↓
6:	10.0	↖
7:	9.9	↓
8:	10.3	↑
9:	8.8	←
<b>Serie</b>		<b>85.0</b>
<b>Total</b>		<b>0.0</b>

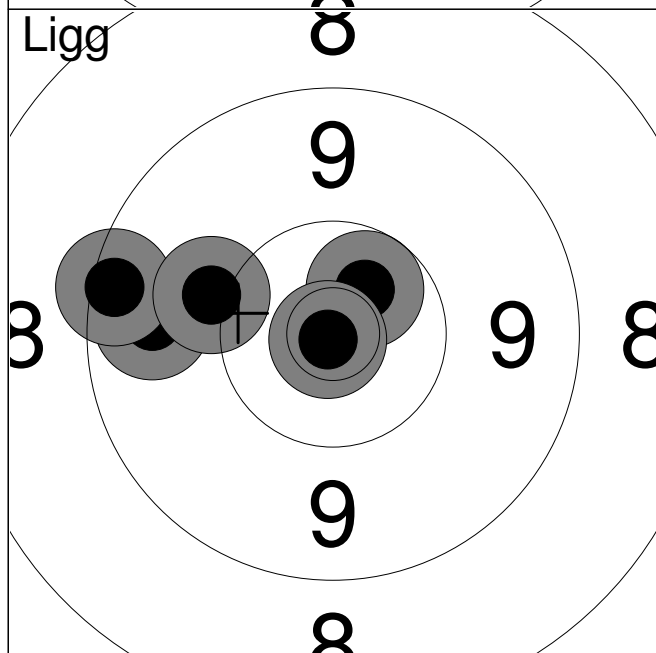

1:	10.6x	↗
2:	9.7	←
3:	9.3	←
4:	10.1	←
5:	10.9x	↙
<b>Serie</b>		<b>48.0</b>
<b>Total</b>		<b>48.0</b>

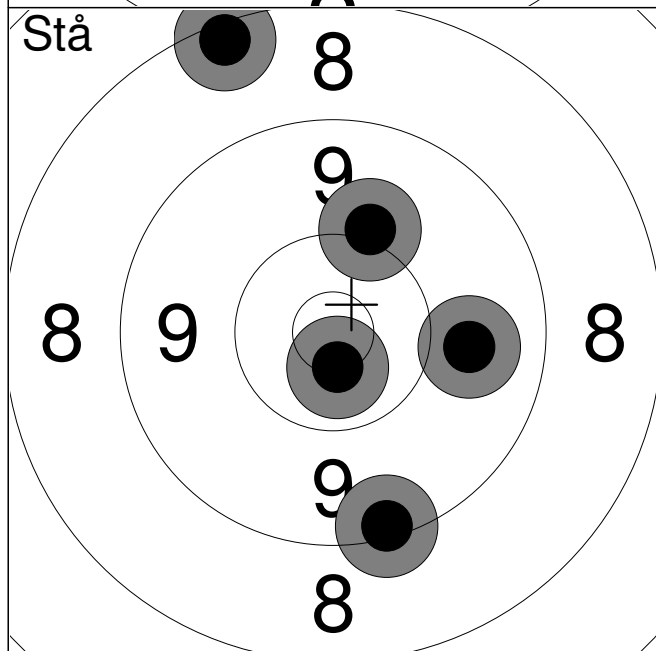

1:	8.3	↑
2:	9.3	↓
3:	10.7x	↓
4:	10.1	↑
5:	9.8	→
<b>Serie</b>		<b>46.0</b>
<b>Total</b>		<b>94.0</b>

Hold	Skive	Niels Hybholt	
560	19	Videbæk Skytteforening	
50 meter afsnit 2		SEN	
Landsstævne 2017		Aalborg Skyttekreds	
<b>Prøve</b> 	1: 6.8 ↗ 2: 10.4x ↗ 3: 10.4x ↑ 4: 10.6x ← 5: 10.1 → 6: 10.3 ↗ 7: 9.8 ← 8: 9.3 ↑ 9: 10.2 ← 10: 10.3 ↓ Serie 94.0 Total 0.0	<b>Ligg</b> 	1: 10.8x ↓ 2: 10.1 ← 3: 10.1 ↗ 4: 10.3 ↗ 5: 9.8 ↗ Serie 49.0 Total 49.0
<b>Stå</b> 	1: 7.7 ↓ 2: 7.6 ↗ 3: 9.0 → 4: 7.4 ↗ 5: 8.8 ↗ Serie 38.0 Total 87.0	<b>Knæ</b> 	1: 9.2 ↓ 2: 10.0 ↓ 3: 10.1 ← 4: 9.5 → 5: 9.2 ← Serie 47.0 Total 134.0
<b>Prøve</b> 	1: 10.0 ↓ 2: 8.7 ↗ 3: 6.4 ↗ 4: 0.0 ↑ 5: 9.3 ↗ 6: 9.1 ↗ Serie 42.0 Total 134.0	<b>3S+3K+4L</b> 	1: 9.0 → 2: 9.9 ↓ 3: 10.3 ↑ 4: 9.2 → 5: 9.8 ↓ 6: 10.5x ↓ 7: 10.5x ↓ 8: 10.4 ↓ 9: 10.2 ← 10: 10.7x ↗ Serie 96.0 Total 230.0
<b>Stå</b> 	1: 8.9 ← 2: 8.0 ↓ 3: 9.9 ↗ 4: 9.3 ← 5: 9.9 ↗ Serie 43.0 Total 273.0		

Hold	Skive	Jens Bo Laursen	
560	20		
50 meter afsnit 2		Honum og Omegns Skytteforening	
		SEN	
		Landsstævne 2017	Aalborg Skyttekreds
Prøve		1: 9.9 → 2: 10.6x ↘ 3: 10.5x ↑ 4: 9.8 ↘ 5: 10.4 ← 6: 10.5x ↗	Ligg
		Serie 58.0 Total 0.0	
			1: 10.4 ↘ 2: 10.3 ↘ 3: 10.7x ↘ 4: 10.5x ↘ 5: 10.3 →
Stå		1: 9.6 ← 2: 10.2 → 3: 8.9 ↘ 4: 10.2 ↘ 5: 10.0 ↘	Knæ
		Serie 47.0 Total 97.0	
			1: 8.3 ↙ 2: 10.1 ↘ 3: 9.1 ↘ 4: 10.2 → 5: 9.9 ↗
Prøve		1: 9.9 ↙ 2: 9.8 ← 3: 9.2 ↘	3S+3K+4L
		Serie 27.0 Total 143.0	
			1: 10.8x ↗ 2: 9.1 ← 3: 7.7 → 4: 9.3 ↘ 5: 8.5 ↘ 6: 10.3 → 7: 9.4 → 8: 9.8 → 9: 9.7 ↘ 10: 10.8x ↘
Stå		1: 9.6 ← 2: 9.3 ↘ 3: 10.0 → 4: 7.8 ↘ 5: 9.5 ↘	
		Serie 44.0 Total 277.0	

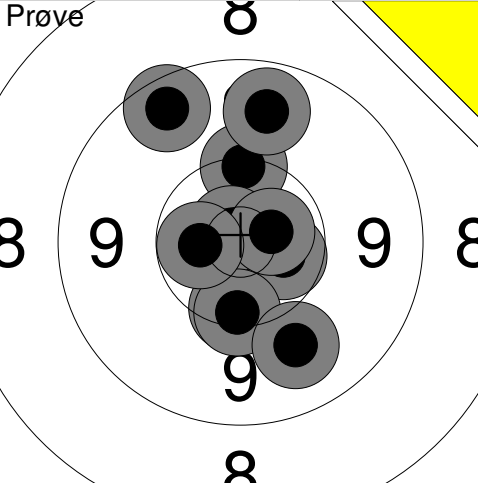
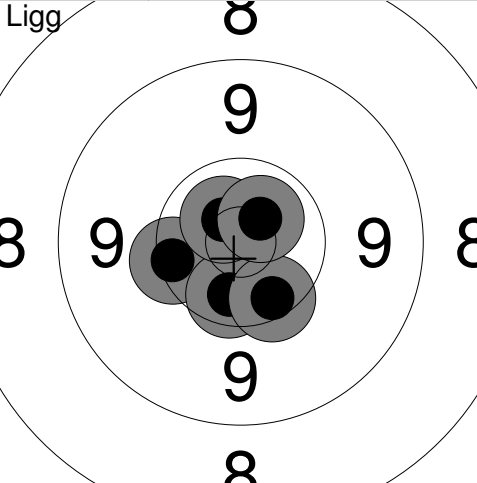
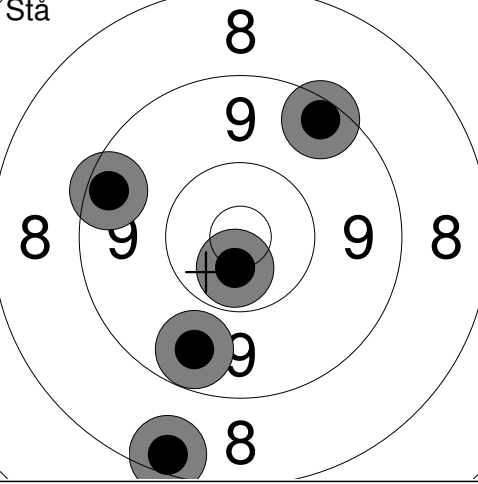
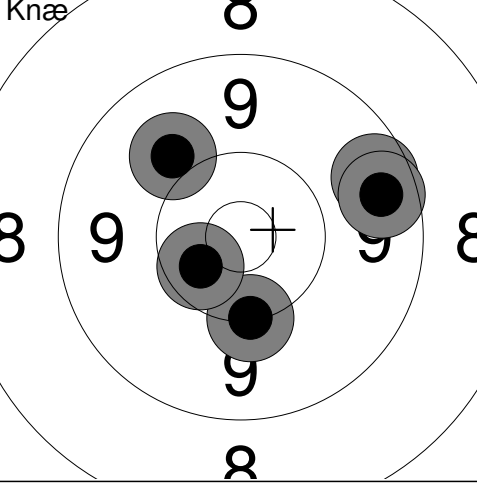
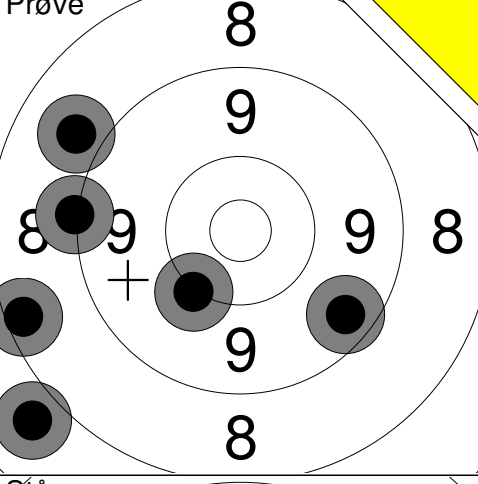
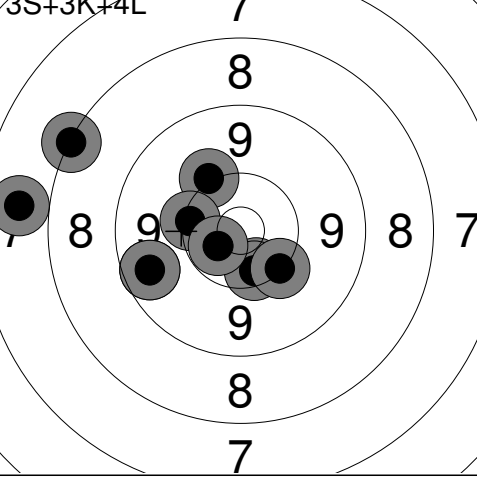
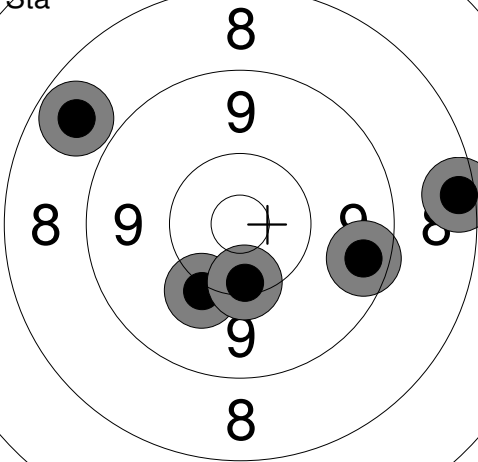
Hold	Skive	Allan Clausen	
561	13	50 meter afsnit 2	Skive Skytteforening
		SEN	
		Landsstævne 2017	Aalborg Skyttekreds
Prøve		1: 9.5 ↗ 2: 10.2 ↑ 3: 9.7 ↑ 4: 10.3 ↓ 5: 10.5x → 6: 10.8x ↗ 7: 10.3 ↓ 8: 10.6x → 9: 9.9 ↓ 10: 10.6x ←	Ligg
		Serie 97.0	
		Total 0.0	1: 10.3 ← 2: 10.5x ↓ 3: 10.7x ↗ 4: 10.3 ↓ 5: 10.7x ↗
Stå		1: 8.4 ↓ 2: 9.4 ↗ 3: 10.6x ↓ 4: 9.6 ↓ 5: 9.4 ↖	Knæ
		Serie 45.0	
		Total 95.0	1: 9.5 → 2: 10.2 ↓ 3: 9.5 → 4: 10.0 ↗ 5: 10.5x ↖
Prøve		1: 7.8 ↖ 2: 8.4 ← 3: 10.1 ↖ 4: 9.5 ↓ 5: 9.1 ↗ 6: 8.9 ↗	3S+3K+4L
		Serie 51.0	
		Total 143.0	1: 10.4 ↓ 2: 10.4 ↓ 3: 8.2 ↗ 4: 10.1 ↗ 5: 7.7 ← 6: 10.2 ← 7: 9.6 ← 8: 9.6 ← 9: 10.2 ↓ 10: 10.6x ↖
Stå		1: 8.4 → 2: 9.5 ↓ 3: 10.1 ↖ 4: 10.3 ↓ 5: 8.7 ↗	
		Serie 45.0	
		Total 281.0	

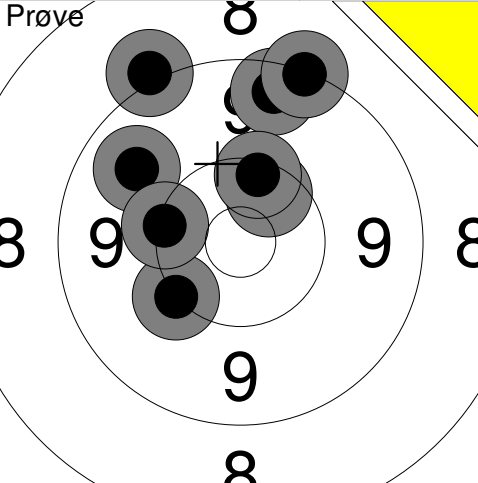
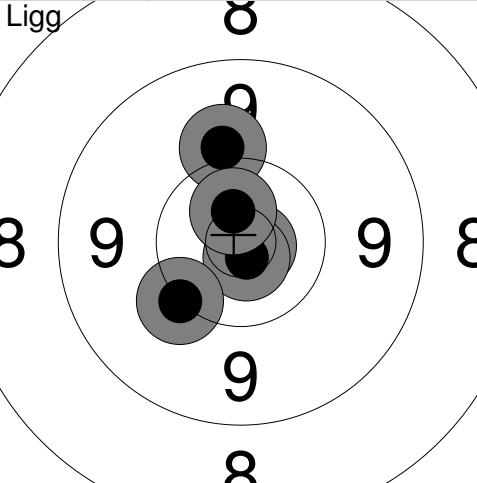
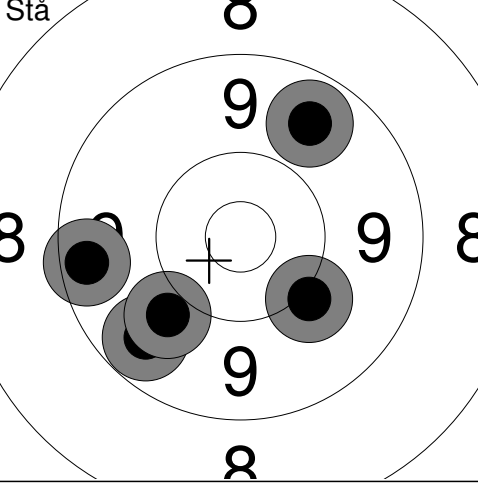
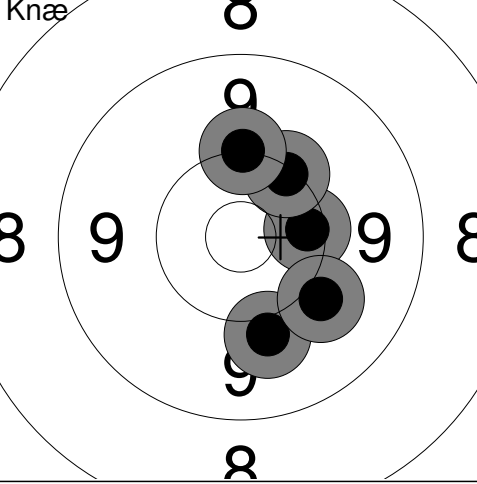
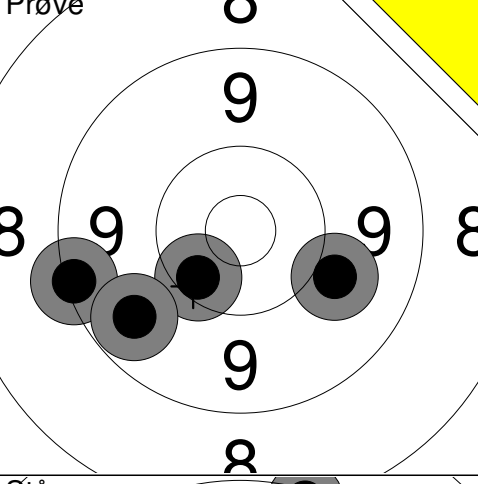
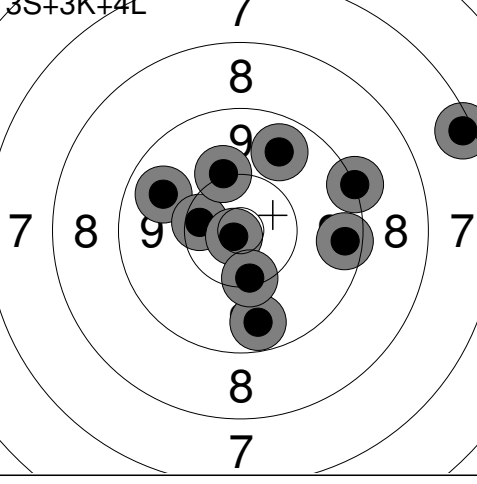
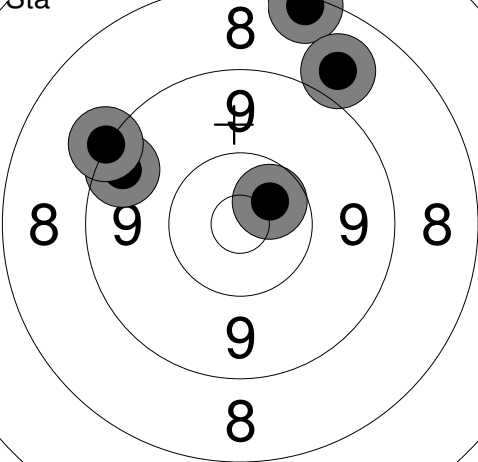

Hold	Skive	Marianne Clausen	
561	14		
50 meter afsnit 2		Grænseegnens Skytteforening	
		SEN	
		Landsstævne 2017	
		Aalborg Skyttekreds	
Prøve		1: 9.1 ↗ 2: 9.7 ↘ 3: 10.2 ↙ 4: 9.5 ↗ 5: 10.2 ↖ 6: 10.4x ↗ 7: 9.2 ↗ 8: 10.3 ↗	Ligg
		Serie 76.0 Total 0.0	
			1: 10.8x → 2: 10.8x ↓ 3: 10.0 ↗ 4: 10.7x ↗ 5: 10.2 ↖
			Serie 50.0 Total 50.0
Stå		1: 9.5 ← 2: 9.7 ↗ 3: 9.6 ↙ 4: 10.0 ↙ 5: 10.1 ↘	Knæ
		Serie 47.0 Total 97.0	
			1: 10.3 → 2: 10.0 ↓ 3: 10.2 ↗ 4: 10.1 ↗ 5: 10.0 ↘
			Serie 50.0 Total 147.0
Prøve		1: 10.4 ↙ 2: 9.3 ← 3: 9.6 ↙ 4: 10.0 ↘	3S+3K+4L
		Serie 38.0 Total 147.0	
			1: 7.3 → 2: 9.7 ↖ 3: 10.4 ← 4: 9.6 ↓ 5: 10.8x ↙ 6: 10.3 ↓ 7: 9.4 → 8: 9.2 → 9: 10.1 ↗ 10: 9.7 ↗
			Serie 92.0 Total 239.0
Stå		1: 9.5 ↖ 2: 9.2 ↖ 3: 8.3 ↗ 4: 10.5x ↗ 5: 8.8 ↗	
		Serie 44.0 Total 283.0	

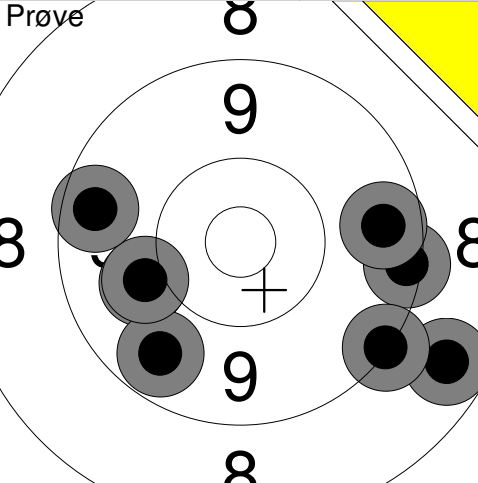
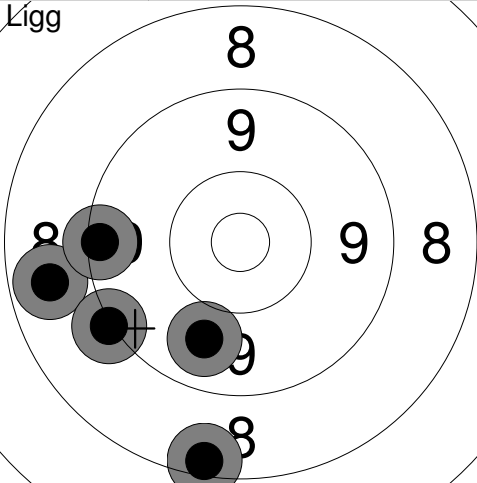
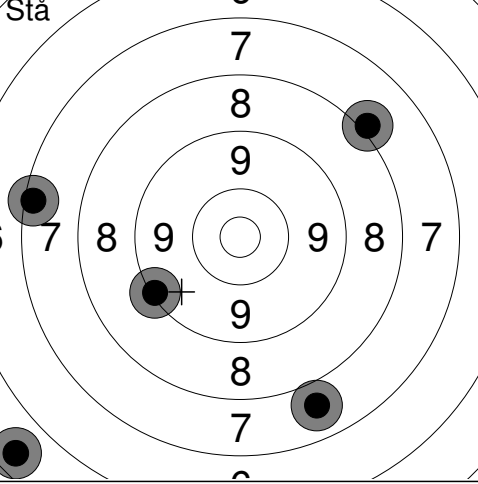
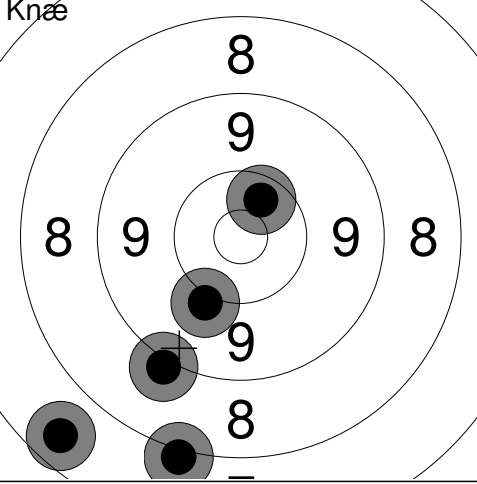
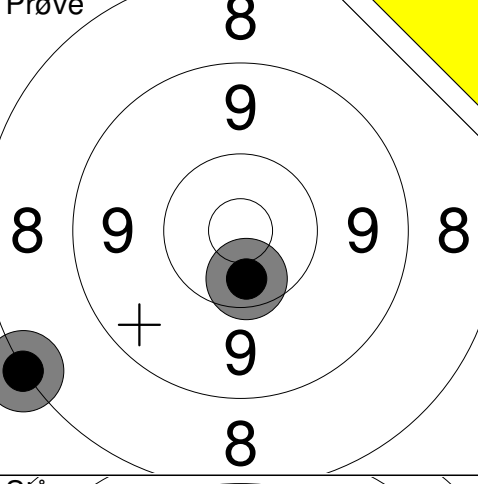
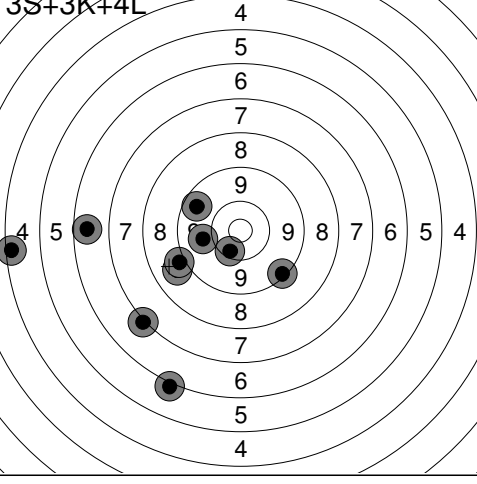
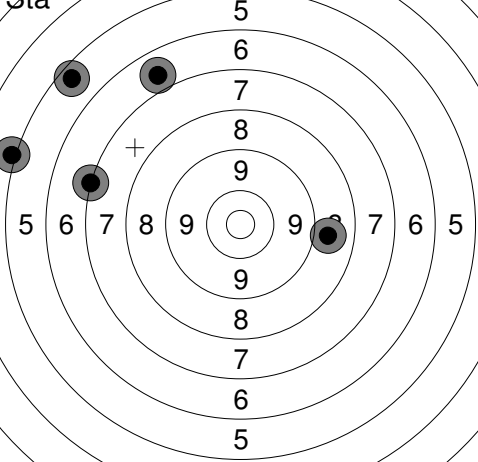
Hold	Skive	Mogens Dankert	
561	15		
50 meter afsnit 2		Grænseegnens Skytteforening	
		SEN	
		Landsstævne 2017	
		Aalborg Skyttekreds	
Prøve		1: 9.3 → 2: 9.6 → 3: 10.0 ← 4: 8.6 ↓ 5: 9.2 ↓ 6: 9.6 ↓ 7: 10.0 ← 8: 9.5 ←	Ligg
		Serie 73.0 Total 0.0	
		Serie 43.0 Total 43.0	1: 8.7 ← 2: 9.8 ↓ 3: 8.4 ↓ 4: 9.3 ← 5: 9.1 ←
Stå		1: 7.3 ← 2: 9.2 ← 3: 7.8 ↓ 4: 8.1 → 5: 5.5 ←	Knæ
		Serie 36.0 Total 79.0	
		Serie 44.0 Total 123.0	1: 9.1 ↓ 2: 7.6 ← 3: 10.1 ↓ 4: 10.4x ↗ 5: 8.1 ↓
Prøve		1: 10.5x ↓ 2: 8.2 ←	3S+3K+4L
		Serie 18.0 Total 123.0	
		Serie 77.0 Total 200.0	1: 6.6 ← 2: 9.9 ← 3: 10.3 ↓ 4: 9.3 ↓ 5: 4.3 ← 6: 6.0 ↓ 7: 7.1 ← 8: 9.6 ↗ 9: 8.9 ← 10: 9.0 ←
Stå		1: 6.8 ↗ 2: 8.8 → 3: 7.2 ↗ 4: 5.5 ↗ 5: 5.1 ↗	
		Serie 31.0 Total 231.0	

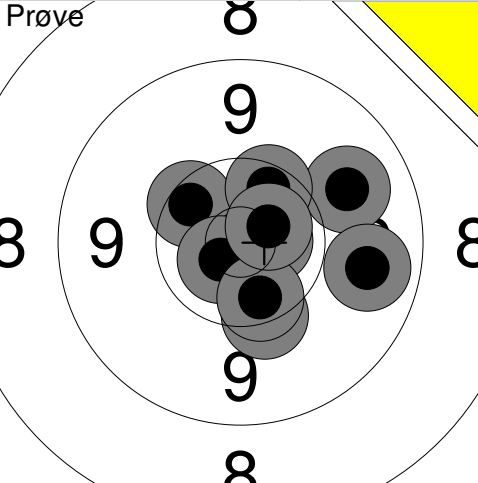
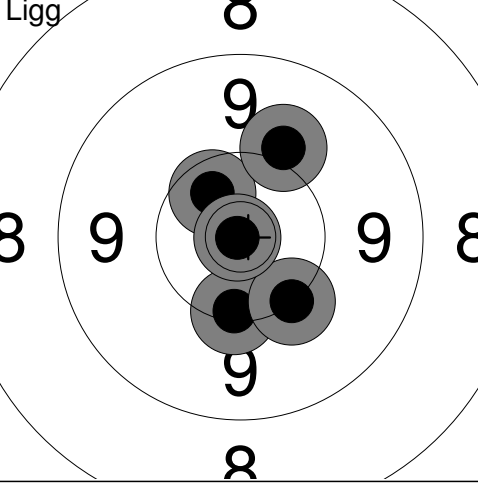
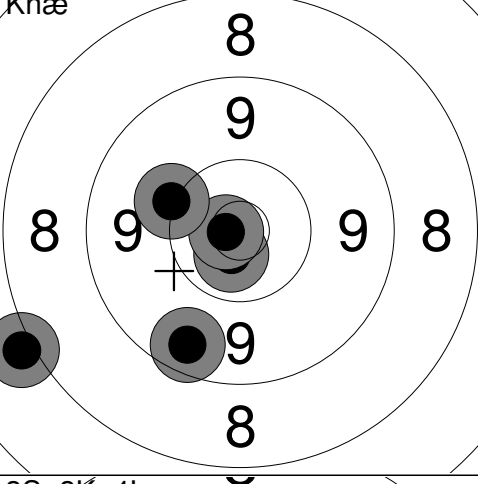
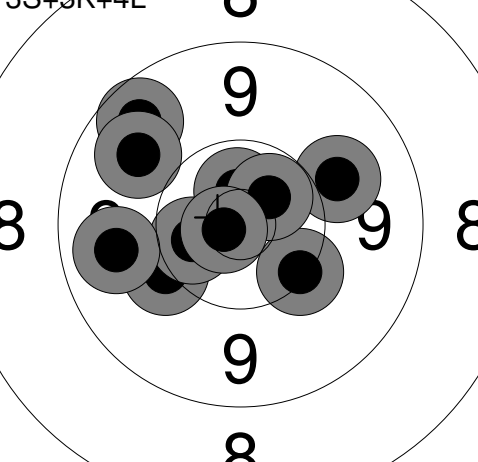
Hold	Skive	Gert M. Jensen	
561	16		
50 meter afsnit 2		Boddum-Ydby Skytteforening	
		SEN	
		Landsstævne 2017	Aalborg Skyttekreds
Prøve		1: 10.2 ↓ 2: 10.4 ↗ 3: 9.8 → 4: 10.8x ↓ 5: 9.7 → 6: 10.7x → 7: 10.4 ↗ 8: 10.7x ↙ 9: 10.4 ↓ 10: 10.6x ↗	Prøve
		Serie 98.0	11: 10.3 →
		Total 0.0	Serie 10.0
			Total 0.0
Ligg		1: 10.5x ↗ 2: 10.0 ↗ 3: 10.3 ↓ 4: 10.2 ↓ 5: 10.9x ←	Stå
		Serie 50.0	1: 9.9 ↘
		Total 50.0	2: 8.3 →
			3: 10.0 →
			4: 10.4 ↗
			5: 8.3 ←
			Serie 45.0
			Total 95.0
Knæ		1: 10.7x ↓ 2: 9.5 ↓ 3: 10.8x ← 4: 8.0 ← 5: 10.1 ↗	Prøve
		Serie 47.0	1: 9.6 ↗
		Total 142.0	2: 10.9x ↙
			3: 10.0 ↙
			4: 10.7x ↗
			Serie 39.0
			Total 142.0
3S+3K+4L		1: 10.1 ← 2: 9.9 → 3: 9.6 ↗ 4: 10.5x ← 5: 10.6x ↗ 6: 10.2 ↓ 7: 9.7 ← 8: 10.6x ↗ 9: 9.8 ↗ 10: 10.8x ←	Stå
		Serie 96.0	1: 9.3 ↗
		Total 238.0	2: 9.6 ↓
			3: 10.0 ←
			4: 10.6x ↗
			5: 9.1 ↙
			Serie 47.0
			Total 285.0

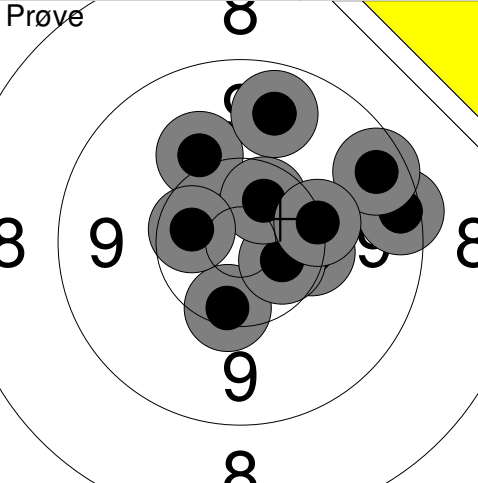
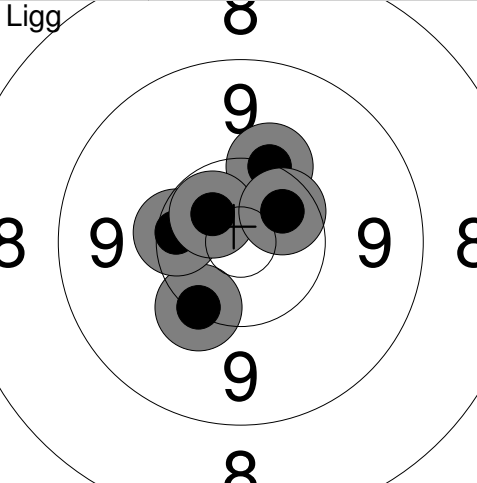
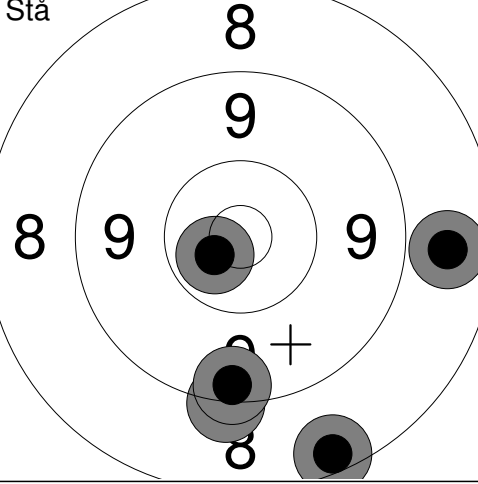
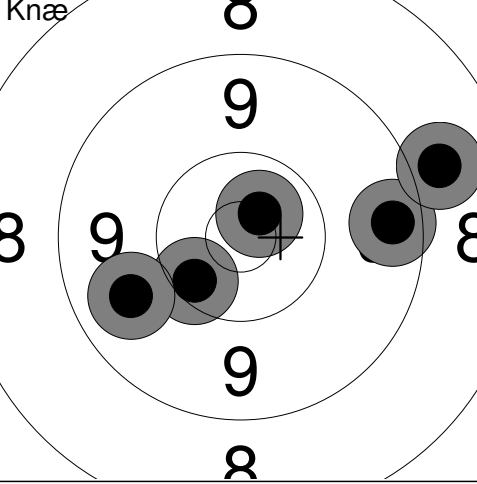
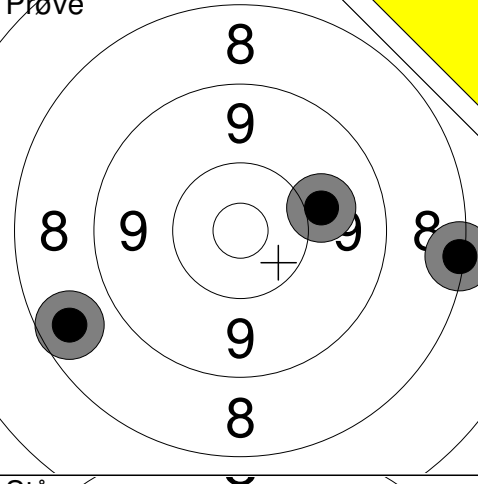
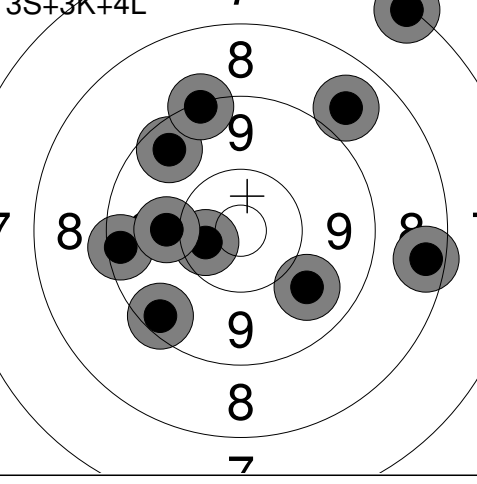
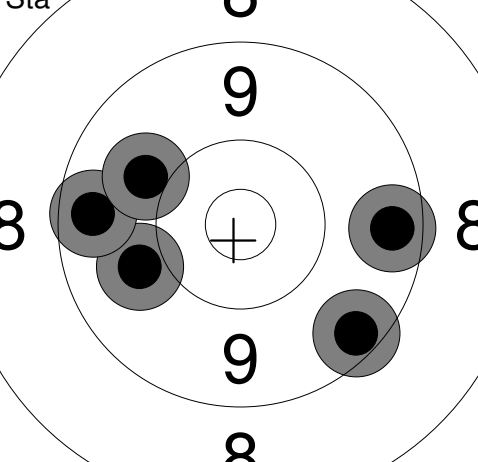
Hold	Skive	Jon Luckmann Hansen			
561	17				
50 meter afsnit 2		Greve Skytteforening			
		SEN			
		Landsstævne 2017			
		Aalborg Skyttekreds			
Prøve		1: 9.4 → 2: 10.3 ↓ 3: 10.1 ↑ 4: 10.3 → 5: 9.7 ↑ 6: 9.5 → 7: 10.5x → 8: 10.5x ↑ 9: 10.2 → 10: 10.5x ←	Ligg		1: 10.2 ↓ 2: 10.2 ↑ 3: 10.3 ← 4: 10.6x ↖ 5: 10.5x ↗
		Serie 97.0			Serie 50.0
		Total 0.0			Total 50.0
Stå		1: 10.6x ← 2: 8.7 → 3: 9.2 ↓ 4: 8.4 ↓ 5: 9.4 ↓	Knæ		1: 9.5 → 2: 10.4 ↓ 3: 9.8 ← 4: 8.9 → 5: 10.7x ↑
		Serie 44.0			Serie 46.0
		Total 94.0			Total 140.0
Prøve		1: 10.0 → 2: 8.6 ← 3: 8.2 →	3S+3K+4L		1: 8.4 → 2: 7.2 ↑ 3: 8.8 ↑ 4: 9.4 ↓ 5: 9.4 ← 6: 9.8 ↓ 7: 9.5 ↑ 8: 10.5x ← 9: 10.0 ← 10: 9.2 ↑
		Serie 26.0			Serie 88.0
		Total 140.0			Total 228.0
Stå		1: 9.9 ← 2: 9.4 ↓ 3: 9.5 ← 4: 10.0 ↑ 5: 9.5 →			
		Serie 46.0			
		Total 274.0			

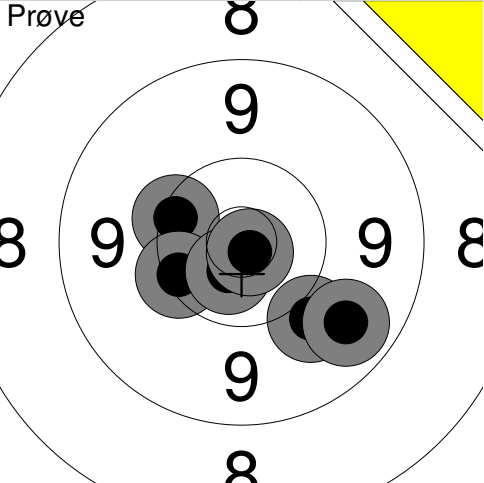
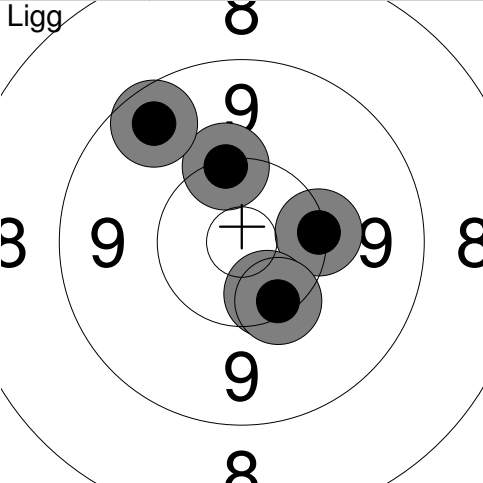
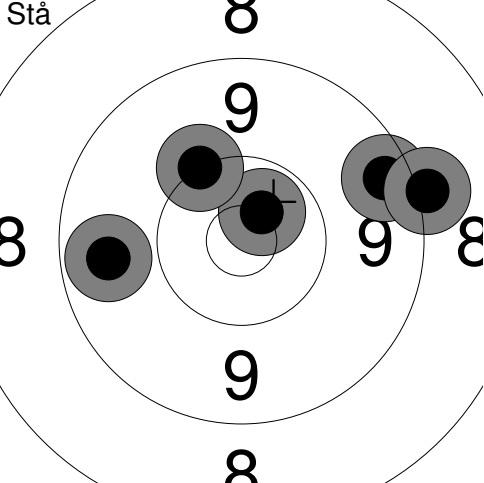
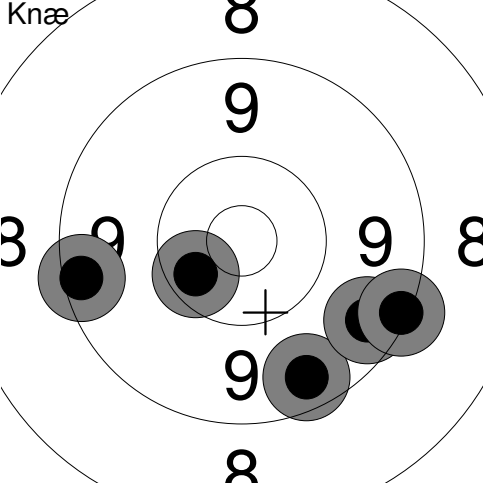
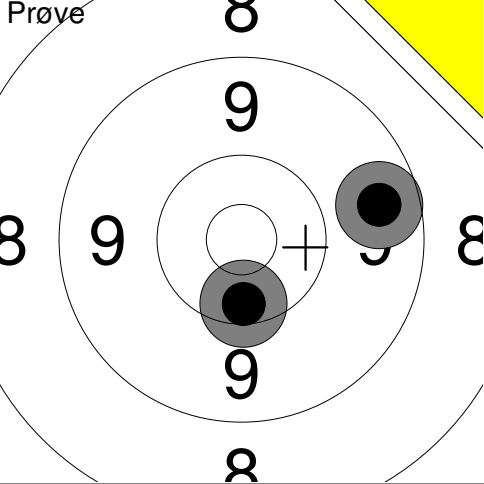
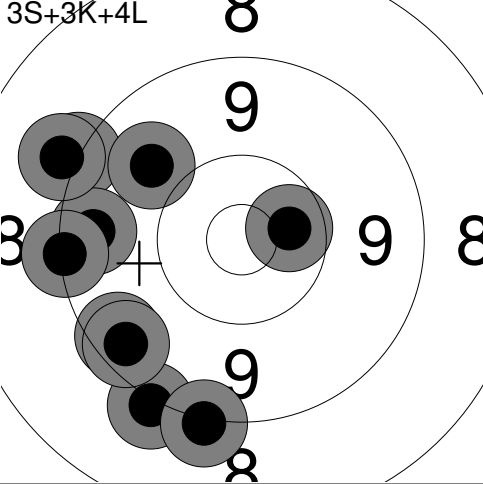
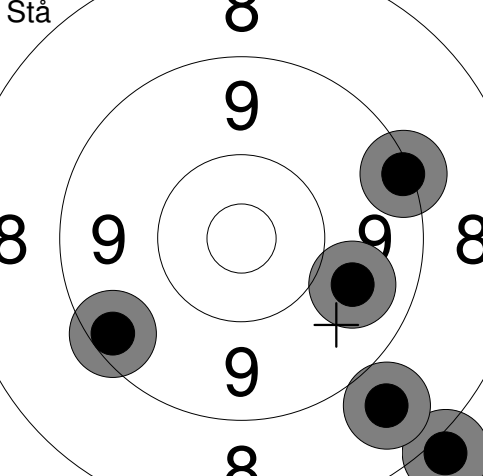
Hold	Skive	Eva E Rasmussen			
561	18	Eva E Rasmussen			
50 meter afsnit 2		Grænseegnens Skytteforening			
		SEN			
		Landsstævne 2017			
		Aalborg Skyttekreds			
Prøve		1: 10.3 ↖ 2: 10.0 ↘ 3: 9.7 ↘ 4: 10.3 ↖ 5: 10.7x ↘ 6: 10.8x ↘ Serie 59.0 Total 0.0	Ligg		1: 10.2 → 2: 10.4 ↘ 3: 10.2 ↖ 4: 9.5 ↖ 5: 10.3 ↘ Serie 49.0 Total 49.0
Stå		1: 9.4 → 2: 10.6x ↖ 3: 10.2 ↖ 4: 9.1 → 5: 9.7 ← Serie 47.0 Total 96.0	Knæ		1: 9.5 ↘ 2: 9.5 ↘ 3: 10.4x ↖ 4: 9.3 → 5: 9.4 ← Serie 46.0 Total 142.0
Prøve		1: 9.6 → 2: 10.3 ↘ Serie 19.0 Total 142.0	3S+3K+4L		1: 9.1 ↘ 2: 10.5x → 3: 9.2 ↖ 4: 9.4 ↖ 5: 9.5 ← 6: 9.0 ↖ 7: 9.1 ↘ 8: 9.2 ← 9: 9.4 ↖ 10: 9.9 ↖ Serie 91.0 Total 233.0
Stå		1: 9.4 ↖ 2: 9.8 ↘ 3: 9.3 → 4: 8.0 ↘ 5: 8.8 ↘ Serie 43.0 Total 276.0			

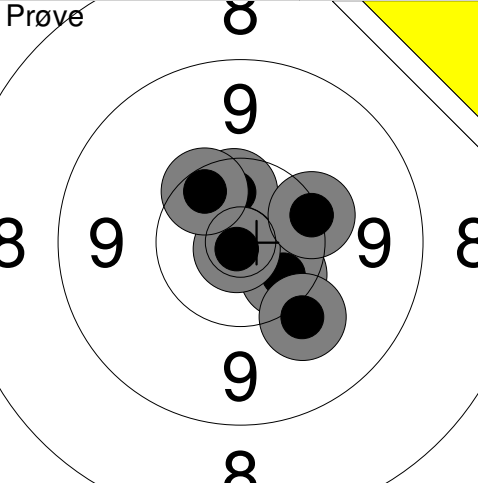
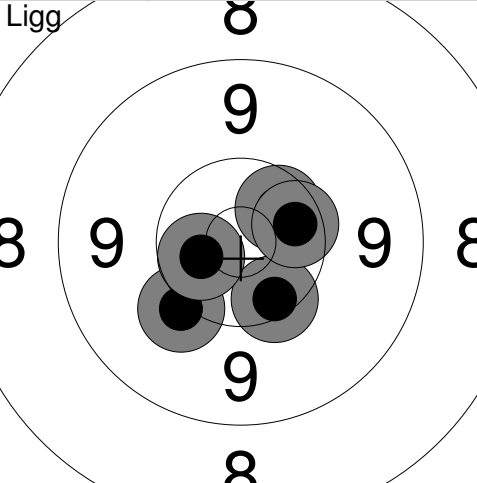
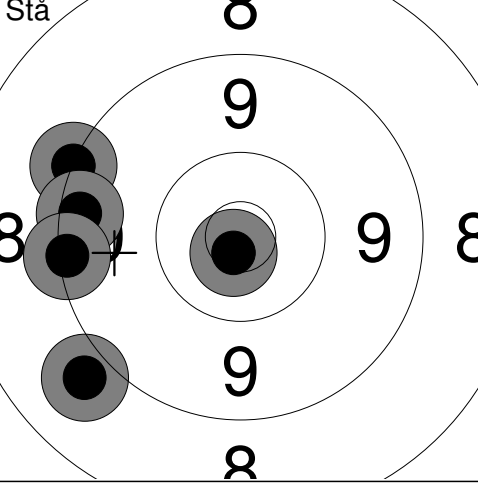
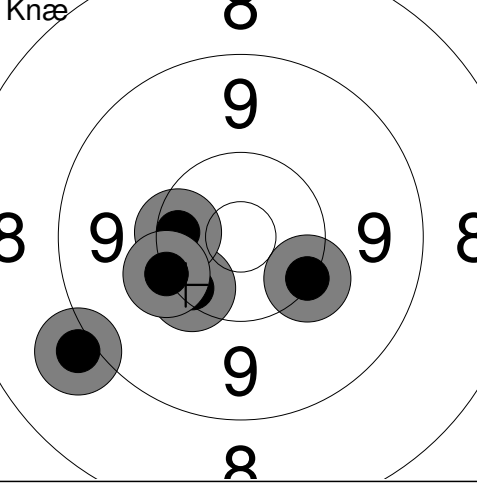
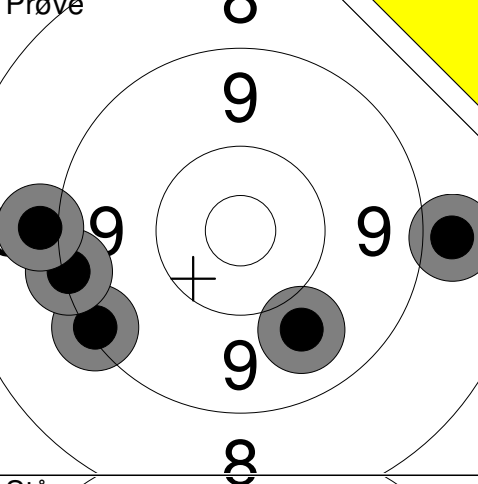
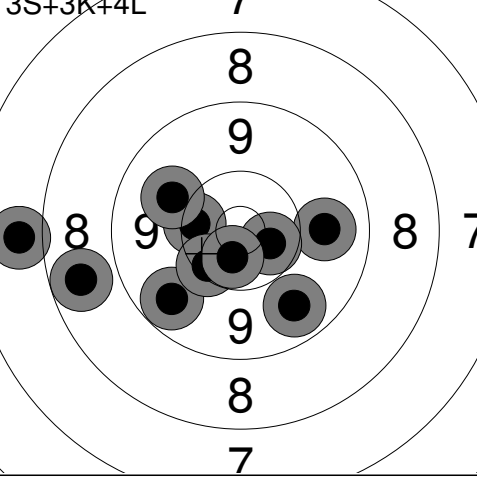
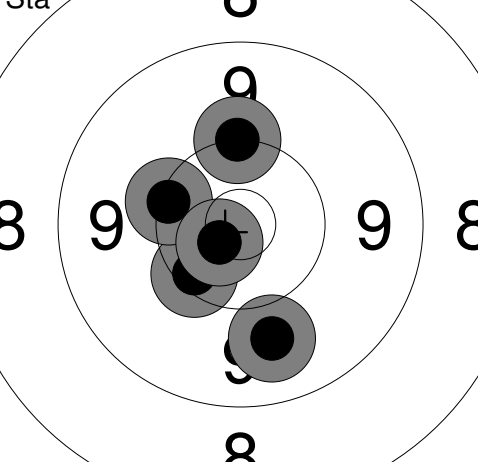
Hold	Skive	Anders Secher			
561	19	Ullerup Skytteforening	SEN		
50 meter afsnit 2	Landsstævne 2017	Aalborg Skyttekreds			
Prøve		1: 10.5x ↑ 2: 10.4x ↘ 3: 10.9x ↙ 4: 10.4 ↗ 5: 10.0 ↘ 6: 10.2 →	Ligg		1: 10.5x ↗ 2: 10.3 ↘ 3: 10.1 ↙ 4: 10.4x → 5: 10.6x ←
	Serie 60.0		Serie 50.0		
	Total 0.0		Total 50.0		
Stå		1: 9.2 ← 2: 9.4 ← 3: 9.3 ← 4: 8.9 ↙ 5: 10.8x ↘	Knæ		1: 9.0 ← 2: 10.2 → 3: 10.3 ↙ 4: 10.4 ← 5: 10.2 ←
	Serie 45.0		Serie 49.0		
	Total 95.0		Total 144.0		
Prøve		1: 9.3 ↙ 2: 8.9 → 3: 9.9 ↘ 4: 9.2 ← 5: 9.0 ←	3S+3K+4L		1: 9.6 ↙ 2: 7.9 ← 3: 9.8 → 4: 8.6 ← 5: 9.7 ↘ 6: 10.5x → 7: 10.3 ← 8: 10.3 ↙ 9: 9.9 ↗ 10: 10.6x ↘
	Serie 44.0		Serie 91.0		
	Total 144.0		Total 235.0		
Stå		1: 10.3 ↙ 2: 9.8 ↘ 3: 10.2 ↗ 4: 10.2 ↖ 5: 10.7x ↘			
	Serie 49.0				
	Total 284.0				

Hold	Skive	Knud Møller	
562	13	Samsø Skytteforening	
50 meter afsnit 2		LIG	
		Landsstævne 2017	Aalborg Skyttekreds
Prøve		1: 10.0 ↘ 2: 9.1 ↓ 3: 10.5x ↓ 4: 10.7x ↓ 5: 10.3 ↓ 6: 10.3 ↓ 7: 9.7 ↓ 8: 10.7x ↑ 9: 9.2 ↓ 10: 10.8x ←	1. Serie Ligg
		Serie 97.0 Total 0.0	 1: 10.6x ↓ 2: 10.5x ← 3: 10.5x ← 4: 10.5x ↘ 5: 10.8x ← 6: 10.7x ↑ 7: 10.6x ↓ 8: 10.0 ↓ 9: 10.6x → 10: 10.4 ↑ Serie 100.0 Total 100.0
2. Serie Ligg		1: 9.8 ← 2: 10.1 ↑ 3: 10.8x ↑ 4: 9.5 ↓ 5: 10.4 ↑	Prøve
		Serie 48.0 Total 148.0	 1: 10.8x ↓ 2: 10.7x ← 3: 10.4x ↗ 4: 10.4 ↗ 5: 10.3 ↓ 6: 10.5x ← Serie 60.0 Total 148.0
3. Serie Ligg		1: 10.7x ← 2: 10.8x ← 3: 10.7x ↓ 4: 10.7x ↑ 5: 10.1 ↑	4. Serie Ligg
		Serie 50.0 Total 198.0	 1: 10.8x ← 2: 10.8x ↓ 3: 10.3 ← 4: 9.7 ↓ 5: 10.5x ↑ Serie 49.0 Total 247.0
5. Serie Ligg		1: 10.3 ← 2: 10.6x ← 3: 10.3 ← 4: 10.8x ↓ 5: 10.1 ↑	
		Serie 50.0 Total 297.0	

Hold	Skive	Per Christiansen	
562	14	Samsø Skytteforening	
50 meter afsnit 2		LIG	
Landsstævne 2017		Aalborg Skyttekreds	
Prøve		1: 10.4 ↑ 2: 10.6x ↑ 3: 10.4 ↗ 4: 10.7x ↖ 5: 10.5x ↙ 6: 10.3 ↗ 7: 10.7x ↗	1. Serie Ligg
		Serie 70.0 Total 0.0	 1: 10.0 → 2: 10.6x ↓ 3: 10.4 ↗ 4: 10.6x ↑ 5: 10.6x ↑ 6: 10.6x ↗ 7: 10.7x ↗ 8: 9.8 ↗ 9: 10.8x ↑ 10: 10.7x ↑ Serie 99.0 Total 99.0
2. Serie Ligg		1: 9.9 ↓ 2: 10.7x ↑ 3: 10.7x ↓ 4: 10.0 ↗ 5: 10.4 ↓	Prøve
		Serie 49.0 Total 148.0	 1: 9.9 → 2: 10.7x → 3: 10.1 ↑ 4: 10.6x → 5: 10.5x → 6: 10.7x → Serie 59.0 Total 148.0
3. Serie Ligg		1: 10.4x ↓ 2: 10.7x ↗ 3: 10.1 ↓ 4: 10.4 → 5: 9.9 ↘	4. Serie Ligg
		Serie 49.0 Total 197.0	 1: 10.5x ↑ 2: 10.3 ↑ 3: 10.6x ↖ 4: 10.1 ↓ 5: 10.7x ↖ Serie 50.0 Total 247.0
5. Serie Ligg		1: 10.9x → 2: 10.3 ↖ 3: 10.7x ↓ 4: 10.3 ↘ 5: 10.0 ↘	
		Serie 50.0 Total 297.0	

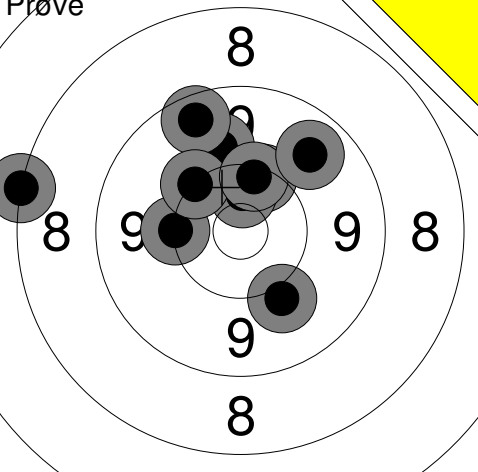
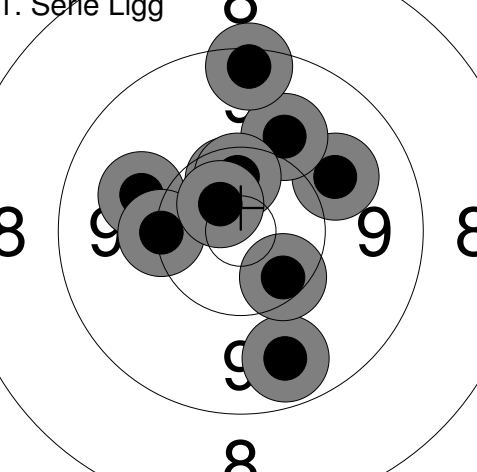
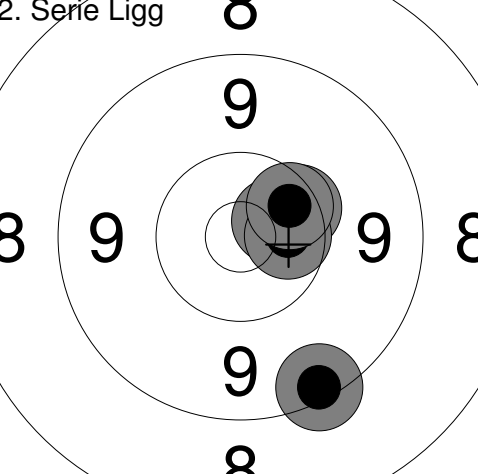
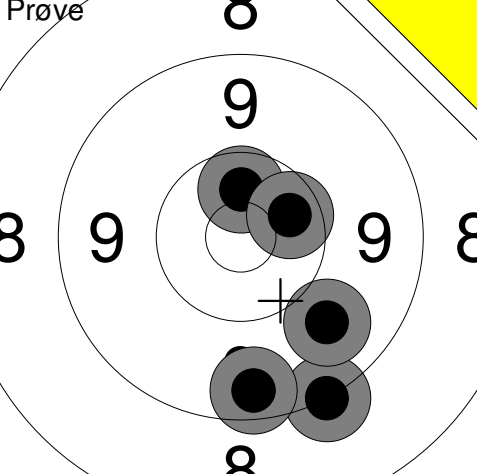
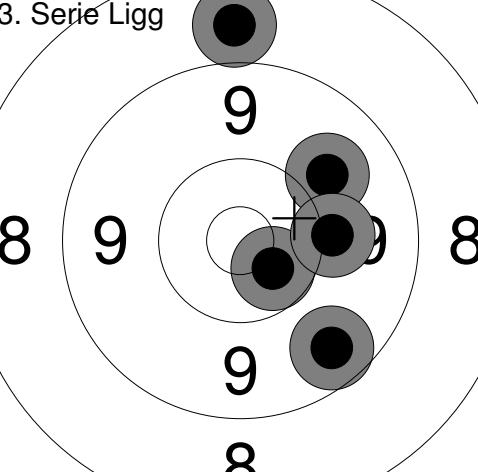
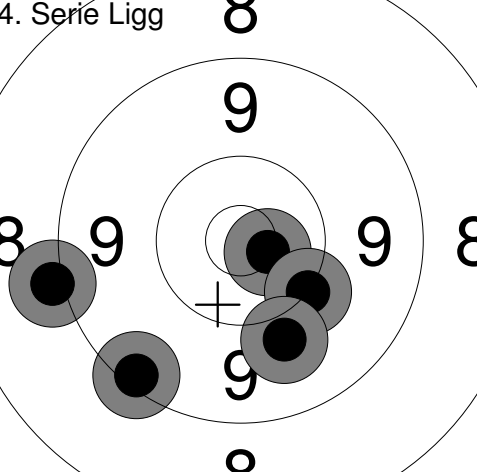
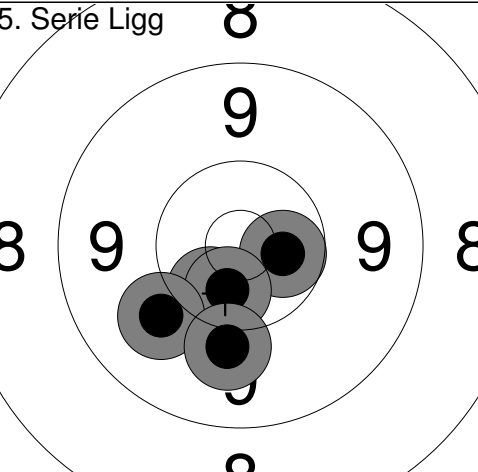

<p>Prøve</p> 	<p>1: 8.2 ←</p> <p>2: 10.2 ←</p> <p>3: 9.9 ↗</p> <p>4: 10.3 ↗</p> <p>5: 9.5 ↗</p> <p>6: 10.5x ↗</p> <p>7: 10.2 ↗</p> <p>8: 10.3 ↗</p> <p>9: 9.7 ↗</p> <p>10: 10.0 ↘</p> <hr/> <p>Serie 95.0</p> <hr/> <p>Total 0.0</p>	<p>1. Serie Ligg</p> 	<p>1: 10.5x ↑</p> <p>2: 9.9 ↗</p> <p>3: 9.7 ↘</p> <p>4: 10.0 ←</p> <p>5: 10.4 ↘</p> <p>6: 10.0 ↗</p> <p>7: 9.4 ↑</p> <p>8: 10.2 ←</p> <p>9: 10.4x ↑</p> <p>10: 10.6x ↗</p> <hr/> <p>Serie 97.0</p> <hr/> <p>Total 97.0</p>
<p>2. Serie Ligg</p> 	<p>1: 10.4 ↗</p> <p>2: 10.6x ↗</p> <p>3: 9.3 ↘</p> <p>4: 10.5x →</p> <p>5: 10.4 ↗</p> <hr/> <p>Serie 49.0</p> <hr/> <p>Total 146.0</p>	<p>Prøve</p> 	<p>1: 9.2 ↘</p> <p>2: 9.8 ↘</p> <p>3: 9.5 ↘</p> <p>4: 10.5x ↑</p> <p>5: 10.4x ↗</p> <hr/> <p>Serie 47.0</p> <hr/> <p>Total 146.0</p>
<p>3. Serie Ligg</p> 	<p>1: 9.9 ↗</p> <p>2: 8.8 ↑</p> <p>3: 9.6 ↘</p> <p>4: 10.5x ↘</p> <p>5: 10.1 →</p> <hr/> <p>Serie 46.0</p> <hr/> <p>Total 192.0</p>	<p>4. Serie Ligg</p> 	<p>1: 9.3 ↘</p> <p>2: 10.7x →</p> <p>3: 10.2 ↘</p> <p>4: 9.1 ←</p> <p>5: 9.9 ↘</p> <hr/> <p>Serie 47.0</p> <hr/> <p>Total 239.0</p>
<p>5. Serie Ligg</p> 	<p>1: 10.4x ↘</p> <p>2: 10.5x →</p> <p>3: 10.5x ↘</p> <p>4: 10.0 ↘</p> <p>5: 10.0 ↘</p> <hr/> <p>Serie 50.0</p> <hr/> <p>Total 289.0</p>		

Hold	Skive	Louise Christiansen	
562	18	50 meter afsnit 2	Glud Skytteforening
		Landsstævne 2017	Aalborg Skyttekreds
Prøve		1: 9.2 ↗ 2: 9.4 → 3: 9.6 ↘ 4: 10.4 ↗ 5: 9.7 ↗ 6: 10.3 ↘ 7: 10.7x ↗ 8: 10.2 ↘	1. Serie Ligg
		Serie 76.0	1: 9.8 ↘ 2: 10.3 ↑ 3: 10.2 ↘ 4: 10.6x ↘ 5: 9.5 ↘ 6: 10.5x ↑ 7: 10.6x ↗ 8: 10.5x ← 9: 9.9 ← 10: 10.2 ↘
		Total 0.0	Serie 97.0
			Total 97.0
2. Serie Ligg		1: 10.7x ↑ 2: 10.2 ↗ 3: 10.2 → 4: 10.2 ↑ 5: 10.6x ←	Prøve
		Serie 50.0	1: 9.9 ↗ 2: 10.3 ↘ 3: 10.1 ↘ 4: 10.4x ↗ 5: 10.0 ↗ 6: 10.1 ↑ 7: 10.7x ←
		Total 147.0	Serie 69.0
			Total 147.0
3. Serie Ligg		1: 10.6x ↘ 2: 9.9 ↑ 3: 10.8x ↘ 4: 10.1 ↘ 5: 10.2 ↘	4. Serie Ligg
		Serie 49.0	1: 10.3 → 2: 9.8 ↑ 3: 10.0 ↑ 4: 10.2 → 5: 10.8x ↘
		Total 196.0	Serie 49.0
			Total 245.0
5. Serie Ligg		1: 10.1 ↘ 2: 10.6x → 3: 10.4 ↑ 4: 10.0 ↘ 5: 10.1 →	
		Serie 50.0	
		Total 295.0	

Hold	Skive	Jens Roland Jensen	
562	19		
50 meter afsnit 2		Midtdjurs Skytteforening	
		LIG	
		Landsstævne 2017	Aalborg Skyttekreds
Prøve		1: 9.8 ↓ 2: 10.5x ↓ 3: 9.9 ↗ 4: 8.5 ↗ 5: 10.6x ← 6: 10.3 ↓ 7: 10.2 ↗ 8: 9.5 → 9: 9.3 ↗ 10: 10.1 ←	1. Serie Ligg
		1: 10.8x ← 2: 9.1 ← 3: 9.5 ↓ 4: 9.8 → 5: 10.1 ↗ 6: 10.5x ↓ 7: 9.8 ↓ 8: 10.4 ↓ 9: 10.7x ↓ 10: 10.7x ←	
		Serie 94.0	Serie 96.0
		Total 0.0	Total 96.0
2. Serie Ligg		1: 9.7 ↓ 2: 10.6x ↓ 3: 10.6x → 4: 10.8x ↓ 5: 10.7x ↑	Prøve
		1: 10.2 ↓ 2: 10.0 ← 3: 10.9x ← 4: 10.0 ← 5: 10.4x ↑	
		Serie 49.0	Serie 50.0
		Total 145.0	Total 145.0
3. Serie Ligg		1: 10.7x ↑ 2: 10.4 ↑ 3: 10.2 ↗ 4: 10.5x ← 5: 10.3 ↑	4. Serie Ligg
		1: 10.6x ↑ 2: 10.5x ← 3: 10.1 ← 4: 10.2 → 5: 10.1 ↓	
		Serie 50.0	Serie 50.0
		Total 195.0	Total 245.0
5. Serie Ligg		1: 10.8x ↓ 2: 10.7x → 3: 10.4x ↗ 4: 10.8x ↓ 5: 10.5x →	
		Serie 50.0	
		Total 295.0	

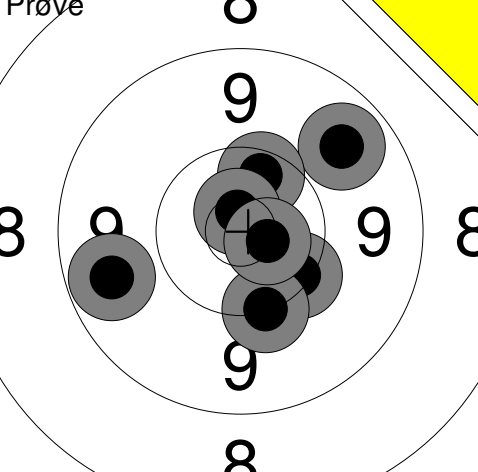
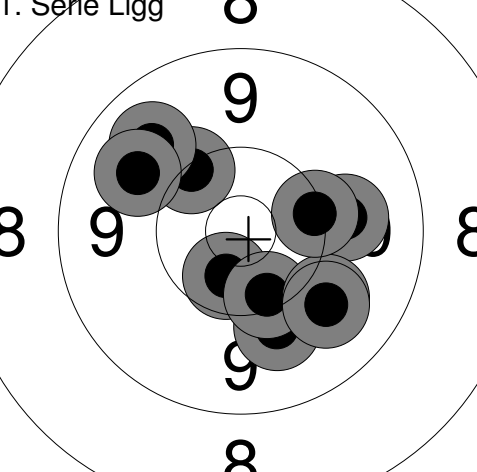
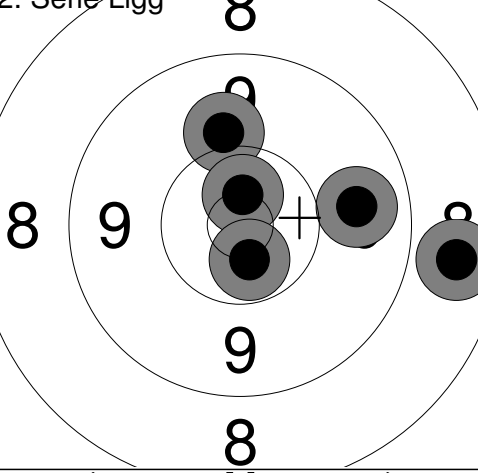
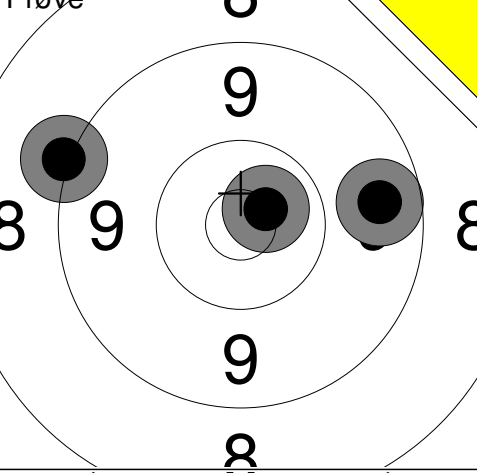
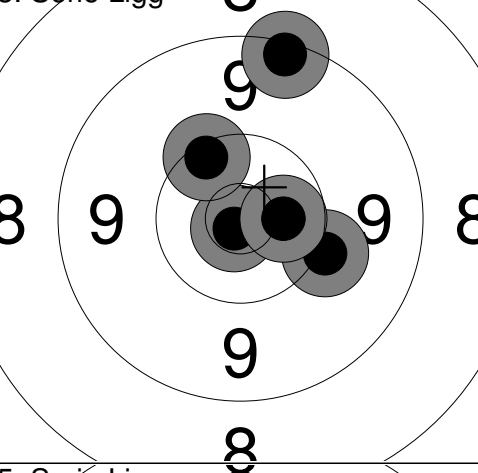
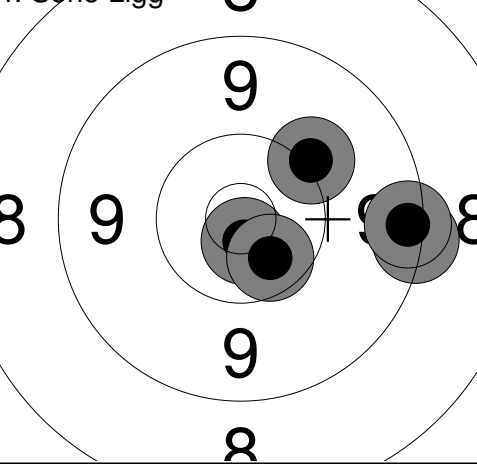
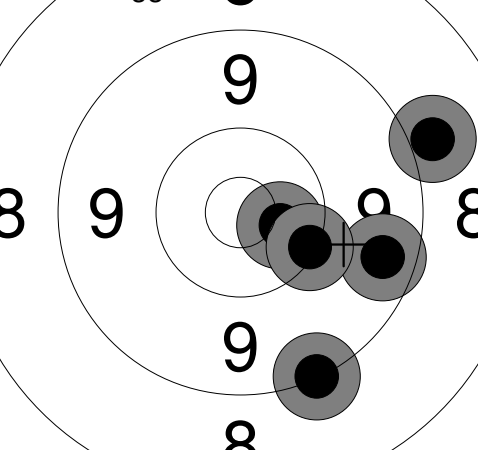
Prøve 	1: 9.6 ← 2: 9.7 ↗ 3: 10.3 ↘ 4: 10.4 ↗ 5: 10.2 ↘ 6: 10.8x ↗ 7: 10.7x ↘ <hr/> Serie 68.0 Total 0.0	1. Serie Ligg 	1: 10.2 ↗ 2: 10.0 ↘ 3: 10.5x ↘ 4: 10.0 → 5: 10.3 ↘ 6: 9.9 ↘ 7: 9.9 ↘ 8: 9.8 ↗ 9: 9.8 ↗ 10: 10.2 → <hr/> Serie 96.0 Total 96.0
2. Serie Ligg 	1: 10.0 ↗ 2: 10.7x ↗ 3: 9.8 → 4: 10.6x ↘ 5: 8.7 → <hr/> Serie 47.0 Total 143.0	Prøve 	1: 9.1 ← 2: 9.6 → 3: 10.7x ↗ <hr/> Serie 28.0 Total 143.0
3. Serie Ligg 	1: 10.8x ↘ 2: 10.3 ↗ 3: 10.1 ↘ 4: 9.3 ↗ 5: 10.5x → <hr/> Serie 49.0 Total 192.0	4. Serie Ligg 	1: 9.3 → 2: 10.7x ↘ 3: 9.3 → 4: 10.1 ↗ 5: 10.5x ↘ <hr/> Serie 48.0 Total 240.0
5. Serie Ligg 	1: 10.6x → 2: 9.2 ↘ 3: 9.5 ↘ 4: 10.2 ↘ 5: 8.9 → <hr/> Serie 46.0 Total 286.0		

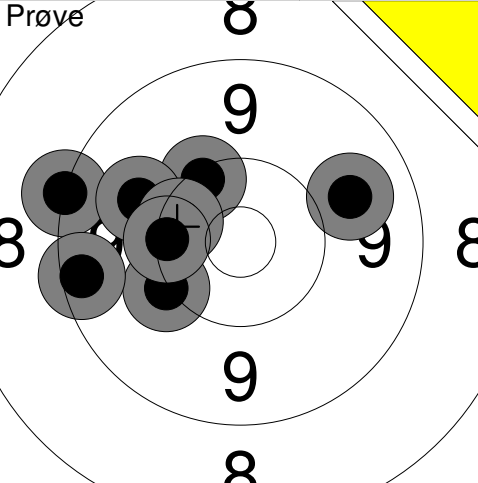
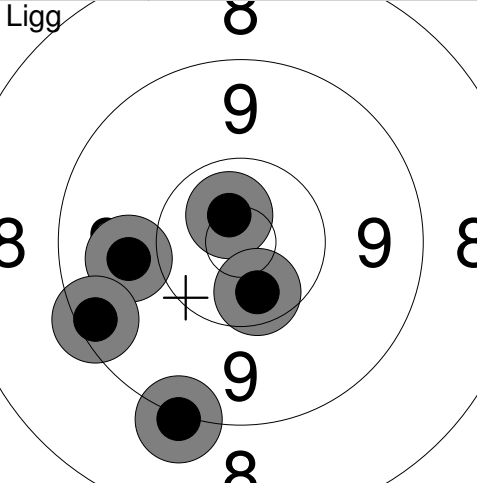
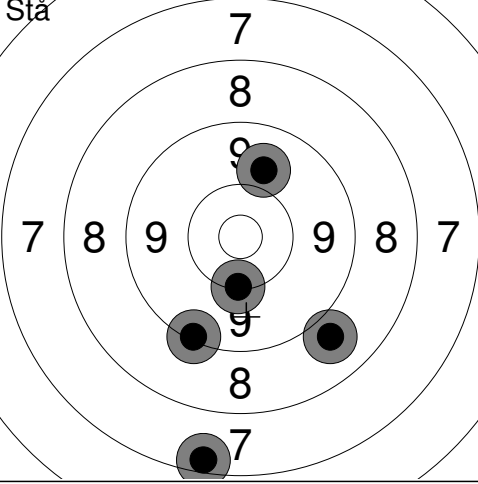
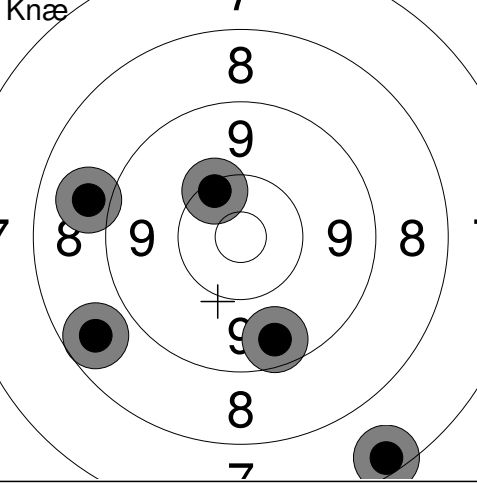
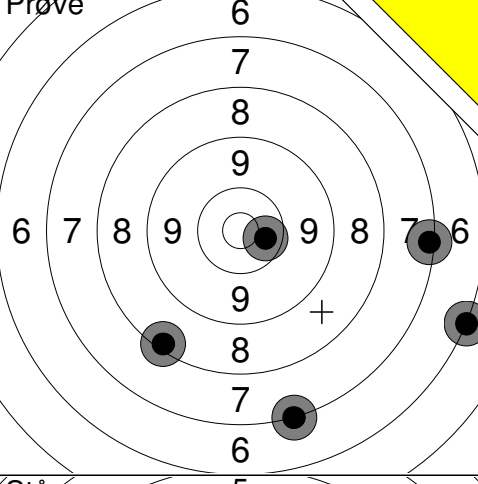
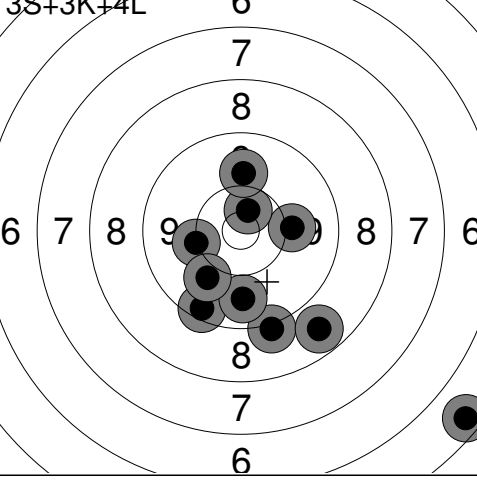
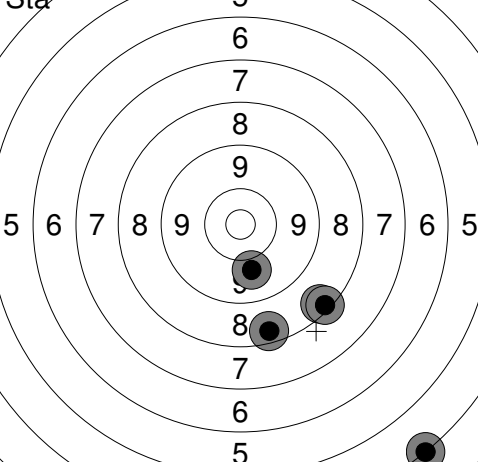
Hold	Skive	Palle Henriksen			
563	13				
50 meter afsnit 2		Tingsted Skytteforening	SEN		
Landsstævne 2017		Aalborg Skyttekreds			
Prøve		1: 9.2 ← 2: 10.3 ↗ 3: 10.3 ↗ 4: 10.3 ↗ 5: 10.1 ↖ 6: 9.4 ↖ 7: 9.9 ↗ 8: 10.4 ↖ 9: 10.3 ↖ 10: 9.8 →	Ligg		1: 9.9 ← 2: 10.7x ↗ 3: 9.1 ↘ 4: 10.5x ↘ 5: 9.4 ↖
		Serie 96.0		Serie 47.0	
		Total 0.0		Total 47.0	
Stå		1: 10.2 ↓ 2: 9.9 ↗ 3: 8.9 ↘ 4: 7.4 ↘ 5: 9.2 ↘	Knæ		1: 10.3 ↗ 2: 8.6 ↖ 3: 7.4 ↘ 4: 8.9 ↖ 5: 9.5 ↘
		Serie 43.0		Serie 42.0	
		Total 90.0		Total 132.0	
Prøve		1: 10.5x → 2: 7.2 ↘ 3: 8.3 ↘ 4: 6.2 ↘ 5: 7.3 →	3S+3K+4L		1: 10.1 → 2: 10.6x ↗ 3: 5.5 ↘ 4: 10.1 ← 5: 9.1 ↘ 6: 9.4 ↘ 7: 9.7 ↘ 8: 9.9 ↘ 9: 9.9 ↑ 10: 8.6 ↘
		Serie 38.0		Serie 88.0	
		Total 132.0		Total 220.0	
Stå		1: 4.2 ↘ 2: 9.9 ↘ 3: 8.5 ↘ 4: 8.4 ↘ 5: 8.3 ↘			
		Serie 37.0			
		Total 257.0			

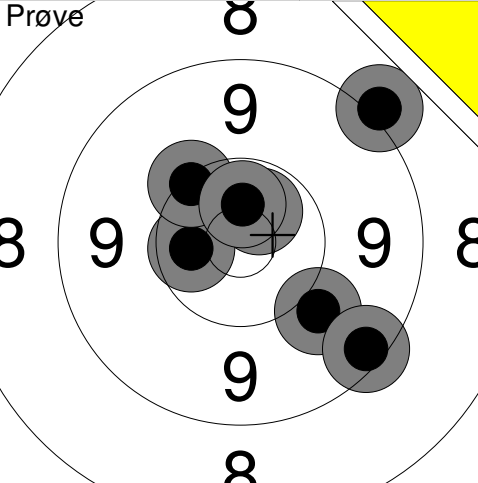
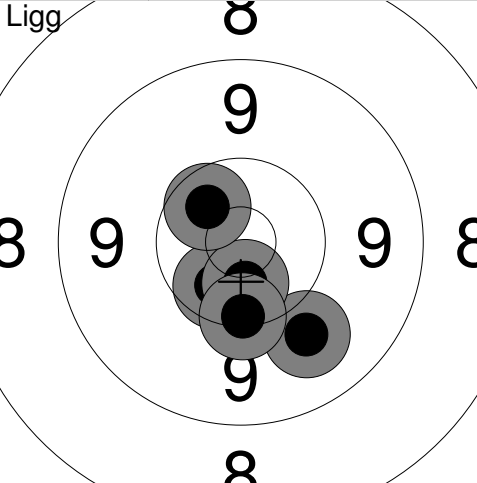
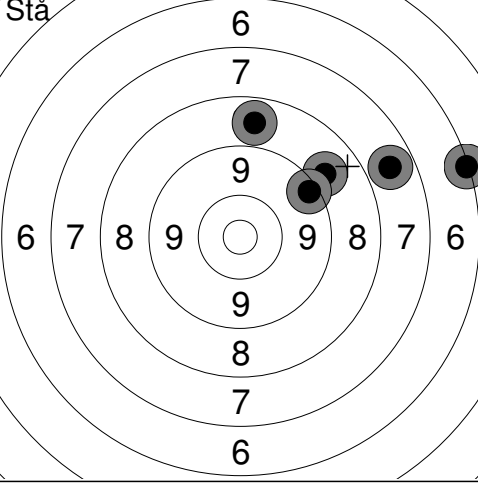
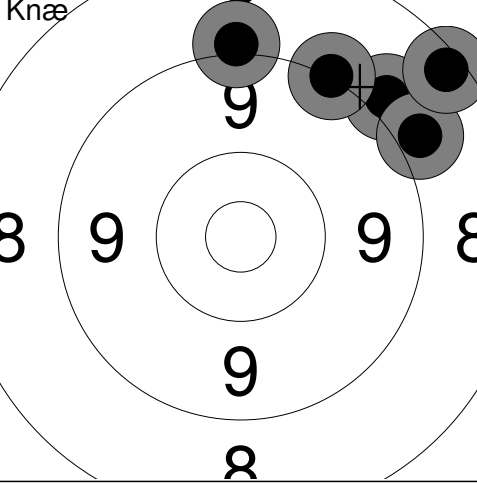
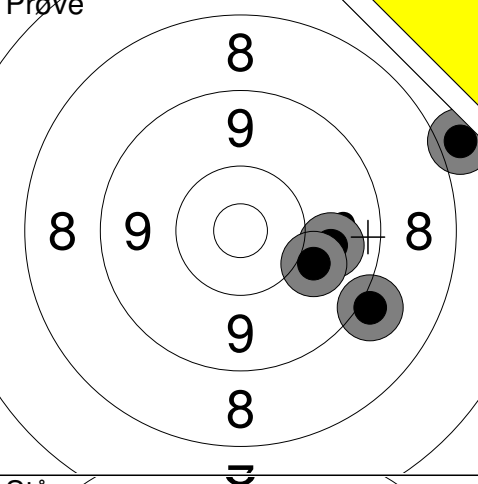
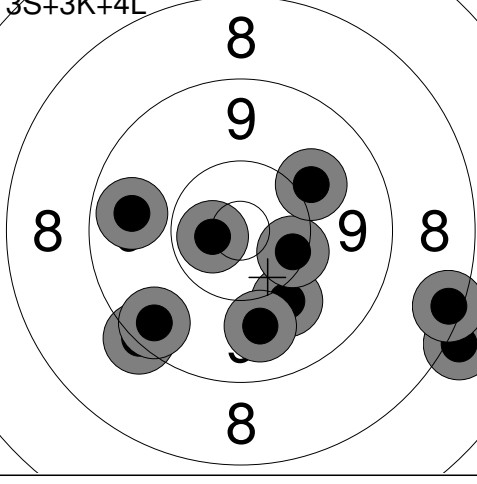
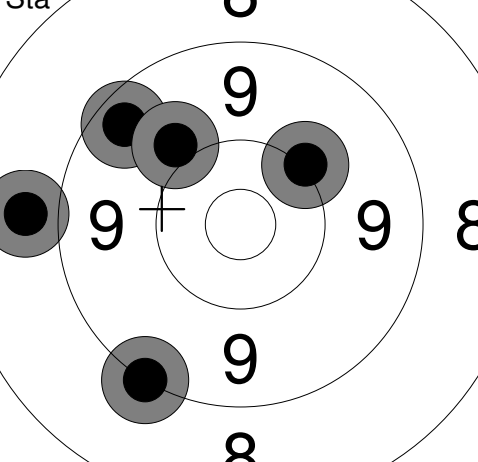
Hold	Skive	Mikael Green	
563	14		
50 meter afsnit 2		Tingsted Skytteforening	SEN
Landsstævne 2017		Aalborg Skyttekreds	
Prøve		1: 10.6x ↗ 2: 10.0 ↘ 3: 10.5x ← 4: 10.2 ↗ 5: 9.4 ↘ 6: 9.1 ↗ 7: 10.6x ↑	Ligg
		Serie 68.0 Total 0.0	 1: 10.5x ↘ 2: 9.9 ↘ 3: 10.6x ↘ 4: 10.3 ↘ 5: 10.5x ↗
		Serie 49.0 Total 49.0	
Stå		1: 6.2 → 2: 7.7 → 3: 8.9 → 4: 8.7 ↑ 5: 9.3 →	Knæ
		Serie 38.0 Total 87.0	 1: 9.0 ↗ 2: 9.2 ↗ 3: 8.9 → 4: 9.1 ↑ 5: 8.3 ↗
		Serie 43.0 Total 130.0	
Prøve		1: 9.0 ↘ 2: 7.9 → 3: 9.8 ↘ 4: 10.0 ↘	3S+3K+4L
		Serie 35.0 Total 130.0	 1: 8.0 ↘ 2: 10.0 ↘ 3: 8.3 ↘ 4: 10.3 → 5: 10.0 ↗ 6: 10.6x ← 7: 9.2 ↘ 8: 9.8 ↘ 9: 9.5 ↘ 10: 9.7 ←
		Serie 92.0 Total 222.0	
Stå		1: 9.2 ↘ 2: 8.9 ← 3: 9.5 ↗ 4: 10.1 ↗ 5: 10.0 ↗	
		Serie 46.0 Total 268.0	

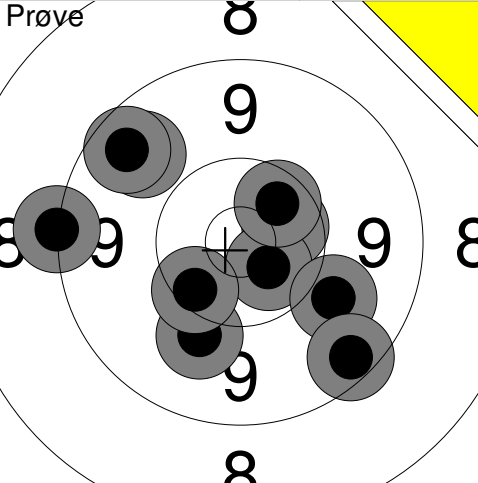
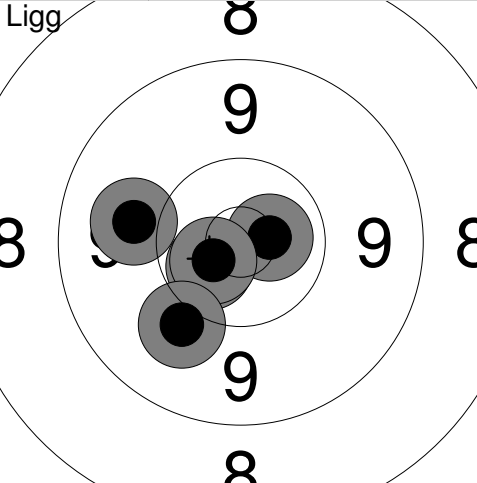
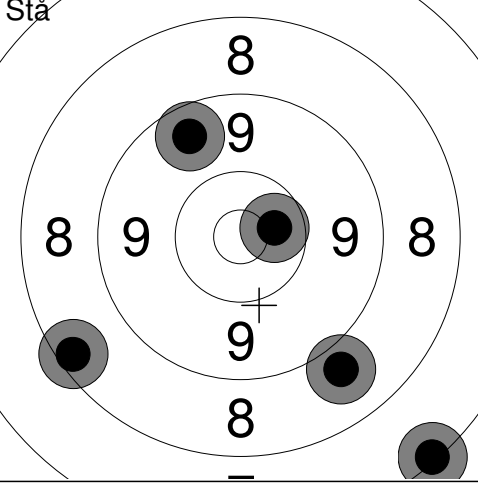
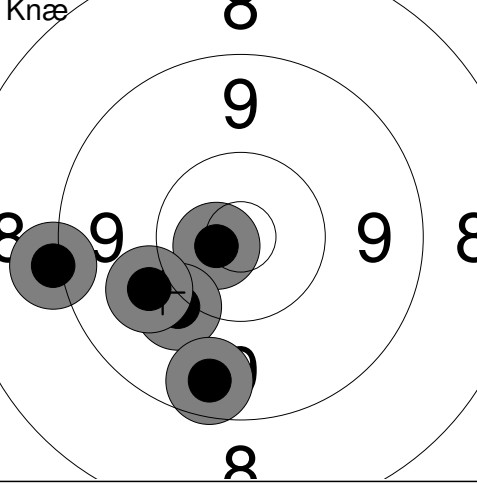
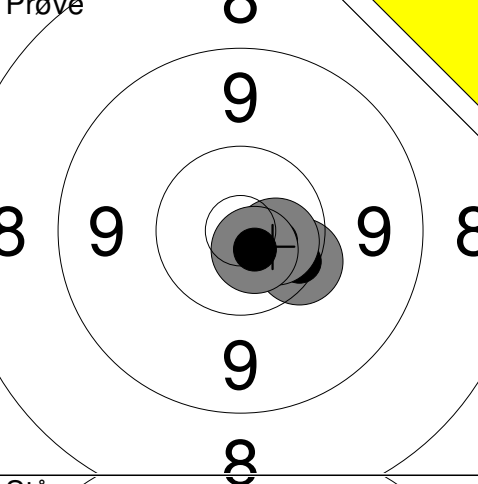
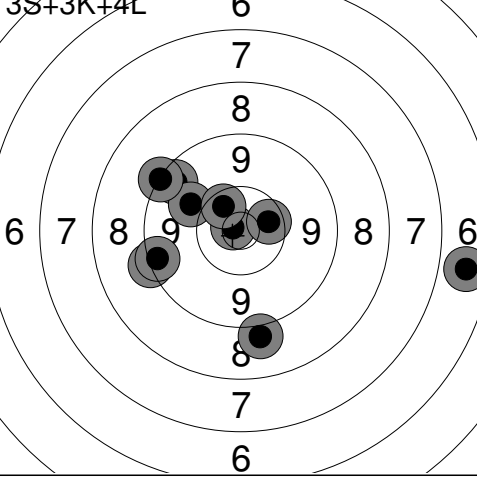
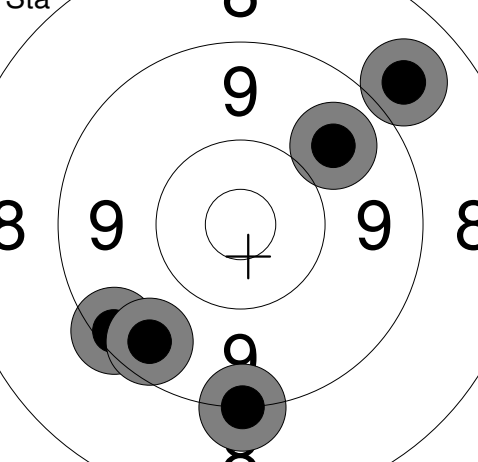
Hold	Skive	Anders Hansen			
563	15				
50 meter afsnit 2		Horne Skytteforening			
		SEN			
		Landsstævne 2017			
		Aalborg Skyttekreds			
Prøve		1: 9.2 ← 2: 10.5x → 3: 10.6x ↘ 4: 9.9 ↘ 5: 10.5x → 6: 9.7 ↗ 7: 10.0 ↘ 8: 9.4 ↘ 9: 9.6 ↗ 10: 10.3 ↘ Serie 95.0 Total 0.0	Ligg		1: 10.7x → 2: 10.6x ↘ 3: 10.6x ↘ 4: 10.0 ↘ 5: 9.9 ← Serie 49.0 Total 49.0
Stå		1: 8.4 ← 2: 8.9 ↘ 3: 10.5x → 4: 7.2 ↘ 5: 9.6 ↗ Serie 42.0 Total 91.0	Knæ		1: 10.7x ← 2: 10.1 ↘ 3: 9.5 ↘ 4: 9.1 ← 5: 10.0 ↘ Serie 48.0 Total 139.0
Prøve		1: 10.3 ↘ 2: 10.6x → 3: 10.7x ↘ Serie 30.0 Total 139.0	3S+3K+4L		1: 6.6 → 2: 10.8x ↗ 3: 9.0 ↘ 4: 9.5 ↗ 5: 9.2 ← 6: 9.9 ↗ 7: 9.2 ↗ 8: 10.4x ↗ 9: 10.4x → 10: 9.3 ← Serie 90.0 Total 229.0
Stå		1: 8.8 ↗ 2: 9.4 ↘ 3: 9.2 ↘ 4: 9.5 ↘ 5: 9.8 ↗ Serie 44.0 Total 273.0			

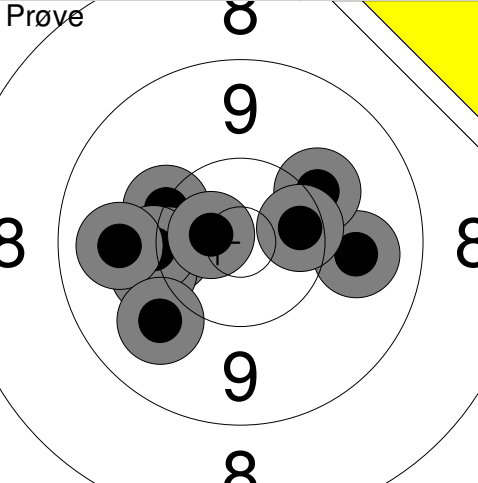
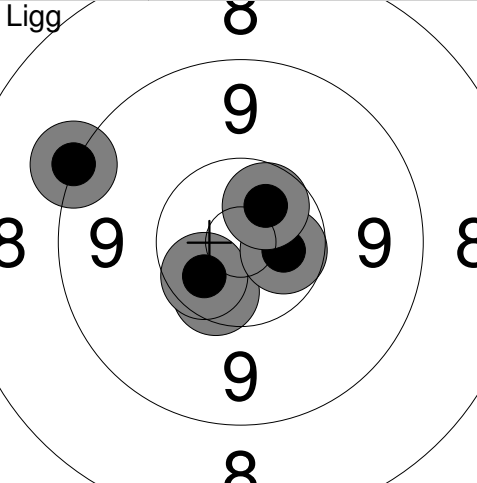
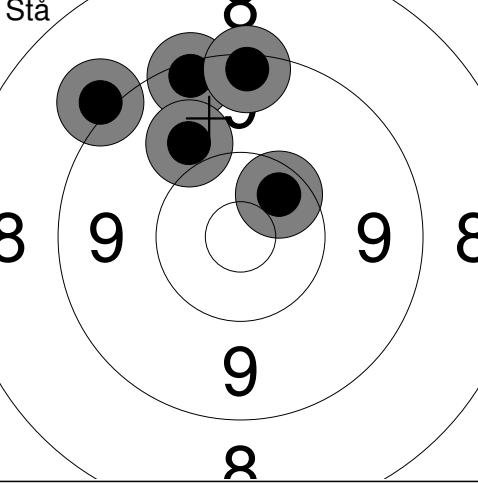
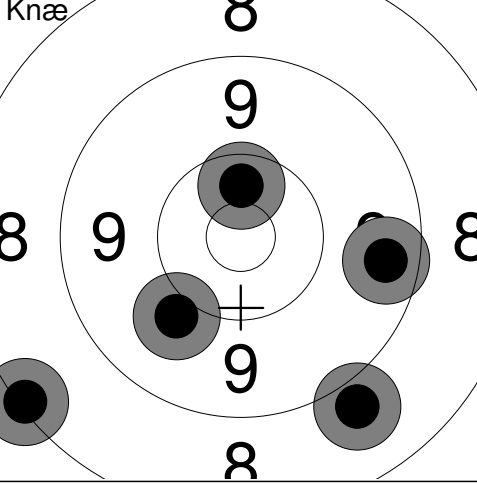
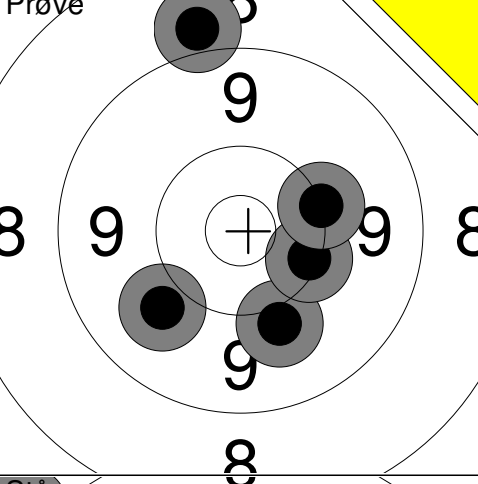
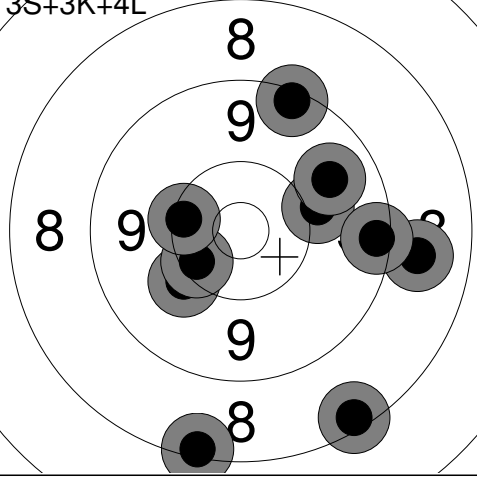
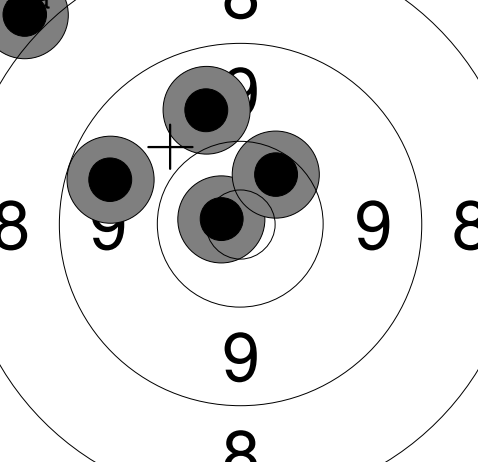
Hold	Skive	Betina Petersen			
563	16				
50 meter afsnit 2		Tingsted Skytteforening	SEN		
Landsstævne 2017		Aalborg Skyttekreds			
Prøve		1: 10.2 ↖ 2: 10.3 ← 3: 10.1 ← 4: 9.8 → 5: 10.1 ← 6: 10.1 → 7: 10.7x ← 8: 10.4 → 9: 9.8 ← 10: 9.9 ↙ Serie 97.0 Total 0.0	Ligg		1: 10.4x ↙ 2: 10.5x ↙ 3: 10.5x → 4: 10.5x ↗ 5: 9.2 ← Serie 49.0 Total 49.0
Stå		1: 9.3 ↗ 2: 9.1 ↗ 3: 9.3 ↗ 4: 9.9 ↗ 5: 10.4 ↗ Serie 46.0 Total 95.0	Knæ		1: 8.2 ↙ 2: 9.5 → 3: 10.5x ↑ 4: 8.9 ↘ 5: 10.0 ↘ Serie 45.0 Total 140.0
Prøve		1: 9.9 ↙ 2: 10.0 ↘ 3: 10.3 ↘ 4: 10.2 → 5: 8.9 ↑ Serie 47.0 Total 140.0	3S+3K+4L		1: 10.1 ↙ 2: 10.3 ↙ 3: 9.3 ↑ 4: 8.3 ↘ 5: 10.0 → 6: 8.3 ↘ 7: 9.8 → 8: 8.8 → 9: 9.3 → 10: 10.3 ← Serie 91.0 Total 231.0
Prøve		1: 8.0 ↗ 2: 9.6 ↗ 3: 9.8 ↗ 4: 10.8x ← 5: 10.4 ↗ Serie 46.0 Total 277.0			

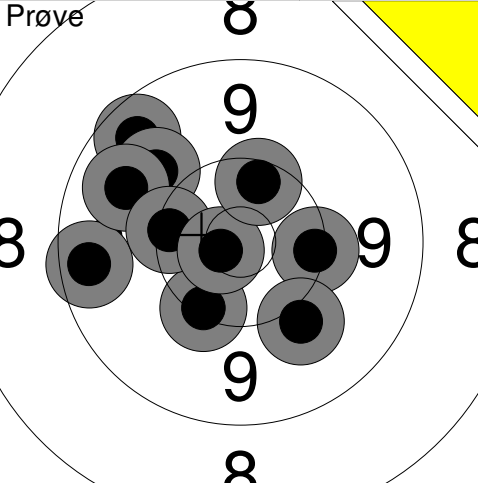
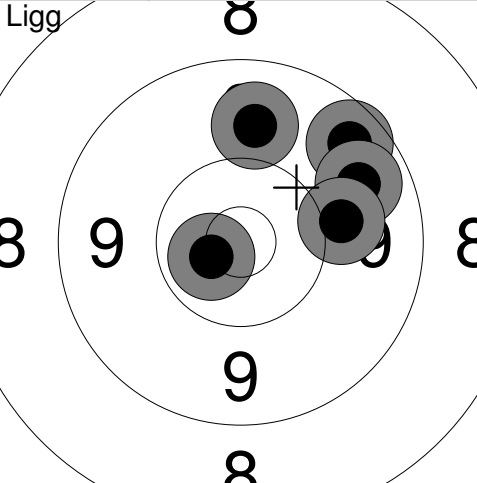
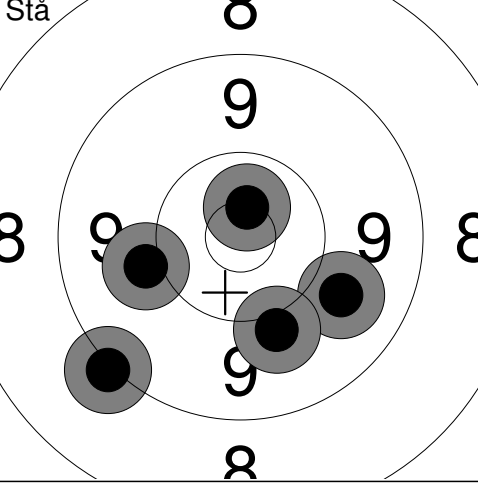
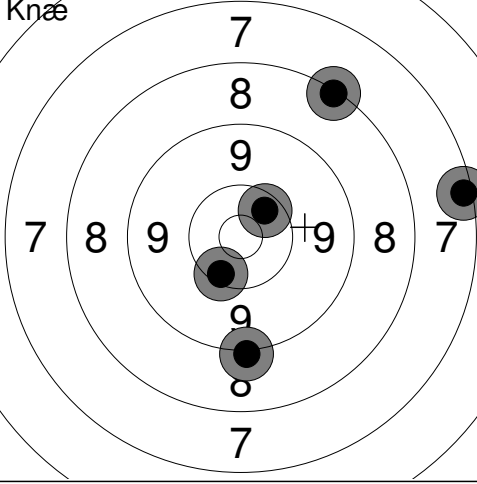
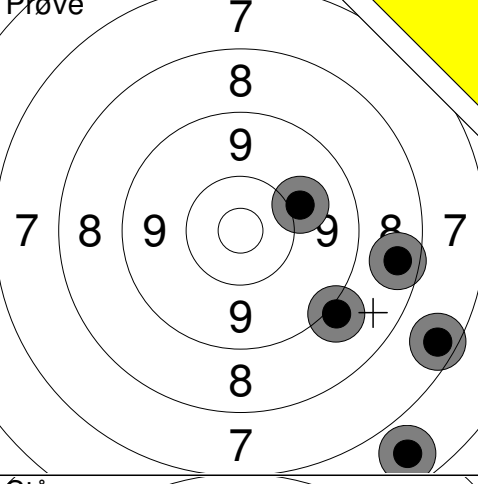
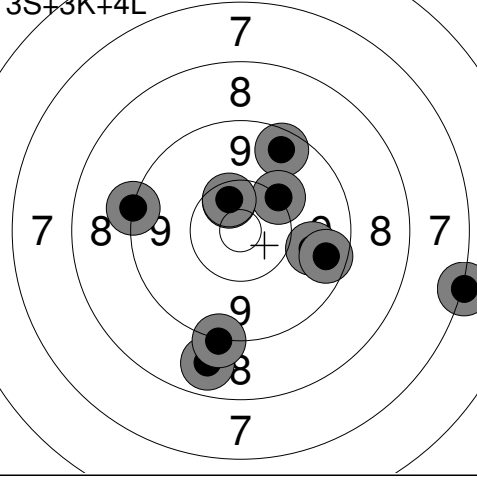
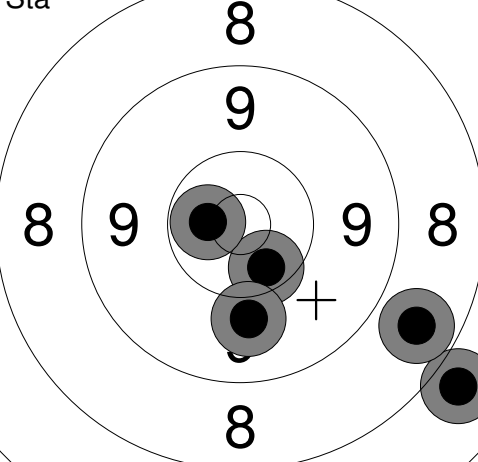

Hold	Skive	Birthe Holm Thomsen			
563	17	Ornebjerg Skytteforening	SEN		
50 meter afsnit 2	Landsstævne 2017	Aalborg Skyttekreds			
Prøve		1: 9.5 ↗ 2: 9.5 ← 3: 9.9 ↗ 4: 10.2 ↓ 5: 9.7 ↗ 6: 10.3 ← 7: 10.2 → 8: 10.0 ↓ 9: 10.8x ← 10: 10.4 ↑ Serie 96.0 Total 0.0	Ligg		1: 9.8 ↑ 2: 9.5 ↗ 3: 9.7 → 4: 10.0 → 5: 10.6x ← Serie 47.0 Total 47.0
Stå		1: 9.1 ↓ 2: 10.0 ← 3: 10.7x ↑ 4: 9.9 ↓ 5: 10.0 ↓ Serie 48.0 Total 95.0	Knæ		1: 10.4 ↗ 2: 9.1 ↓ 3: 8.2 ↗ 4: 7.3 → 5: 10.3 ↓ Serie 44.0 Total 139.0
Prøve		1: 9.0 ↓ 2: 8.5 → 3: 6.7 ↓ 4: 10.0 → 5: 7.5 ↓ Serie 40.0 Total 139.0	3S+3K+4L		1: 8.7 ↓ 2: 10.5x ↑ 3: 7.1 → 4: 9.8 → 5: 9.1 ↓ 6: 9.2 ← 7: 9.5 ↑ 8: 10.2 ↗ 9: 10.4x ↑ 10: 9.5 → Serie 90.0 Total 229.0
Stå		1: 7.9 ↓ 2: 10.4 ↓ 3: 9.9 ↓ 4: 10.6x ← 5: 8.7 ↓ Serie 44.0 Total 273.0			

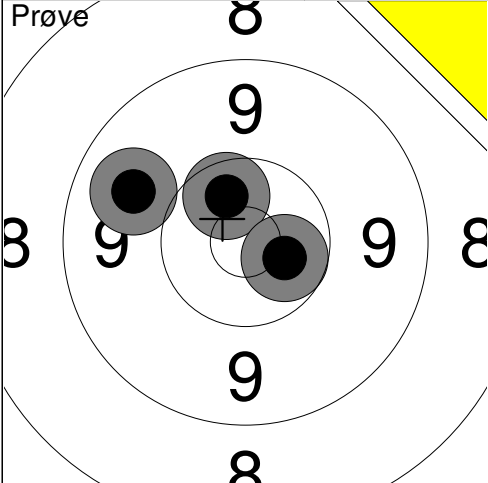
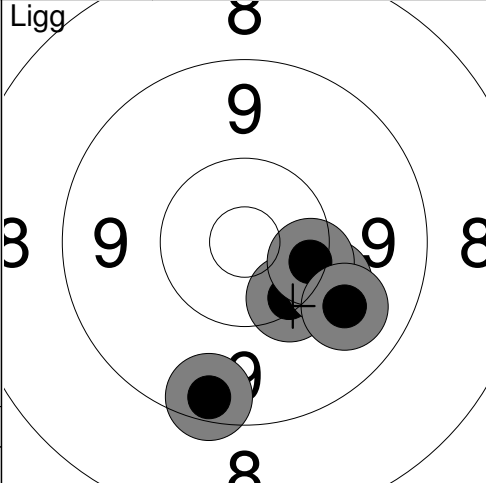
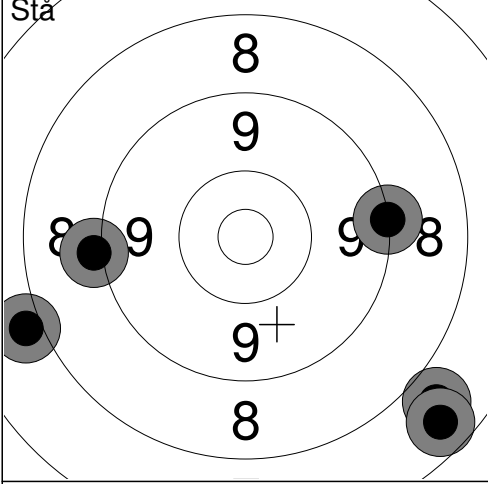
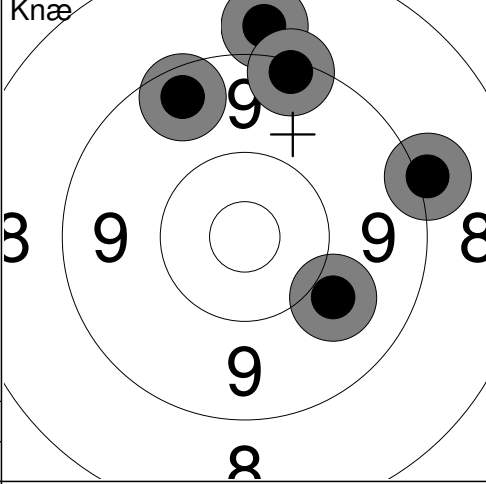
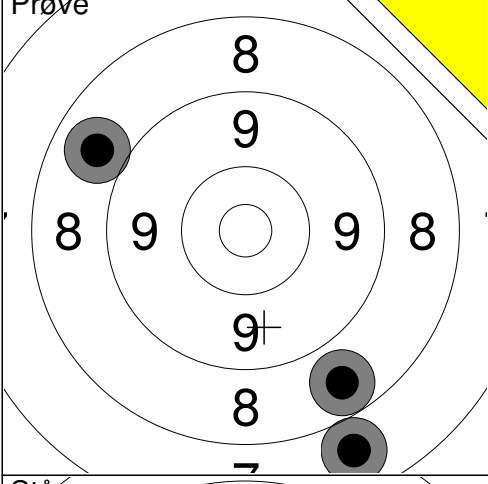
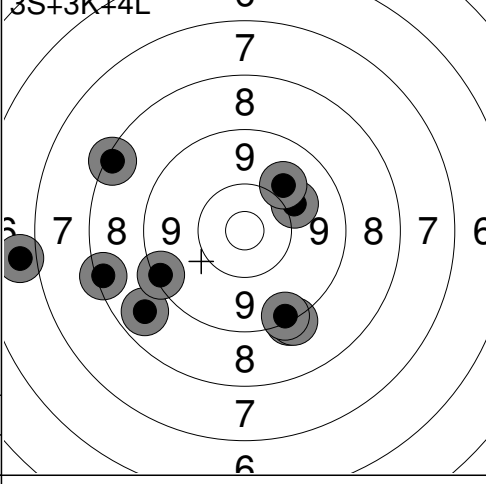
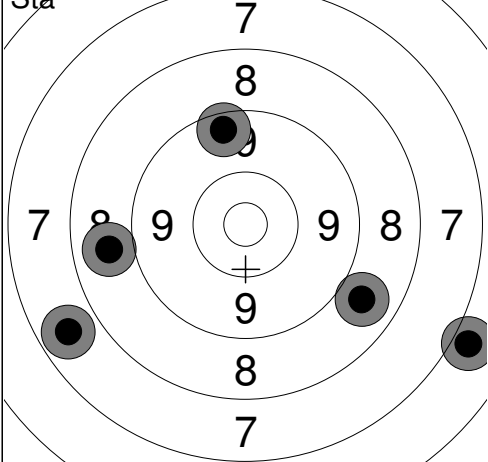
Hold	Skive	Palle Holm	
563	18		
50 meter afsnit 2		Sjørring Skytteforening	
		SEN	
		Landsstævne 2017	
		Aalborg Skyttekreds	
Prøve		1: 10.5x ↗ 2: 10.6x ↘ 3: 9.8 ↗	Ligg
		Serie 29.0 Total 0.0	
			1: 9.4 ↓ 2: 10.3 ↓ 3: 10.1 ↓ 4: 10.3 → 5: 9.8 ↓
			Serie 48.0 Total 48.0
Stå		1: 7.8 ↓ 2: 8.0 ← 3: 9.2 → 4: 7.6 ↓ 5: 9.1 ←	Knæ
		Serie 40.0 Total 88.0	
			1: 9.1 → 2: 9.5 ↗ 3: 8.9 ↗ 4: 9.3 ↗ 5: 9.9 ↓
			Serie 44.0 Total 132.0
Prøve		1: 8.6 ↓ 2: 7.8 ↓ 3: 8.8 ↗	3S+3K+4L
		Serie 23.0 Total 132.0	
			1: 9.2 ↓ 2: 8.3 ↖ 3: 6.9 ← 4: 10.0 → 5: 8.7 ↖ 6: 9.9 ↗ 7: 9.1 ↓ 8: 9.3 ↓ 9: 8.3 ← 10: 9.3 ↖
			Serie 85.0 Total 217.0
Stå		1: 8.8 ↓ 2: 8.8 ← 3: 7.7 ↖ 4: 9.5 ↗ 5: 6.9 ↓	
		Serie 38.0 Total 255.0	

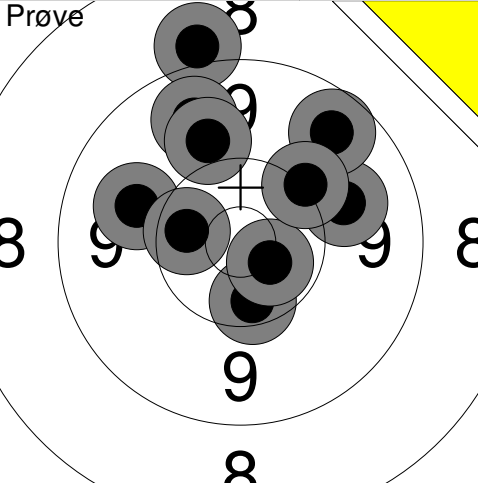
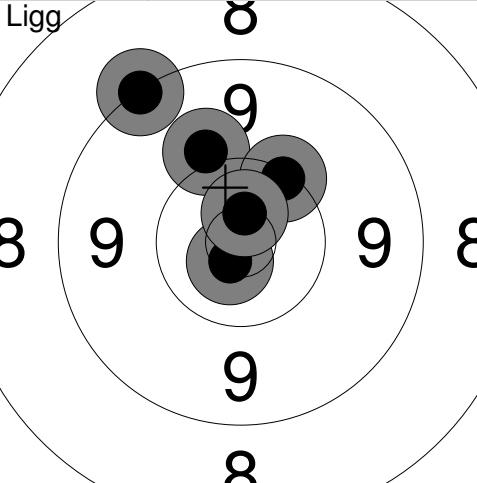
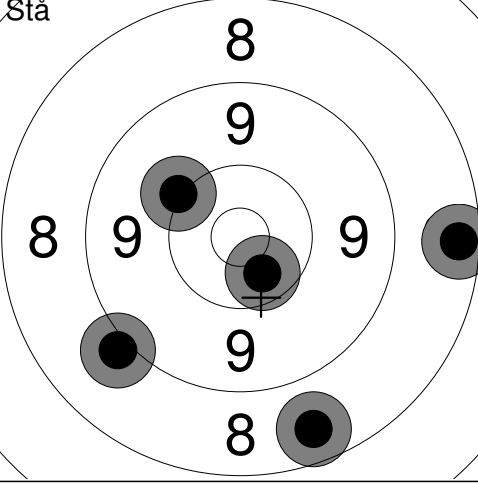
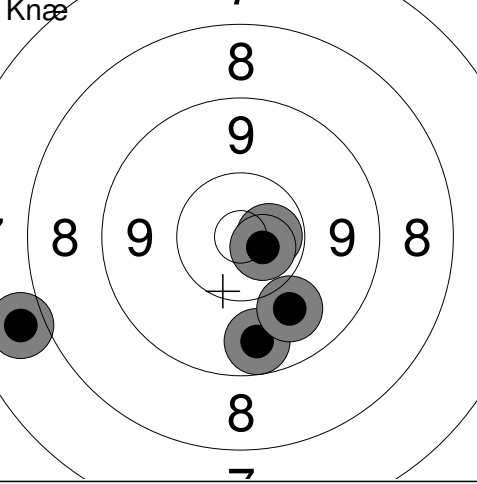
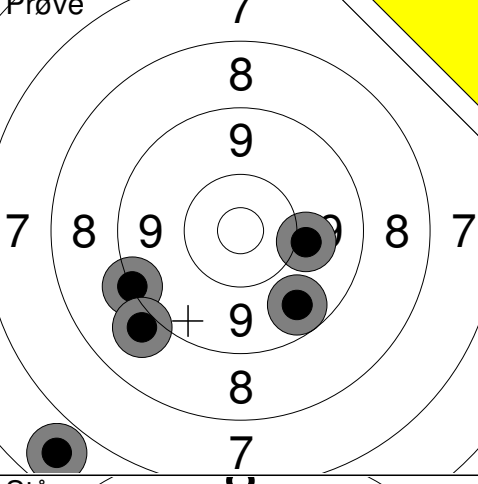
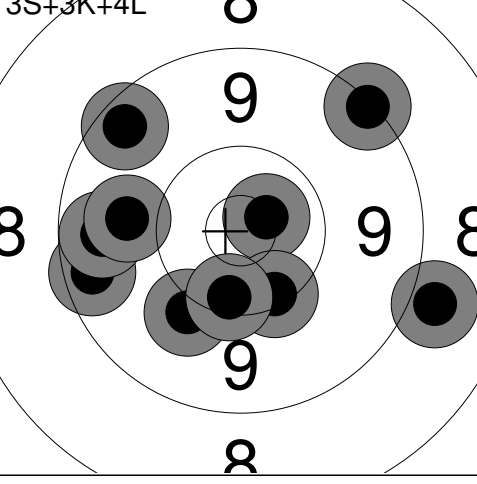
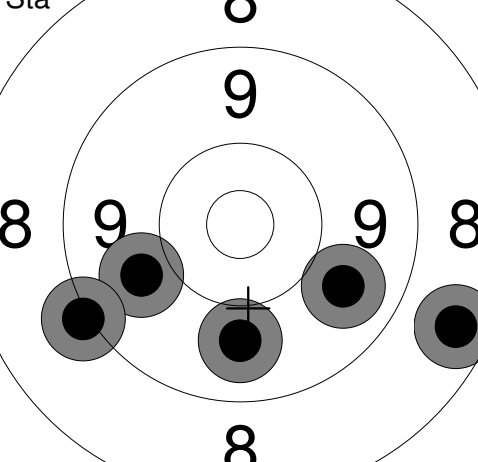
Hold	Skive	Nicolai Christensen	
563	19		
50 meter afsnit 2		Ribe Skyttekreds	SEN
Landsstævne 2017		Aalborg Skyttekreds	
<b>Prøve</b> 	1: 10.4 ↓ 2: 9.0 ↑ 3: 9.9 → 4: 9.6 ↗ 5: 10.6x ↘ 6: 9.7 ↗ 7: 10.0 ↗ 8: 9.9 ↖ 9: 10.4x ← 10: 10.1 ↗ Serie 95.0 Total 0.0	<b>Ligg</b> 	1: 10.0 ↑ 2: 9.2 ↖ 3: 10.2 ↗ 4: 10.7x ↓ 5: 10.7x ↑ Serie 49.0 Total 49.0
<b>Stå</b> 	1: 9.0 ← 2: 8.6 ↓ 3: 10.5x ↓ 4: 10.1 ↗ 5: 8.4 → Serie 45.0 Total 94.0	<b>Knæ</b> 	1: 10.6x → 2: 9.6 ↓ 3: 7.9 ← 4: 9.9 ↓ 5: 10.7x ↘ Serie 45.0 Total 139.0
<b>Prøve</b> 	1: 9.2 ← 2: 10.0 → 3: 9.6 ↓ 4: 9.0 ↓ 5: 6.7 ↙ Serie 43.0 Total 139.0	<b>3S+3K+4L</b> 	1: 10.7x ↗ 2: 8.9 → 3: 9.2 ↗ 4: 10.3 ↓ 5: 9.5 ← 6: 10.0 ↓ 7: 9.5 ↗ 8: 10.3 ↓ 9: 9.6 ← 10: 9.9 ← Serie 93.0 Total 232.0
<b>Stå</b> 	1: 9.9 ← 2: 9.8 ↓ 3: 9.1 ← 4: 9.8 ↓ 5: 8.5 ↘ Serie 44.0 Total 276.0		

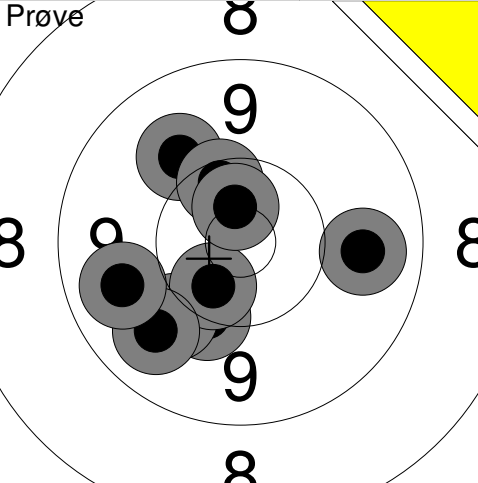
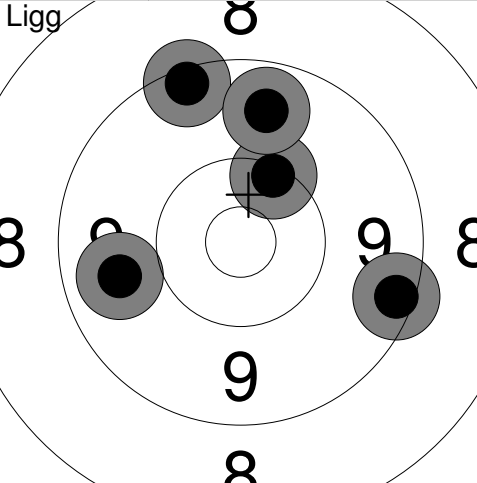
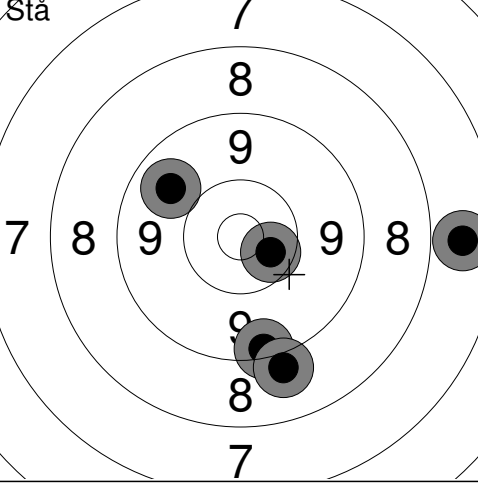
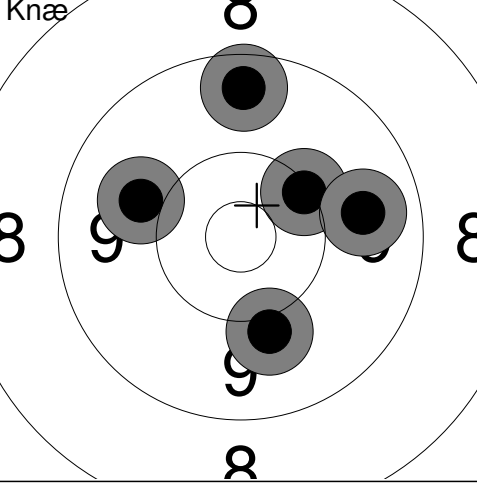
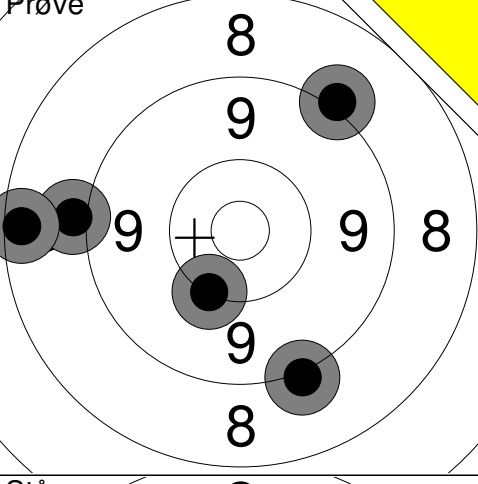
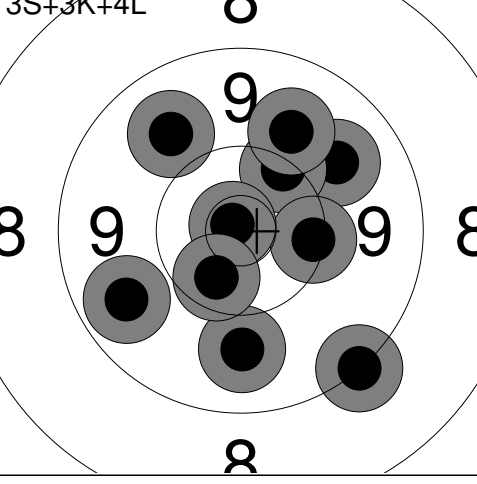
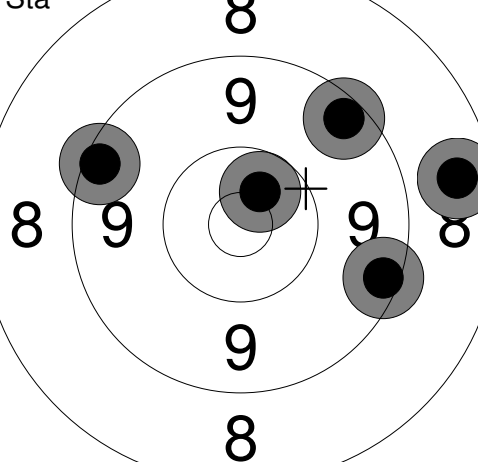
Hold	Skive	Lise Schäffer	
563	20		
50 meter afsnit 2		Sjørring Skytteforening	
		SEN	
		Landsstævne 2017	
		Aalborg Skyttekreds	
Prøve		1: 9.8 → 2: 10.2 ↓ 3: 10.0 ↓ 4: 10.0 ↑ 5: 10.5x ↓ 6: 9.8 ↓ 7: 9.8 ← 8: 10.4 ↑ 9: 10.6x ↑	Ligg
		Serie 87.0 Total 0.0	
			1: 9.3 ↑ 2: 10.3 ↑ 3: 9.7 ↑ 4: 9.8 ← 5: 9.4 →
			Serie 46.0 Total 46.0
Stå		1: 7.7 → 2: 9.3 ↓ 3: 9.0 ↓ 4: 9.8 ↑ 5: 10.5x ↓	Knæ
		Serie 44.0 Total 90.0	
			1: 10.0 ↓ 2: 10.2 ↗ 3: 9.5 ↑ 4: 9.8 → 5: 10.0 ←
			Serie 48.0 Total 138.0
Prøve		1: 9.1 ↓ 2: 9.0 ← 3: 9.1 ↗ 4: 10.2 ↓ 5: 8.4 ←	3S+3K+4L
		Serie 45.0 Total 138.0	
			1: 9.8 ↗ 2: 10.2 ↑ 3: 10.3 → 4: 9.8 ↓ 5: 9.7 ← 6: 9.2 ↓ 7: 10.9x ↗ 8: 9.9 ↑ 9: 10.5x ↓ 10: 9.8 ↑
			Serie 94.0 Total 232.0
Stå		1: 9.4 ↗ 2: 10.6x ↗ 3: 8.6 → 4: 9.3 ↗ 5: 9.3 ↓	
		Serie 45.0 Total 277.0	

Hold	Skive	Henrik Strand		
564	14	Viborg Skytteforening		
50 meter afsnit 2		SEN		
Landsstævne 2017		Aalborg Skyttekreds		
Prøve		1: 10.8x ← 2: 10.3 ← 3: 9.8 ↙ 4: 10.3 ↖ 5: 10.1 ↗ 6: 9.9 ↘ 7: 10.2 ↘ 8: 10.8x ↘ 9: 10.1 ↘	1. Serie Ligg	 1: 10.3 ↘ 2: 10.3 ↘ 3: 9.9 ↗ 4: 10.3 ↘ 5: 10.1 ↖
		Serie 88.0	Serie 49.0	
		Total 0.0	Total 49.0	
2. Serie Ligg		1: 10.7x ↙ 2: 9.9 ↘ 3: 10.5x ↘ 4: 10.1 ↗ 5: 10.2 ↗	Prøve	 1: 10.8x ↗ 2: 9.8 → 3: 10.0 → 4: 10.1 → 5: 9.1 →
		Serie 49.0	Serie 48.0	
		Total 98.0	Total 98.0	
3. Serie Ligg		1: 10.6x ↗ 2: 9.4 → 3: 9.1 ↘ 4: 9.9 ↘ 5: 10.0 ↘	4. Serie Ligg	 1: 10.3 ↖ 2: 10.4 → 3: 8.9 ↘ 4: 9.8 ↑ 5: 9.5 →
		Serie 47.0	Serie 46.0	
		Total 145.0	Total 191.0	
4. Serie Ligg		6: 10.8x ← 7: 10.7x → 8: 8.5 ↑ 9: 9.5 ↑	5. Serie Ligg	 1: 10.8x ↘ 2: 10.1 → 3: 10.1 → 4: 9.9 ↖ 5: 9.8 ↘
		Serie 37.0	Serie 48.0	
		Total 228.0	Total 276.0	

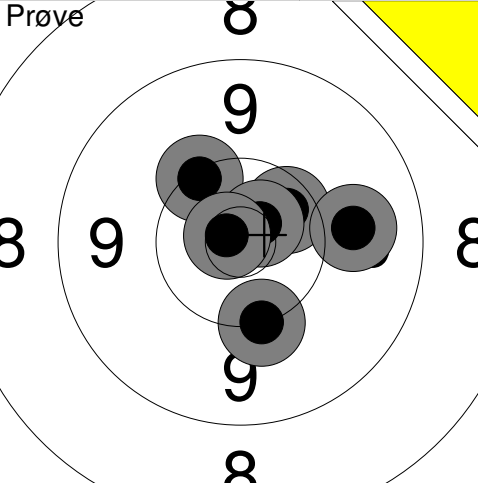
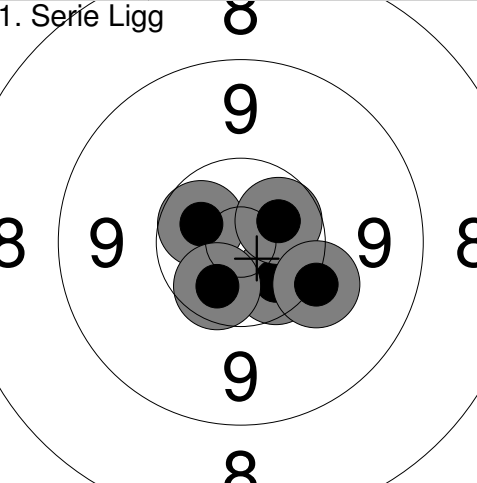
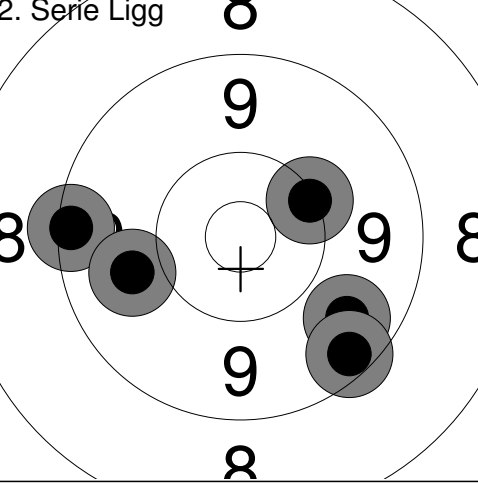
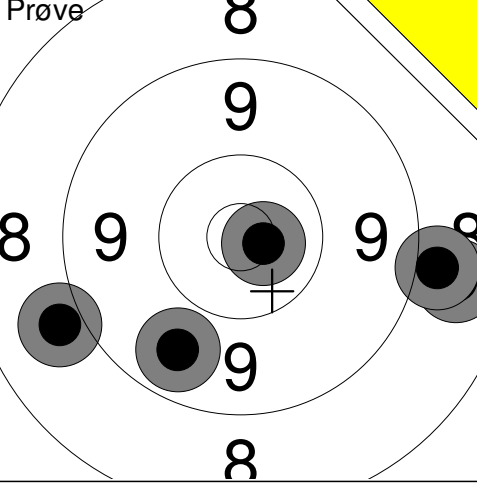
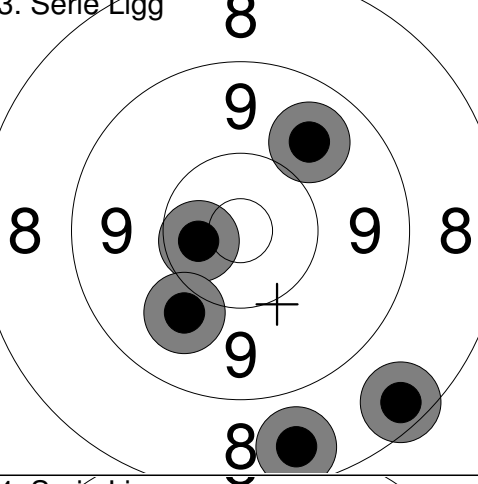
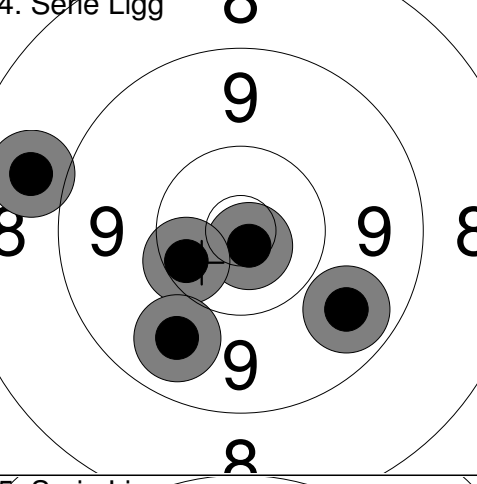
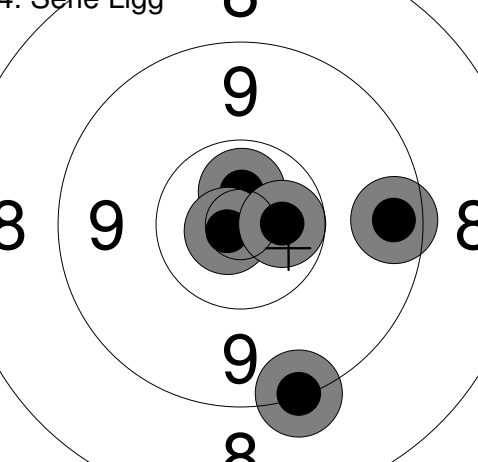
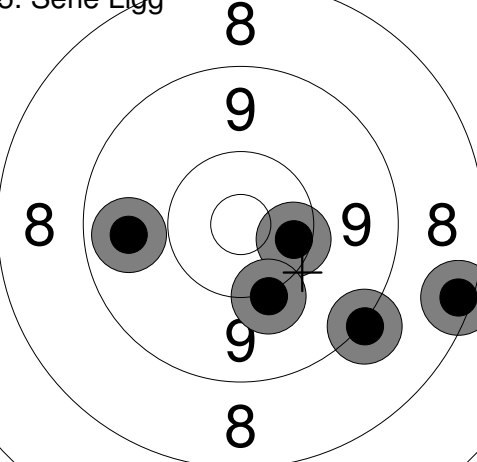
Hold	Skive	Jens E. Christiansen	
564	16		
50 meter afsnit 2		Sundeved Skytteforening	
		SEN	
		Landsstævne 2017	Aalborg Skyttekreds
Prøve		1: 10.4x ↗ 2: 10.2 ↗ 3: 10.7x ↗ 4: 10.2 ↓ 5: 9.9 → 6: 10.8x ↖	1. Serie Ligg
		Serie 59.0 Total 0.0	
			1: 10.5x ↓ 2: 10.5x ↖ 3: 10.5x ↓ 4: 10.5x ↗ 5: 10.1 ↓
2. Serie Ligg		1: 9.3 ← 2: 9.7 ↓ 3: 10.2 → 4: 9.9 ← 5: 9.4 ↓	Prøve
		Serie 46.0 Total 96.0	
			1: 9.7 ↓ 2: 10.7x ↗ 3: 8.7 → 4: 9.0 → 5: 8.9 ↖
3. Serie Ligg		1: 8.5 ↓ 2: 10.5x ← 3: 9.9 ↓ 4: 8.6 ↓ 5: 9.8 ↗	4. Serie Ligg
		Serie 44.0 Total 140.0	
			1: 8.8 ← 2: 9.7 ↓ 3: 10.8x ↓ 4: 10.4 ↖ 5: 9.8 ↓
4. Serie Ligg		6: 9.5 → 7: 10.6x ↑ 8: 10.8x ← 9: 9.2 ↓ 10: 10.6x →	5. Serie Ligg
		Serie 48.0 Total 234.0	
			1: 8.3 → 2: 9.1 ↓ 3: 10.4 → 4: 9.7 ← 5: 10.1 ↓
		Serie 46.0 Total 280.0	

Hold	Skive	Annette Munkbøl	
564	17		
50 meter afsnit 2		Aalborg Skyttekreds	
		SEN	
		Landsstævne 2017	
		Aalborg Skyttekreds	
Prøve		1. Serie Ligg	
	1: 10.2 ← 2: 10.4x ← 3: 10.5x → 4: 10.7x ↓ 5: 10.6x ↓		1: 9.9 ↓ 2: 10.1 → 3: 9.7 → 4: 10.1 ↓ 5: 10.5x ↗
	Serie 50.0		Serie 48.0
	Total 0.0		Total 48.0
2. Serie Ligg		Prøve	
	1: 10.0 ↗ 2: 10.5x ← 3: 10.5x ↓ 4: 8.0 ↓ 5: 7.5 →		1: 10.1 ↓ 2: 10.0 ↑ 3: 10.6x ← 4: 8.9 ← 5: 10.5x ↗
	Serie 45.0		Serie 48.0
	Total 93.0		Total 93.0
3. Serie Ligg		4. Serie Ligg	
	1: 9.6 ← 2: 10.1 ← 3: 9.6 ↗ 4: 8.5 ← 5: 9.3 ←		1: 8.4 ↑ 2: 8.1 → 3: 7.1 ↖ 4: 9.5 ↑ 5: 9.4 →
	Serie 45.0		Serie 41.0
	Total 138.0		Total 179.0
4. Serie Ligg		5. Serie Ligg	
	6: 9.7 ↗ 7: 10.8x ↗ 8: 10.5x ↗ 9: 10.1 → 10: 9.8 →		1: 7.5 ← 2: 9.8 ↓ 3: 10.3 → 4: 9.6 ↗ 5: 9.9 ↑
	Serie 48.0		Serie 44.0
	Total 227.0		Total 271.0

Prøve 	1: 10.4 ↖ 2: 9.8 ↙ 3: 10.3 ↖ 4: 8.8 → 5: 10.1 ↓ 6: 10.5x ↘ 7: 10.6x ↗ 8: 10.4 ↓ 9: 10.1 ↙ 10: 8.7 ↘	Prøve 	11: 9.0 ↖ 12: 10.6x ↗
Serie 95.0		Serie 19.0	
Total 0.0		Total 0.0	

1. Serie Ligg 	1: 9.6 ↑ 2: 9.3 ↗ 3: 10.1 ↑ 4: 10.0 ← 5: 9.5 ↘	2. Serie Ligg 	1: 10.3 ↖ 2: 8.8 → 3: 9.3 ↙ 4: 8.7 ↗ 5: 10.0 →
Serie 47.0		Serie 45.0	
Total 47.0		Total 92.0	

Prøve 	1: 9.7 ↖ 2: 10.2 ↗ 3: 9.6 ↗ 4: 7.5 ← 5: 10.2 ↓	3. Serie Ligg 	1: 9.1 ↓ 2: 9.2 ↑ 3: 9.5 ↙ 4: 8.9 → 5: 7.7 ↗
Serie 45.0		Serie 42.0	
Total 92.0		Total 134.0	

3. Serie Ligg 	6: 9.4 →	4. Serie Ligg 	1: 8.4 → 2: 10.0 ← 3: 10.4x → 4: 9.7 → 5: 8.8 ↑
Serie 9.0		Serie 45.0	
Total 143.0		Total 188.0	

4. Serie Ligg 	6: 9.1 ← 7: 9.5 ↖ 8: 8.5 ↗ 9: 9.5 ↙ 10: 9.4 ↑	5. Serie Ligg 	1: 10.3 ↘ 2: 9.9 ↗ 3: 10.1 ↗ 4: 9.5 ↗ 5: 10.4 ↗
Serie 44.0		Serie 48.0	
Total 232.0		Total 280.0	

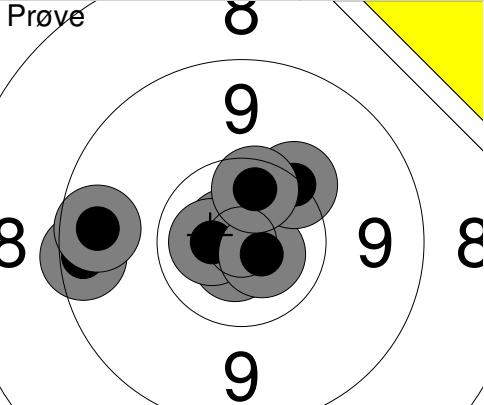
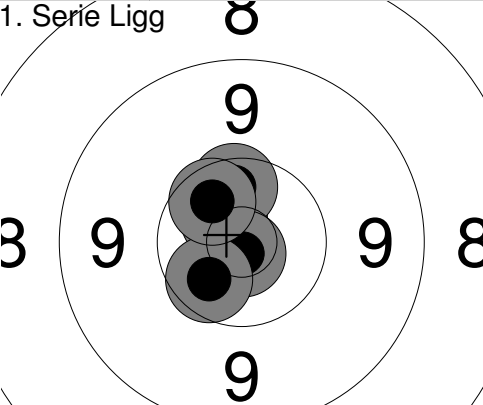
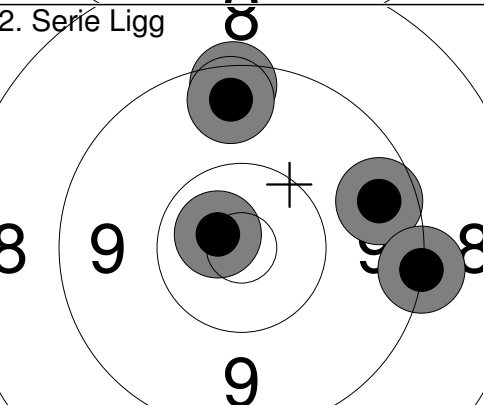
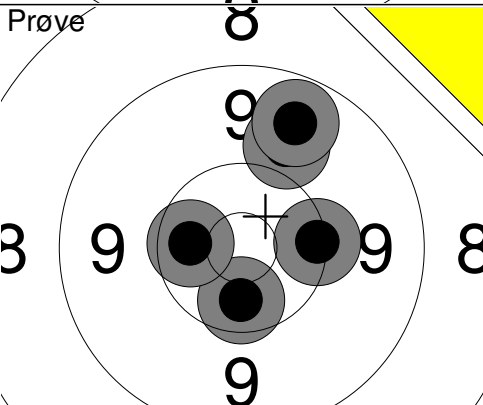
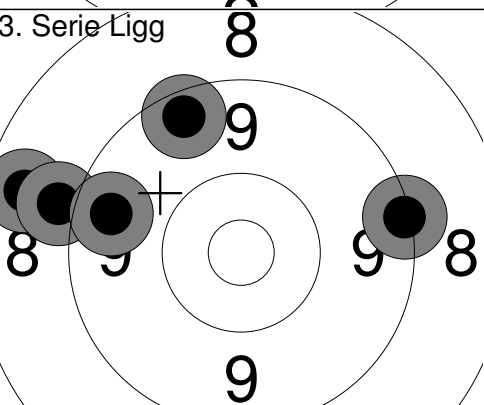
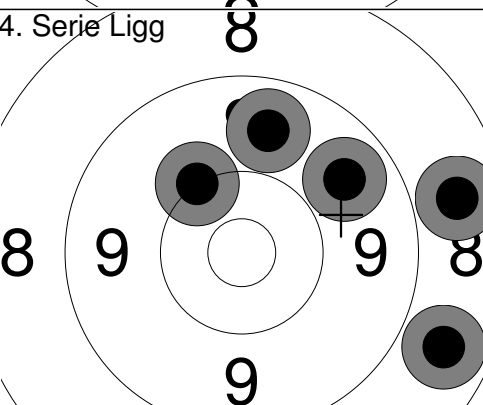
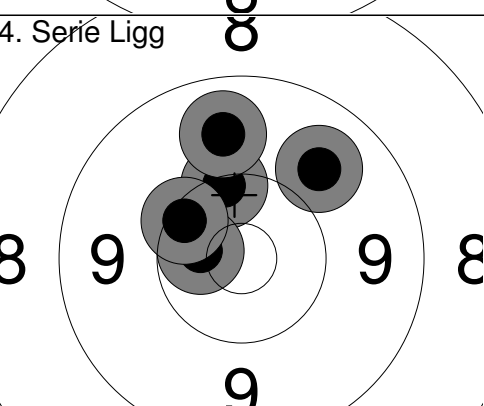
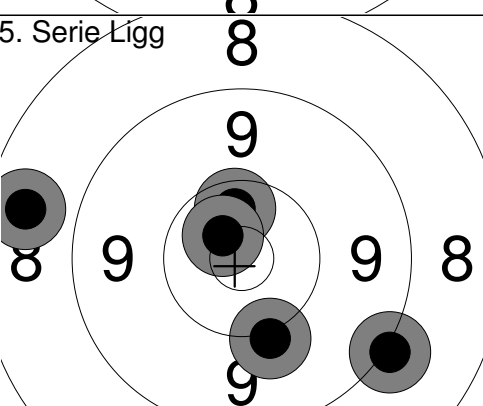

Hold	Skive	Claus Bruun			
564	19	50 meter afsnit 2			
Greve Skytteforening		SEN			
Landsstævne 2017		Aalborg Skyttekreds			
Prøve		1: 9.4 ← 2: 9.6 ← 3: 10.8x ↗ 4: 10.8x ↓ 5: 10.7x ← 6: 10.7x ↘ 7: 10.2 ↗ 8: 10.4x ↑	1. Serie Ligg		1: 10.7x ↗ 2: 10.4x ↑ 3: 10.8x ↓ 4: 10.5x ↙ 5: 10.5x ↗
	Serie 78.0		Serie 50.0		
	Total 0.0		Total 50.0		
2. Serie Ligg		1: 10.7x ↖ 2: 9.6 → 3: 9.2 → 4: 9.4 ↑ 5: 9.5 ↑	Prøve		1: 10.5x ↓ 2: 10.5x ← 3: 9.9 ↑ 4: 9.7 ↑ 5: 10.2 →
	Serie 46.0		Serie 48.0		
	Total 96.0		Total 96.0		
3. Serie Ligg		1: 8.6 ← 2: 9.0 ← 3: 9.4 ↗ 4: 9.6 ↖ 5: 9.2 →	4. Serie Ligg		1: 8.7 → 2: 9.7 ↑ 3: 8.7 ↘ 4: 10.2 ↗ 5: 9.7 ↗
	Serie 44.0		Serie 44.0		
	Total 140.0		Total 184.0		
4. Serie Ligg		6: 10.2 ↑ 7: 10.6x ← 8: 10.3 ↗ 9: 9.8 ↗ 10: 9.8 ↑	5. Serie Ligg		1: 8.6 ← 2: 10.1 ↓ 3: 10.4x ↑ 4: 10.6x ↗ 5: 9.1 ↓
	Serie 48.0		Serie 47.0		
	Total 232.0		Total 279.0		

Hold	Skive	Thomas Brokholm	
564	20		
50 meter afsnit 2		Sønderborg Skyttekreds	
		SEN	
		Landsstævne 2017	
		Aalborg Skyttekreds	
Prøve		1: 10.4x ↘ 2: 10.3 ↓ 3: 10.1 ↘ 4: 10.0 ↗ 5: 9.7 → 6: 10.0 ↑	1. Serie Ligg
		Serie 59.0 Total 0.0	 1: 10.6x ↑ 2: 10.5x ↘ 3: 10.7x ↓ 4: 10.5x ← 5: 10.6x ↓ Serie 50.0 Total 50.0
2. Serie Ligg		1: 8.9 ← 2: 8.2 ↘ 3: 9.4 ↓ 4: 10.1 → 5: 8.1 ←	Prøve
		Serie 43.0 Total 93.0	 1: 8.9 ← 2: 9.9 ↑ 3: 10.2 ↘ 4: 9.7 → 5: 9.3 ← Serie 45.0 Total 93.0
3. Serie Ligg		1: 10.2 → 2: 9.3 → 3: 7.2 ↘ 4: 10.7x ↘ 5: 10.4 ↗	4. Serie Ligg
		Serie 46.0 Total 139.0	 1: 7.0 ↘ 2: 10.1 ↓ 3: 10.2 ↑ 4: 9.2 ↗ 5: 10.4 ← Serie 46.0 Total 185.0
4. Serie Ligg		6: 10.0 ↘ 7: 10.5x ↘ 8: 9.6 ← 9: 10.5x ← 10: 10.9x ↓	5. Serie Ligg
		Serie 49.0 Total 234.0	 1: 7.4 ← 2: 7.8 ← 3: 8.4 ← 4: 10.8x ↗ 5: 10.6x → Serie 42.0 Total 276.0

Hold	Skive	Kristian Ebbensgaard	
565	13		
50 meter afsnit 2		Greve Skytteforening	
		LIG	
		Landsstævne 2017	
		Aalborg Skyttekreds	
Prøve		1: 10.8x ← 2: 10.0 → 3: 9.4 ↘ 4: 10.0 ↗ 5: 10.2 ← 6: 10.7x ← 7: 10.7x → 8: 10.3 ↗ 9: 9.6 ↓	Ligg
		Serie 88.0 Total 0.0	1: 10.8x ↑ 2: 9.8 ↑ 3: 10.5x ↗ 4: 10.7x ↓ 5: 10.5x ↓
			Serie 49.0 Total 49.0
Ligg		6: 10.6x ↓ 7: 10.4x → 8: 10.6x ↑ 9: 10.5x ↑ 10: 10.6x ↓	Stå
		Serie 50.0 Total 99.0	1: 8.9 ↓ 2: 10.4x ↖ 3: 10.1 ↗ 4: 9.7 → 5: 10.2 ↗
			Serie 47.0 Total 146.0
Knæ		1: 9.9 ↘ 2: 10.7x ↗ 3: 10.5x → 4: 9.5 ↑ 5: 9.8 ↗	Knæ
		Serie 47.0 Total 193.0	6: 9.1 ↘ 7: 9.4 ↑
			Serie 18.0 Total 211.0
Prøve		1: 10.1 → 2: 10.1 → 3: 10.1 → 4: 10.1 ↗ 5: 9.9 ↗	3S+3K+4L
		Serie 49.0 Total 211.0	1: 9.7 ← 2: 10.8x ↓ 3: 10.6x → 4: 10.4 → 5: 10.6x ↘
			Serie 49.0 Total 260.0
Stå		1: 9.8 → 2: 10.3 ↗ 3: 10.2 → 4: 10.3 ↘ 5: 10.7x ↗	
		Serie 49.0 Total 309.0	

Hold	Skive	Jens-Ulrik Ladekjær-Mikkelsen	
565	14	Ammitsbøl SG&I	
50 meter afsnit 2		LIG	
Landsstævne 2017		Aalborg Skyttekreds	
Prøve		1: 9.4 ↗ 2: 10.4 ↗ 3: 9.9 ↗ 4: 10.5x ↗ 5: 9.9 ↓ 6: 10.7x ↓ 7: 10.6x ↗ 8: 10.4 ↗	Ligg
		Serie 77.0 Total 0.0	1: 10.4 ↑ 2: 10.5x ← 3: 10.7x ↗ 4: 10.2 ↗ 5: 10.5x ←
Ligg		6: 10.6x ↓ 7: 10.7x ↓ 8: 10.1 ↓ 9: 10.2 → 10: 10.7x ↓	Stå
		Serie 50.0 Total 100.0	1: 10.7x → 2: 10.8x ↑ 3: 10.9x ↗ 4: 10.1 ↓ 5: 10.5x ↗
Knæ		1: 10.1 ← 2: 10.2 ← 3: 10.5x ↗ 4: 10.3 ↓ 5: 10.5x ↗	Knæ
		Serie 50.0 Total 200.0	6: 10.5x ↓
Prøve		1: 10.6x → 2: 10.5x ↓ 3: 10.3 ↑ 4: 10.3 → 5: 10.7x ←	3S+3K+4L
		Serie 50.0 Total 210.0	1: 10.6x ↓ 2: 10.8x ↗ 3: 10.3 ← 4: 10.8x ↓ 5: 10.2 ↗
Stå		1: 10.4 ↗ 2: 10.7x ↗ 3: 10.6x ← 4: 10.8x → 5: 10.7x ↗	
		Serie 50.0 Total 310.0	

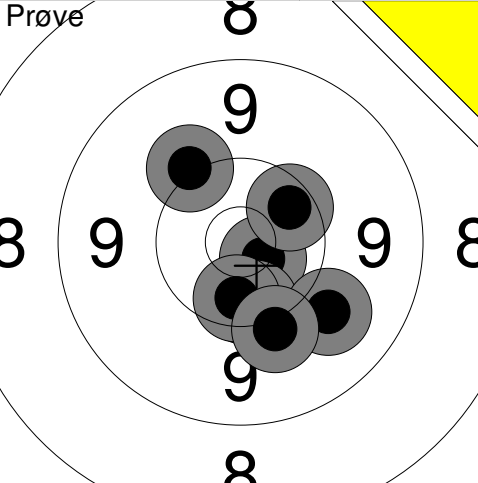
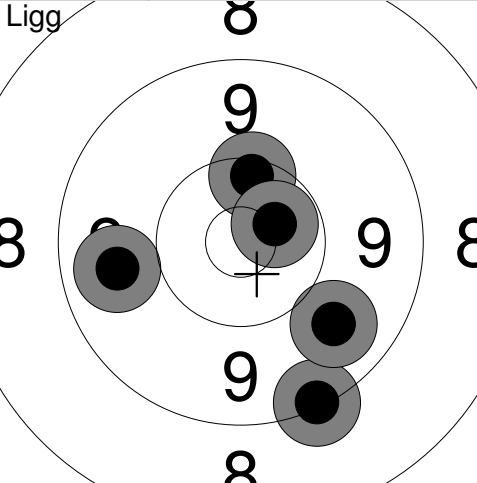
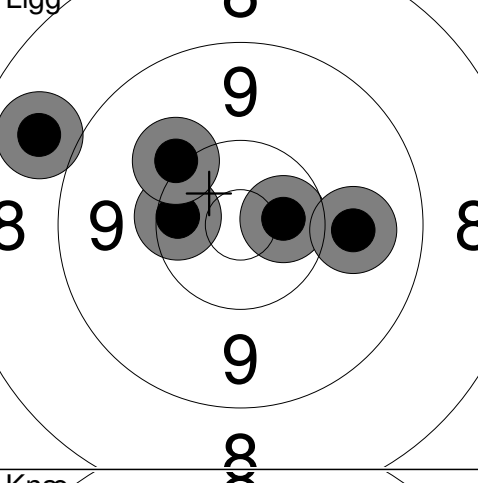
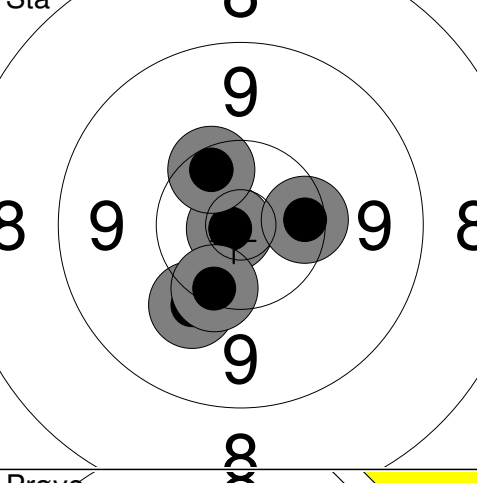
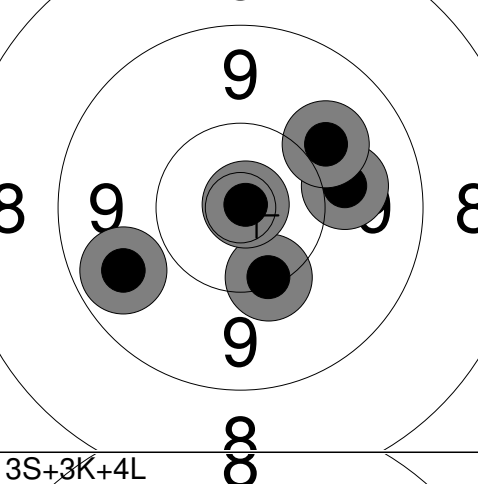
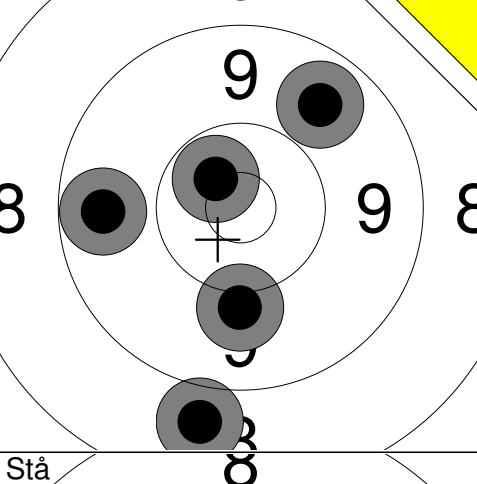
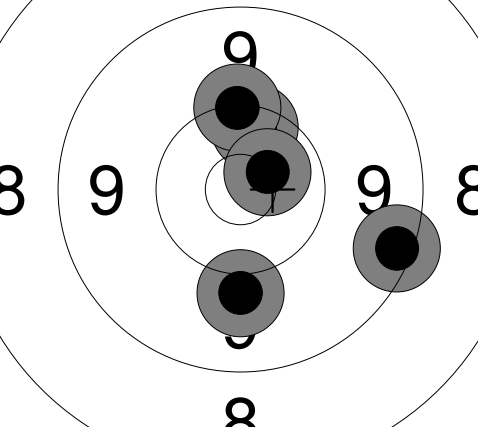
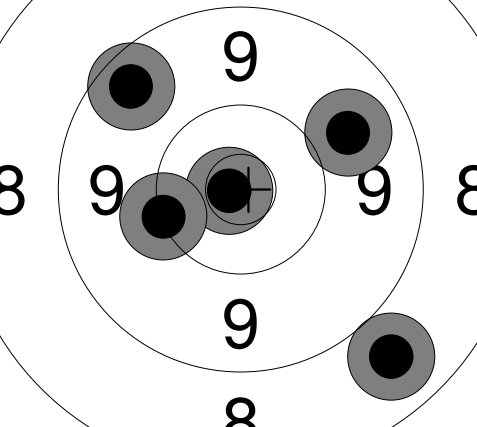
Hold	Skive	Ole Vagn Larsen			
565	15				
50 meter afsnit 2		Hjørring Skytteforening			
		LIG			
		Landsstævne 2017	Aalborg Skyttekreds		
Prøve		1: 10.4 ↓ 2: 10.7x ↓ 3: 10.4 ↓ 4: 9.9 ↓ 5: 10.4 → 6: 10.4x ↓ 7: 10.1 ↗ 8: 10.1 ↓	Ligg		1: 9.8 ← 2: 9.2 ↓ 3: 10.3 ↑ 4: 10.6x → 5: 9.8 ↓
		Serie 79.0			Serie 47.0
		Total 0.0			Total 47.0
Ligg		6: 8.8 ← 7: 10.4 ← 8: 10.5x → 9: 9.9 → 10: 10.1 ↗	Stå		1: 10.8x ← 2: 10.3 → 3: 10.1 ↓ 4: 10.4 ↗ 5: 10.3 ↓
		Serie 47.0			Serie 50.0
		Total 94.0			Total 144.0
Knæ		1: 10.2 ↓ 2: 9.9 → 3: 9.9 ↗ 4: 9.7 ← 5: 10.9x ↗	Prøve		1: 9.7 ↗ 2: 10.6x ↗ 3: 9.6 ← 4: 8.8 ↓ 5: 10.0 ↓
		Serie 47.0			Serie 46.0
		Total 191.0			Total 191.0
3S+3K+4L		1: 10.0 ↓ 2: 10.4 ↑ 3: 9.3 → 4: 10.2 ↑ 5: 10.6x ↗	Stå		1: 9.5 ↗ 2: 8.8 ↓ 3: 9.8 → 4: 10.8x ← 5: 10.2 ←
		Serie 49.0			Serie 46.0
		Total 240.0			Total 286.0

Hold	Skive	Karsten Jensen		
565	16			
50 meter afsnit 2		Haderup Skytteforening		
		LIG		
Landsstævne 2017		Aalborg Skyttekreds		
Prøve		1: 10.0 → 2: 9.9 ↗ 3: 8.4 ↗ 4: 9.9 ↘ 5: 9.8 ↗ 6: 9.9 ↘ 7: 9.8 ←	Ligg	1: 9.8 ← 2: 9.1 ↘ 3: 9.3 ↘ 4: 6.6 ← 5: 9.6 ↘
		Serie 63.0		Serie 42.0
		Total 0.0		Total 42.0
Ligg		6: 8.1 ↘ 7: 10.4 ↘ 8: 10.0 ↗ 9: 9.8 ↗ 10: 8.7 ↗	Stå	1: 7.2 ↑ 2: 10.7x ↘ 3: 6.9 ← 4: 10.1 ↗ 5: 10.1 →
		Serie 45.0		Serie 43.0
		Total 87.0		Total 130.0
Knæ		1: 7.9 ↗ 2: 9.4 ↑ 3: 9.5 ↗ 4: 9.7 ↗ 5: 8.9 ↘	Prøve	1: 10.7x ↗ 2: 9.6 → 3: 9.6 ↗ 4: 9.9 → 5: 10.7x ↗
		Serie 42.0		Serie 47.0
		Total 172.0		Total 172.0
3S+3K+4L		1: 7.3 ↗ 2: 9.1 ↘ 3: 7.9 ↗ 4: 7.4 ↗ 5: 9.8 ↘	Stå	1: 8.9 ↘ 2: 9.3 → 3: 9.3 ↑ 4: 8.1 ↗ 5: 9.6 ↗
		Serie 39.0		Serie 43.0
		Total 211.0		Total 254.0

Hold	Skive	Sine H. Jensen		
565	17			
50 meter afsnit 2		Stege Ndr. Skytteforening		
		LIG		
		Landsstævne 2017	Aalborg Skyttekreds	
Prøve		1: 10.1 ↑ 2: 10.8x ↓ 3: 9.6 ↓ 4: 8.6 ↓ 5: 9.3 ↓ 6: 9.7 → 7: 10.2 ← 8: 10.3 ↑ 9: 9.5 ↓ 10: 9.8 ↓	Prøve	11: 9.2 ↑ 12: 10.5x ↓
		Serie 93.0		Serie 19.0
		Total 0.0		Total 0.0
Ligg		1: 9.8 ↑ 2: 9.0 ↑ 3: 10.0 ← 4: 9.5 ← 5: 9.8 ↓	Ligg	6: 10.3 ← 7: 10.4 ↓ 8: 9.5 ↓ 9: 9.5 → 10: 10.2 ↑
		Serie 46.0		Serie 48.0
		Total 46.0		Total 94.0
Stå		1: 10.2 → 2: 9.6 ↓ 3: 10.4x ← 4: 9.3 → 5: 10.5x ↑	Knæ	1: 9.9 ↑ 2: 9.8 ↑ 3: 10.2 → 4: 9.8 ↑ 5: 10.1 ←
		Serie 48.0		Serie 47.0
		Total 142.0		Total 189.0
Knæ		6: 10.5x ↓ 7: 10.7x ↓ 8: 9.5 ↓ 9: 10.4 ↓	Prøve	1: 10.5x ↓ 2: 9.4 ↑ 3: 9.9 ↓ 4: 9.4 ↓ 5: 9.9 ↓
		Serie 39.0		Serie 46.0
		Total 228.0		Total 228.0
3S+3K+4L		1: 8.6 ↑ 2: 10.3 ↑ 3: 10.2 ↑ 4: 10.2 → 5: 10.4 →	Stå	1: 10.8x → 2: 10.0 ↓ 3: 8.6 ↑ 4: 10.7x → 5: 10.4 ↓
		Serie 48.0		Serie 48.0
		Total 276.0		Total 324.0

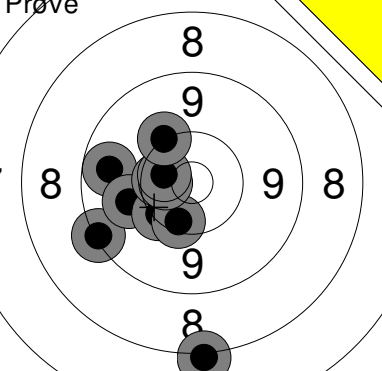
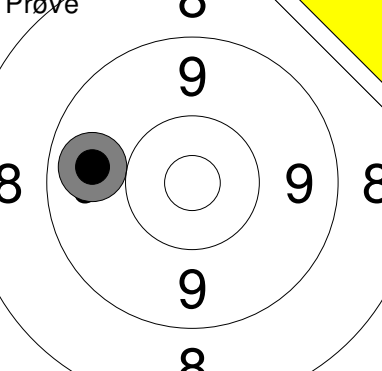
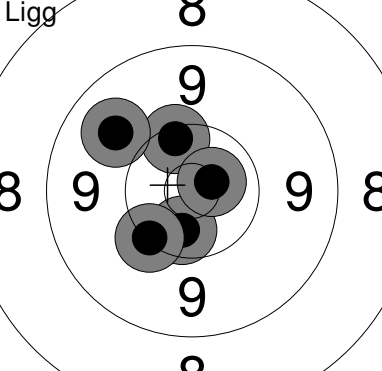
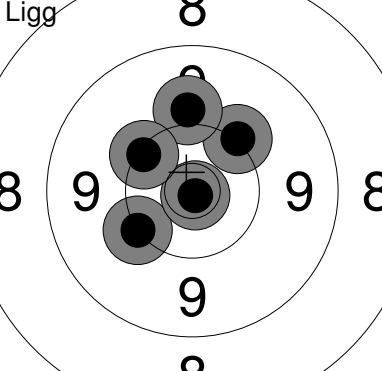
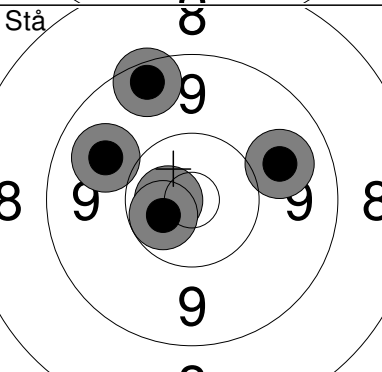
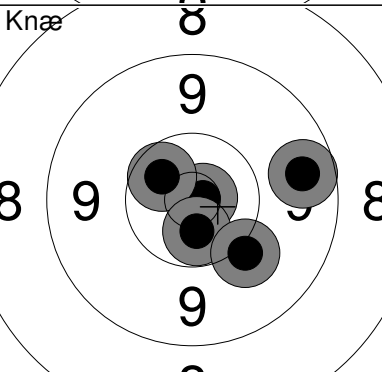
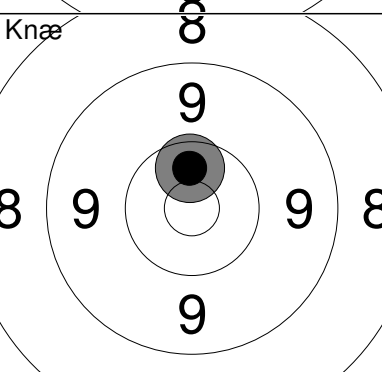
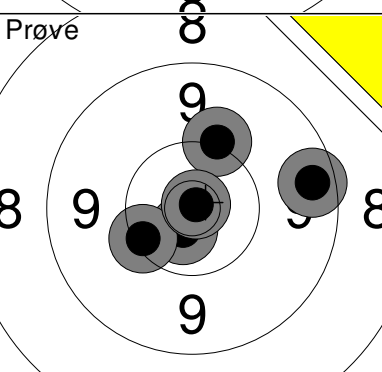
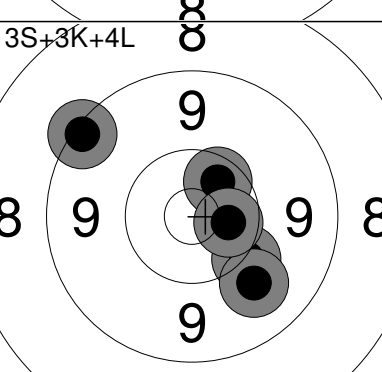
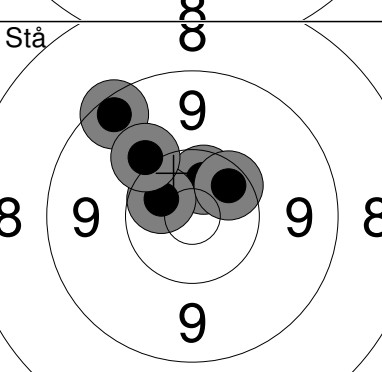
<b>Prøve</b>																																																
	<table border="1" style="width:100%; border-collapse: collapse;"> <tr><td>1:</td><td>8.1</td><td>↓</td></tr> <tr><td>2:</td><td>9.2</td><td>↙</td></tr> <tr><td>3:</td><td>9.6</td><td>↙</td></tr> <tr><td>4:</td><td>9.9</td><td>↙</td></tr> <tr><td>5:</td><td>10.3</td><td>↙</td></tr> <tr><td>6:</td><td>10.4x</td><td>↙</td></tr> <tr><td>7:</td><td>10.3</td><td>↓</td></tr> <tr><td>8:</td><td>10.5x</td><td>↙</td></tr> <tr><td>9:</td><td>10.5x</td><td>↙</td></tr> <tr><td>10:</td><td>10.1</td><td>↗</td></tr> <tr><td colspan="2"><b>Serie</b></td><td><b>95.0</b></td></tr> <tr><td colspan="2"><b>Total</b></td><td><b>0.0</b></td></tr> </table>	1:	8.1	↓	2:	9.2	↙	3:	9.6	↙	4:	9.9	↙	5:	10.3	↙	6:	10.4x	↙	7:	10.3	↓	8:	10.5x	↙	9:	10.5x	↙	10:	10.1	↗	<b>Serie</b>		<b>95.0</b>	<b>Total</b>		<b>0.0</b>		<table border="1" style="width:100%; border-collapse: collapse;"> <tr><td>11:</td><td>9.7</td><td>↙</td></tr> <tr><td colspan="2"><b>Serie</b></td><td><b>9.0</b></td></tr> <tr><td colspan="2"><b>Total</b></td><td><b>0.0</b></td></tr> </table>	11:	9.7	↙	<b>Serie</b>		<b>9.0</b>	<b>Total</b>		<b>0.0</b>
1:	8.1	↓																																														
2:	9.2	↙																																														
3:	9.6	↙																																														
4:	9.9	↙																																														
5:	10.3	↙																																														
6:	10.4x	↙																																														
7:	10.3	↓																																														
8:	10.5x	↙																																														
9:	10.5x	↙																																														
10:	10.1	↗																																														
<b>Serie</b>		<b>95.0</b>																																														
<b>Total</b>		<b>0.0</b>																																														
11:	9.7	↙																																														
<b>Serie</b>		<b>9.0</b>																																														
<b>Total</b>		<b>0.0</b>																																														
<b>Ligg</b>		<b>Ligg</b>																																														
	<table border="1" style="width:100%; border-collapse: collapse;"> <tr><td>1:</td><td>10.5x</td><td>↓</td></tr> <tr><td>2:</td><td>10.2</td><td>↙</td></tr> <tr><td>3:</td><td>10.3</td><td>↗</td></tr> <tr><td>4:</td><td>10.7x</td><td>↗</td></tr> <tr><td>5:</td><td>9.8</td><td>↗</td></tr> <tr><td colspan="2"><b>Serie</b></td><td><b>49.0</b></td></tr> <tr><td colspan="2"><b>Total</b></td><td><b>49.0</b></td></tr> </table>	1:	10.5x	↓	2:	10.2	↙	3:	10.3	↗	4:	10.7x	↗	5:	9.8	↗	<b>Serie</b>		<b>49.0</b>	<b>Total</b>		<b>49.0</b>		<table border="1" style="width:100%; border-collapse: collapse;"> <tr><td>6:</td><td>10.1</td><td>↗</td></tr> <tr><td>7:</td><td>10.2</td><td>↙</td></tr> <tr><td>8:</td><td>10.9x</td><td>↙</td></tr> <tr><td>9:</td><td>10.0</td><td>↑</td></tr> <tr><td>10:</td><td>10.2</td><td>↗</td></tr> <tr><td colspan="2"><b>Serie</b></td><td><b>50.0</b></td></tr> <tr><td colspan="2"><b>Total</b></td><td><b>99.0</b></td></tr> </table>	6:	10.1	↗	7:	10.2	↙	8:	10.9x	↙	9:	10.0	↑	10:	10.2	↗	<b>Serie</b>		<b>50.0</b>	<b>Total</b>		<b>99.0</b>			
1:	10.5x	↓																																														
2:	10.2	↙																																														
3:	10.3	↗																																														
4:	10.7x	↗																																														
5:	9.8	↗																																														
<b>Serie</b>		<b>49.0</b>																																														
<b>Total</b>		<b>49.0</b>																																														
6:	10.1	↗																																														
7:	10.2	↙																																														
8:	10.9x	↙																																														
9:	10.0	↑																																														
10:	10.2	↗																																														
<b>Serie</b>		<b>50.0</b>																																														
<b>Total</b>		<b>99.0</b>																																														
<b>Stå</b>		<b>Knæ</b>																																														
	<table border="1" style="width:100%; border-collapse: collapse;"> <tr><td>1:</td><td>9.8</td><td>↗</td></tr> <tr><td>2:</td><td>10.7x</td><td>↙</td></tr> <tr><td>3:</td><td>9.8</td><td>↙</td></tr> <tr><td>4:</td><td>9.4</td><td>↗</td></tr> <tr><td>5:</td><td>10.6x</td><td>↙</td></tr> <tr><td colspan="2"><b>Serie</b></td><td><b>47.0</b></td></tr> <tr><td colspan="2"><b>Total</b></td><td><b>146.0</b></td></tr> </table>	1:	9.8	↗	2:	10.7x	↙	3:	9.8	↙	4:	9.4	↗	5:	10.6x	↙	<b>Serie</b>		<b>47.0</b>	<b>Total</b>		<b>146.0</b>		<table border="1" style="width:100%; border-collapse: collapse;"> <tr><td>1:</td><td>10.8x</td><td>↗</td></tr> <tr><td>2:</td><td>10.5x</td><td>↗</td></tr> <tr><td>3:</td><td>10.6x</td><td>↙</td></tr> <tr><td>4:</td><td>9.6</td><td>↗</td></tr> <tr><td>5:</td><td>10.1</td><td>↙</td></tr> <tr><td colspan="2"><b>Serie</b></td><td><b>49.0</b></td></tr> <tr><td colspan="2"><b>Total</b></td><td><b>195.0</b></td></tr> </table>	1:	10.8x	↗	2:	10.5x	↗	3:	10.6x	↙	4:	9.6	↗	5:	10.1	↙	<b>Serie</b>		<b>49.0</b>	<b>Total</b>		<b>195.0</b>			
1:	9.8	↗																																														
2:	10.7x	↙																																														
3:	9.8	↙																																														
4:	9.4	↗																																														
5:	10.6x	↙																																														
<b>Serie</b>		<b>47.0</b>																																														
<b>Total</b>		<b>146.0</b>																																														
1:	10.8x	↗																																														
2:	10.5x	↗																																														
3:	10.6x	↙																																														
4:	9.6	↗																																														
5:	10.1	↙																																														
<b>Serie</b>		<b>49.0</b>																																														
<b>Total</b>		<b>195.0</b>																																														
<b>Knæ</b>		<b>Prøve</b>																																														
	<table border="1" style="width:100%; border-collapse: collapse;"> <tr><td>6:</td><td>10.5x</td><td>↑</td></tr> <tr><td colspan="2"><b>Serie</b></td><td><b>10.0</b></td></tr> <tr><td colspan="2"><b>Total</b></td><td><b>205.0</b></td></tr> </table>	6:	10.5x	↑	<b>Serie</b>		<b>10.0</b>	<b>Total</b>		<b>205.0</b>		<table border="1" style="width:100%; border-collapse: collapse;"> <tr><td>1:</td><td>10.1</td><td>↑</td></tr> <tr><td>2:</td><td>9.5</td><td>→</td></tr> <tr><td>3:</td><td>10.7x</td><td>↙</td></tr> <tr><td>4:</td><td>10.3</td><td>↙</td></tr> <tr><td>5:</td><td>10.9x</td><td>↗</td></tr> <tr><td colspan="2"><b>Serie</b></td><td><b>49.0</b></td></tr> <tr><td colspan="2"><b>Total</b></td><td><b>205.0</b></td></tr> </table>	1:	10.1	↑	2:	9.5	→	3:	10.7x	↙	4:	10.3	↙	5:	10.9x	↗	<b>Serie</b>		<b>49.0</b>	<b>Total</b>		<b>205.0</b>															
6:	10.5x	↑																																														
<b>Serie</b>		<b>10.0</b>																																														
<b>Total</b>		<b>205.0</b>																																														
1:	10.1	↑																																														
2:	9.5	→																																														
3:	10.7x	↙																																														
4:	10.3	↙																																														
5:	10.9x	↗																																														
<b>Serie</b>		<b>49.0</b>																																														
<b>Total</b>		<b>205.0</b>																																														
<b>3S+3K+4L</b>		<b>Stå</b>																																														
	<table border="1" style="width:100%; border-collapse: collapse;"> <tr><td>1:</td><td>10.1</td><td>↙</td></tr> <tr><td>2:</td><td>9.9</td><td>↙</td></tr> <tr><td>3:</td><td>9.3</td><td>↗</td></tr> <tr><td>4:</td><td>10.4x</td><td>↗</td></tr> <tr><td>5:</td><td>10.5x</td><td>↘</td></tr> <tr><td colspan="2"><b>Serie</b></td><td><b>48.0</b></td></tr> <tr><td colspan="2"><b>Total</b></td><td><b>253.0</b></td></tr> </table>	1:	10.1	↙	2:	9.9	↙	3:	9.3	↗	4:	10.4x	↗	5:	10.5x	↘	<b>Serie</b>		<b>48.0</b>	<b>Total</b>		<b>253.0</b>		<table border="1" style="width:100%; border-collapse: collapse;"> <tr><td>1:</td><td>10.5x</td><td>↑</td></tr> <tr><td>2:</td><td>9.4</td><td>↗</td></tr> <tr><td>3:</td><td>10.5x</td><td>↗</td></tr> <tr><td>4:</td><td>10.1</td><td>↗</td></tr> <tr><td>5:</td><td>10.4</td><td>↗</td></tr> <tr><td colspan="2"><b>Serie</b></td><td><b>49.0</b></td></tr> <tr><td colspan="2"><b>Total</b></td><td><b>302.0</b></td></tr> </table>	1:	10.5x	↑	2:	9.4	↗	3:	10.5x	↗	4:	10.1	↗	5:	10.4	↗	<b>Serie</b>		<b>49.0</b>	<b>Total</b>		<b>302.0</b>			
1:	10.1	↙																																														
2:	9.9	↙																																														
3:	9.3	↗																																														
4:	10.4x	↗																																														
5:	10.5x	↘																																														
<b>Serie</b>		<b>48.0</b>																																														
<b>Total</b>		<b>253.0</b>																																														
1:	10.5x	↑																																														
2:	9.4	↗																																														
3:	10.5x	↗																																														
4:	10.1	↗																																														
5:	10.4	↗																																														
<b>Serie</b>		<b>49.0</b>																																														
<b>Total</b>		<b>302.0</b>																																														



Hold	Skive	Finn Karlsson	
565	19	50 meter afsnit 2	Skals Skytteforening
		Landsstævne 2017	Aalborg Skyttekreds
Prøve		1: 10.3 → 2: 10.7x ↓ 3: 10.2 ↑ 4: 10.1 ↓ 5: 10.1 ↓ 6: 10.2 ↑ 7: 10.0 ↓ 8: 10.7x ↓	Ligg
		Serie 80.0	1: 9.8 ↓ 2: 10.7x ↓ 3: 9.9 ← 4: 9.4 ← 5: 10.1 ↑
		Total 0.0	Serie 47.0
			Total 47.0
Ligg		6: 10.3 ↓ 7: 10.2 ↓ 8: 10.4 ↑ 9: 8.6 → 10: 9.8 ↓	Stå
		Serie 47.0	1: 10.2 ↑ 2: 10.5x ← 3: 10.2 ↓ 4: 10.1 → 5: 10.5x ↑
		Total 94.0	Serie 50.0
			Total 144.0
Knæ		1: 9.7 ↓ 2: 10.1 ↓ 3: 9.7 ↓ 4: 8.7 ↓ 5: 10.7x ←	Prøve
		Serie 46.0	1: 10.6x ↑ 2: 10.3 ↓ 3: 10.2 ← 4: 10.1 → 5: 10.8x ↓
		Total 190.0	Serie 50.0
			Total 190.0
3S+3K+4L		1: 10.1 ↓ 2: 9.9 ↓ 3: 10.5x → 4: 10.7x ↑ 5: 10.4x →	Stå
		Serie 49.0	1: 9.8 ← 2: 10.3 ↓ 3: 10.5x → 4: 10.3 ← 5: 10.3 ←
		Total 239.0	Serie 49.0
			Total 288.0

Hold	Skive	Brian Rubæk	
565	20		
50 meter afsnit 2		Skf. Kimbrenne	
		LIG	
		Landsstævne 2017	
		Aalborg Skyttekreds	
Prøve		1: 10.7x ↘ 2: 10.7x ↓ 3: 10.3 ↗ 4: 9.7 ← 5: 10.9x ↘ 6: 10.3 ↑ 7: 9.9 ↗ 8: 10.3 ↓ 9: 9.9 ↑ 10: 10.5x ↗	Ligg
		Serie 97.0 Total 0.0	1: 10.8x ↗ 2: 9.7 ↗ 3: 10.6x → 4: 10.0 ↑ 5: 10.1 ↑
Ligg		6: 10.0 ↘ 7: 10.7x → 8: 10.8x ← 9: 10.7x ↓ 10: 10.0 ←	Stå
		Serie 50.0 Total 99.0	1: 10.0 ↑ 2: 10.8x ↓ 3: 10.5x ↓ 4: 10.5x → 5: 10.8x ↙
Knæ		1: 10.6x ↗ 2: 9.6 ↗ 3: 9.5 ↗ 4: 10.8x → 5: 10.9x ↗	Knæ
		Serie 48.0 Total 197.0	6: 9.7 →
Prøve		1: 10.4x ↗ 2: 10.2 → 3: 10.4x ↗ 4: 10.6x ↓ 5: 10.6x ↗	3S+3K+4L
		Serie 50.0 Total 206.0	1: 10.4 ↗ 2: 10.5x ↙ 3: 10.7x ↓ 4: 9.9 ↗ 5: 9.8 ↑
Stå		1: 10.3 ← 2: 9.3 ↗ 3: 10.0 ↗ 4: 10.0 ↗ 5: 10.1 ↗	
		Serie 49.0 Total 303.0	

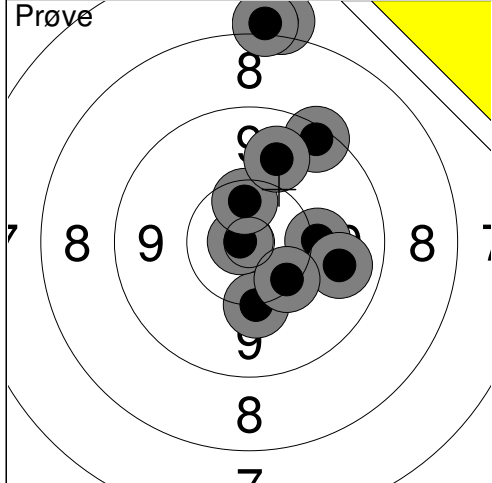

1:	8.0	↑
2:	9.3	↗
3:	8.0	↑
4:	10.1	→
5:	9.8	→
6:	10.2	↓
7:	10.8x	←
8:	10.4x	↑
9:	10.3	↘
10:	9.8	↑
Serie		93.0
Total		0.0

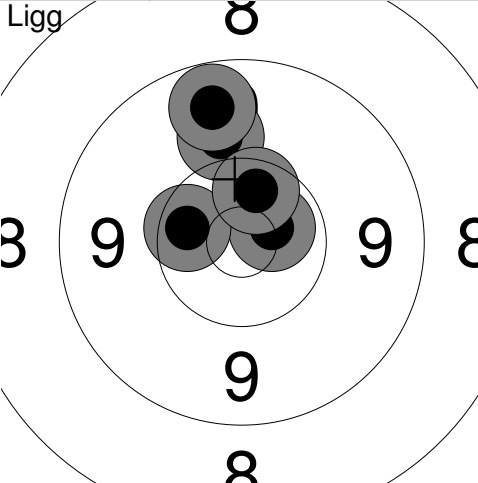

1:	10.6x	↗
2:	9.9	↑
3:	9.6	↑
4:	10.4x	←
5:	10.4x	↑
Serie		48.0
Total		48.0

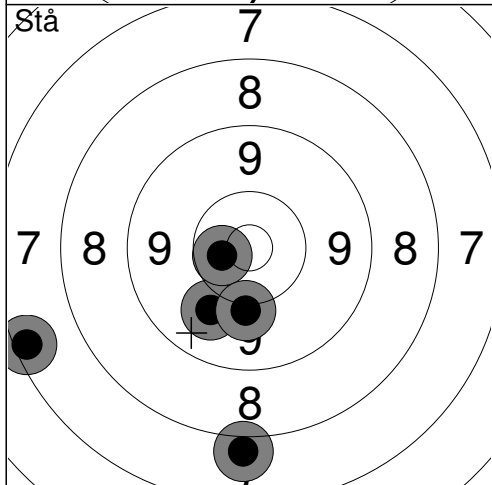

1:	9.9	↓
2:	10.6x	←
3:	7.4	←
4:	10.1	↓
5:	7.9	↓
Serie		43.0
Total		91.0

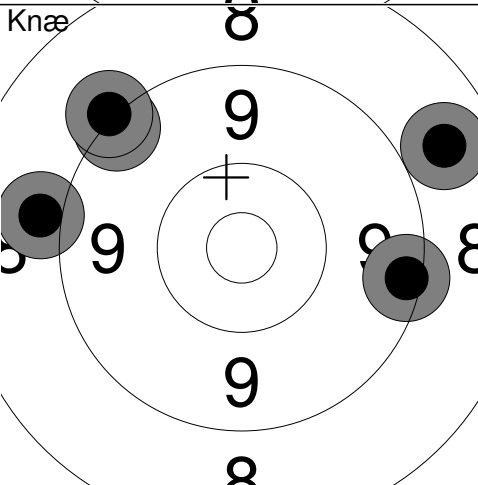

1:	9.3	↗
2:	9.3	→
3:	9.0	←
4:	9.1	↗
5:	8.7	→
Serie		44.0
Total		135.0

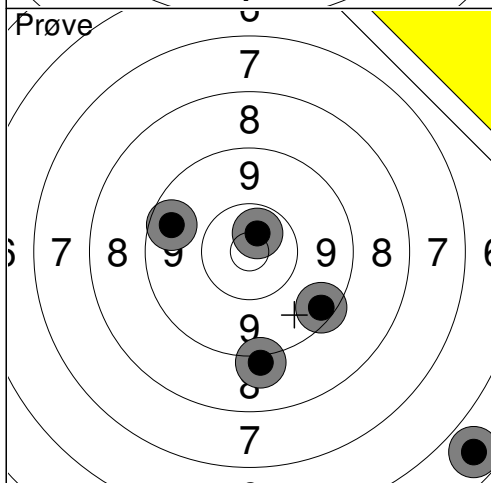

1:	9.0	↓
2:	9.4	↘
3:	5.7	↘
4:	10.6x	↑
5:	9.6	←
Serie		42.0
Total		135.0

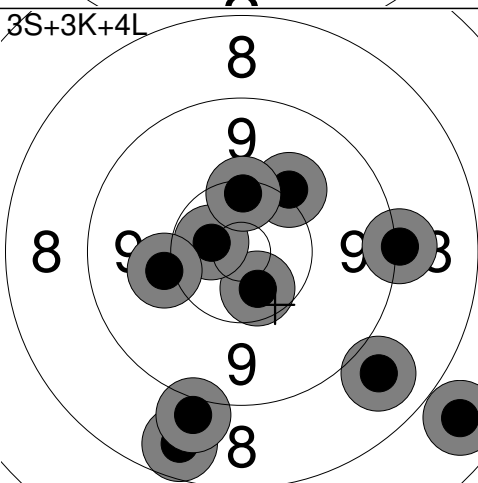

1:	10.5x	↓
2:	8.6	↓
3:	9.0	↓
4:	7.7	↘
5:	9.1	→
6:	10.6x	←
7:	10.1	↗
8:	8.8	↘
9:	10.1	←
10:	10.3	↑
Serie		91.0
Total		226.0

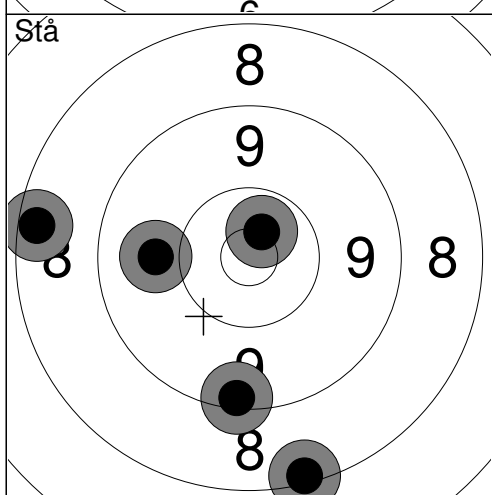

1:	10.6x	↗
2:	8.3	↓
3:	8.4	←
4:	9.3	↓
5:	9.9	←
Serie		44.0
Total		270.0

Hold	Skive	Lars Nøhr		
566	14			
50 meter afsnit 2		Stege Ndr. Skytteforening		
		SEN		
Landsstævne 2017		Aalborg Skyttekreds		
Prøve		1: 7.8 ↑ 2: 10.0 ↑ 3: 10.1 ↗ 4: 9.7 ← 5: 10.2 ↗ 6: 8.6 → 7: 10.5x ↗ 8: 10.6x ↑ Serie 74.0 Total 0.0	Ligg	 1: 10.2 ↗ 2: 10.1 ↗ 3: 9.5 → 4: 10.5x ← 5: 9.8 ↗ Serie 48.0 Total 48.0
Stå		1: 9.3 ← 2: 9.1 ↑ 3: 3.2 ↓ 4: 9.3 ↑ 5: 8.8 ← Serie 38.0 Total 86.0	Knæ	 1: 8.8 ← 2: 10.1 ← 3: 10.1 → 4: 9.3 → 5: 9.4 ← Serie 46.0 Total 132.0
Prøve		1: 8.7 → 2: 10.4 ← 3: 8.6 ↗ Serie 26.0 Total 132.0	3S+3K+4L	 1: 7.5 ↙ 2: 8.0 → 3: 8.4 ↑ 4: 8.3 → 5: 9.3 ↑ 6: 8.3 → 7: 10.2 ↓ 8: 8.5 → 9: 9.6 → 10: 10.8x ↗ Serie 85.0 Total 217.0
Stå		1: 7.7 → 2: 9.5 ↑ 3: 9.9 ↑ 4: 8.1 ← 5: 9.1 ← Serie 42.0 Total 259.0		

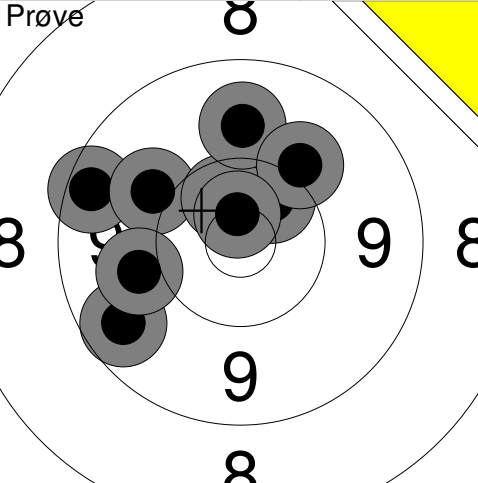
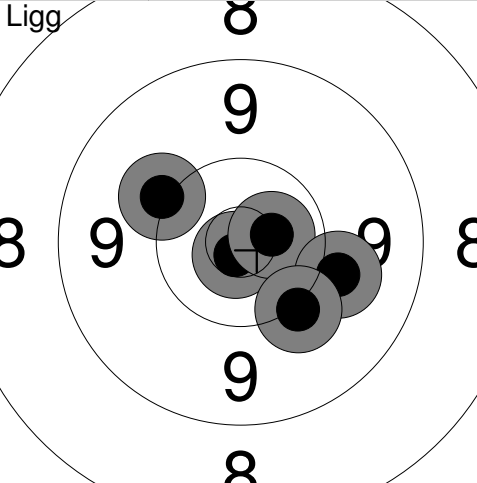
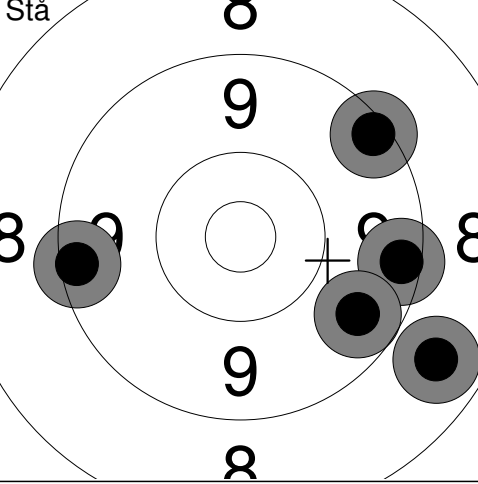
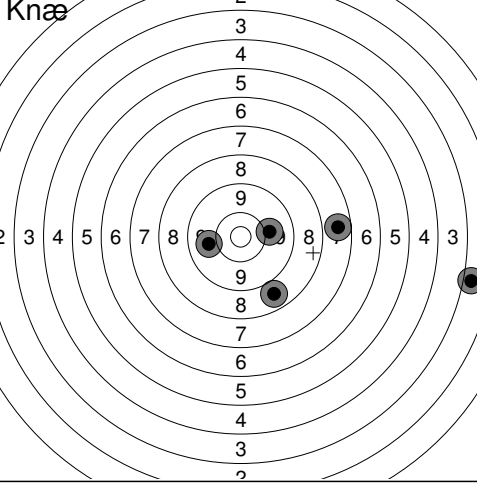
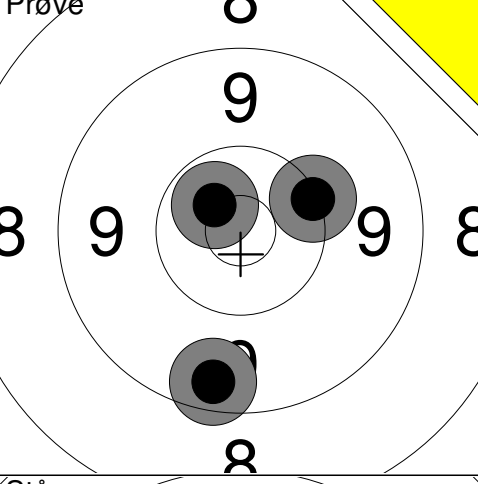
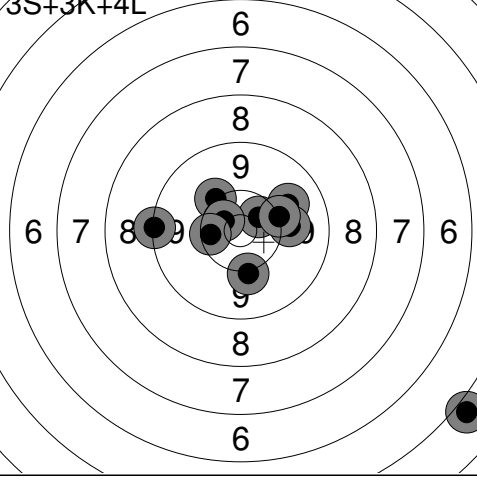
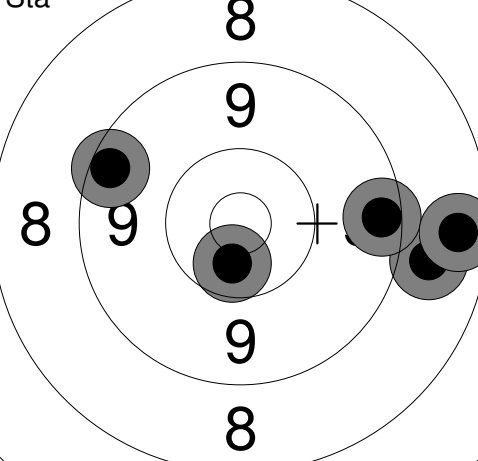
Hold	Skive	Eskil Gotfredsen	
566	15		
50 meter afsnit 2		Hvalsø Skytteforening	
		SEN	
		Landsstævne 2017	
		Aalborg Skyttekreds	
Prøve		1: 9.6 ↙ 2: 9.4 ↖ 3: 10.0 ↗ 4: 10.5x ↗ 5: 10.5x ↗ 6: 9.8 ↗ 7: 10.0 ↗ 8: 10.7x ↗ 9: 10.0 ←	Ligg
		Serie 87.0 Total 0.0	
			1: 10.1 ↗ 2: 10.8x ↓ 3: 10.7x → 4: 10.0 → 5: 10.1 ↓ Serie 50.0 Total 50.0
Stå		1: 9.4 → 2: 9.3 ↗ 3: 9.4 ← 4: 8.7 ↓ 5: 9.6 ↓	Knæ
		Serie 44.0 Total 94.0	
			1: 10.0 → 2: 9.9 ← 3: 8.7 ↓ 4: 2.9 → 5: 7.6 → Serie 36.0 Total 130.0
Prøve		1: 10.6x ↖ 2: 9.5 ↓ 3: 10.2 →	3S+3K+4L
		Serie 29.0 Total 130.0	
			1: 4.9 ↓ 2: 9.2 ← 3: 9.9 → 4: 10.0 → 5: 10.1 ↓ 6: 10.5x → 7: 10.2 ↗ 8: 10.6x ↖ 9: 10.4 ← 10: 10.2 → Serie 92.0 Total 222.0
Stå		1: 8.8 → 2: 9.4 → 3: 8.5 → 4: 9.4 ↖ 5: 10.5x ↓	
		Serie 44.0 Total 266.0	

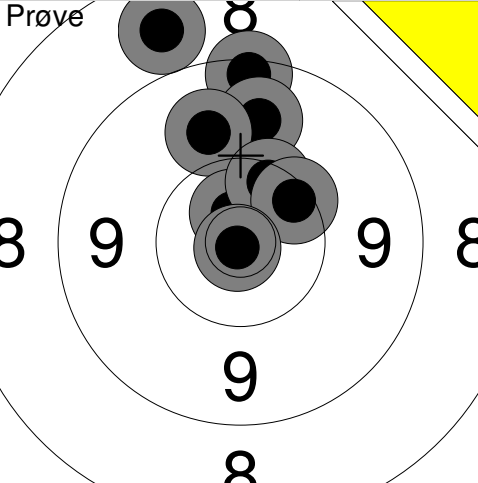
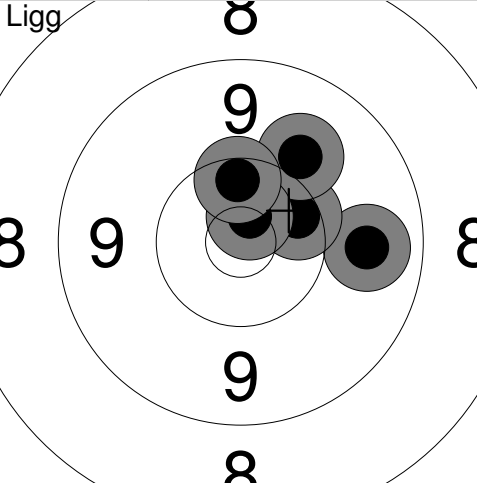
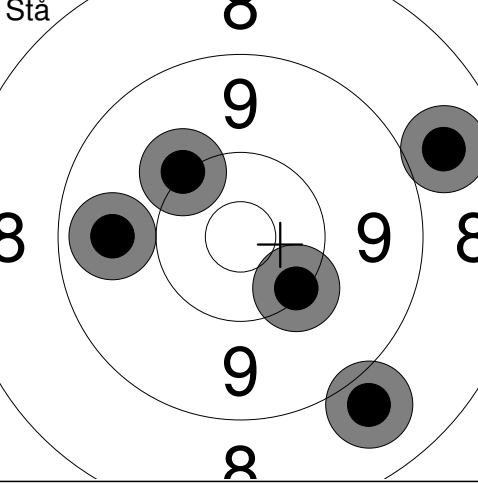
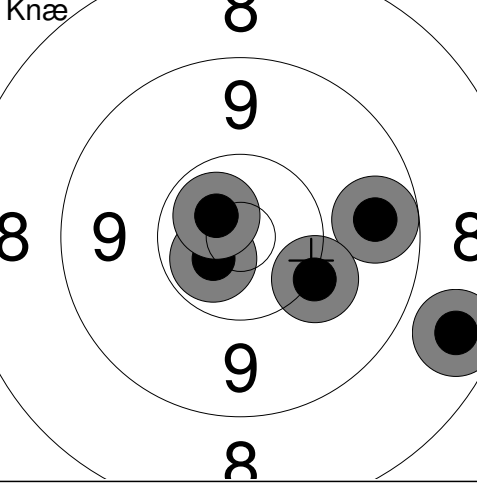
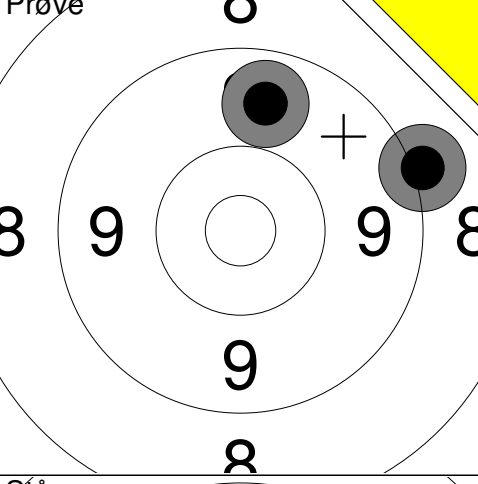
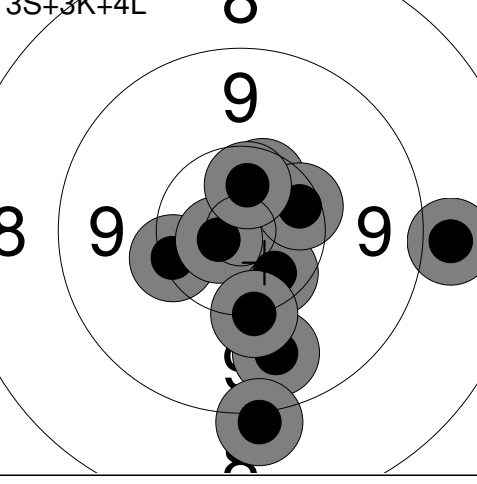
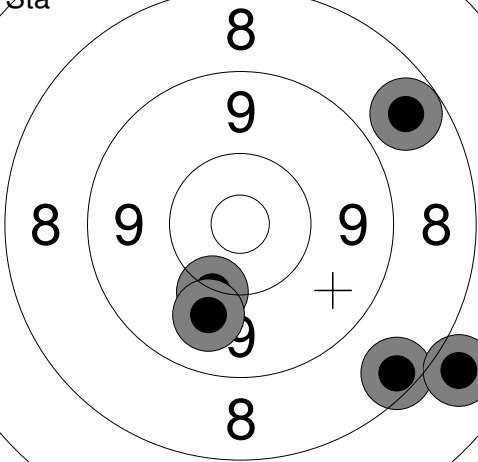
Hold	Skive	Michael Madsen	
566	16		
50 meter afsnit 2		Boddum-Ydby Skytteforening	
		SEN	
		Landsstævne 2017	Aalborg Skyttekreds
Prøve		1: 8.7 ↗ 2: 9.3 ↑ 3: 9.8 ↑ 4: 9.9 ↑ 5: 10.7x ↑ 6: 10.3 ↗ 7: 10.3 ↗ 8: 10.9x ↓	Ligg
		Serie 75.0 Total 0.0	
			1: 9.8 → 2: 10.4 ↗ 3: 10.0 ↗ 4: 10.7x ↑ 5: 10.4 ↑ Serie 49.0 Total 49.0
Stå		1: 10.2 ↓ 2: 8.9 ↓ 3: 9.7 ← 4: 8.8 → 5: 10.1 ↗	Knæ
		Serie 45.0 Total 94.0	
			1: 10.6x ↙ 2: 8.6 ↘ 3: 9.6 → 4: 10.1 ↘ 5: 10.6x ↗ Serie 47.0 Total 141.0
Prøve		1: 9.1 → 2: 9.7 ↑	3S+3K+4L
		Serie 18.0 Total 141.0	
			1: 8.9 → 2: 9.7 ↓ 3: 9.1 ↓ 4: 10.4x ↓ 5: 10.5x ↑ 6: 10.4 → 7: 10.3 ← 8: 10.7x ← 9: 10.2 ↓ 10: 10.5x ↑ Serie 96.0 Total 237.0
Stå		1: 8.6 ↗ 2: 10.1 ↓ 3: 8.4 ↓ 4: 7.9 ↓ 5: 9.9 ↓	
		Serie 42.0 Total 279.0	

<p>Prøve</p>	<table border="1" style="width:100%; border-collapse: collapse;"> <tr><td>1:</td><td>7.1</td><td>↘</td></tr> <tr><td>2:</td><td>8.8</td><td>↘</td></tr> <tr><td>3:</td><td>8.4</td><td>↘</td></tr> <tr><td>4:</td><td>9.8</td><td>↘</td></tr> <tr><td>5:</td><td>9.3</td><td>↘</td></tr> <tr><td>6:</td><td>10.0</td><td>↘</td></tr> <tr><td>7:</td><td>9.4</td><td>→</td></tr> <tr><td>8:</td><td>9.8</td><td>→</td></tr> <tr><td>9:</td><td>10.5x</td><td>↗</td></tr> <tr><td>10:</td><td>9.5</td><td>↗</td></tr> <tr><td colspan="2">Serie</td><td>88.0</td></tr> <tr><td colspan="2">Total</td><td>0.0</td></tr> </table>	1:	7.1	↘	2:	8.8	↘	3:	8.4	↘	4:	9.8	↘	5:	9.3	↘	6:	10.0	↘	7:	9.4	→	8:	9.8	→	9:	10.5x	↗	10:	9.5	↗	Serie		88.0	Total		0.0	<p>Prøve</p> <table border="1" style="width:100%; border-collapse: collapse;"> <tr><td>11:</td><td>10.0</td><td>↗</td></tr> <tr><td>12:</td><td>9.5</td><td>→</td></tr> <tr><td>13:</td><td>10.5x</td><td>→</td></tr> <tr><td>14:</td><td>10.6x</td><td>↘</td></tr> <tr><td>15:</td><td>10.6x</td><td>↗</td></tr> <tr><td>16:</td><td>10.6x</td><td>↘</td></tr> <tr><td colspan="2">Serie</td><td>59.0</td></tr> <tr><td colspan="2">Total</td><td>0.0</td></tr> </table>	11:	10.0	↗	12:	9.5	→	13:	10.5x	→	14:	10.6x	↘	15:	10.6x	↗	16:	10.6x	↘	Serie		59.0	Total		0.0
1:	7.1	↘																																																												
2:	8.8	↘																																																												
3:	8.4	↘																																																												
4:	9.8	↘																																																												
5:	9.3	↘																																																												
6:	10.0	↘																																																												
7:	9.4	→																																																												
8:	9.8	→																																																												
9:	10.5x	↗																																																												
10:	9.5	↗																																																												
Serie		88.0																																																												
Total		0.0																																																												
11:	10.0	↗																																																												
12:	9.5	→																																																												
13:	10.5x	→																																																												
14:	10.6x	↘																																																												
15:	10.6x	↗																																																												
16:	10.6x	↘																																																												
Serie		59.0																																																												
Total		0.0																																																												

<p>Ligg</p> <table border="1" style="width:100%; border-collapse: collapse;"> <tr><td>1:</td><td>9.2</td><td>↗</td></tr> <tr><td>2:</td><td>9.7</td><td>↗</td></tr> <tr><td>3:</td><td>10.2</td><td>↘</td></tr> <tr><td>4:</td><td>9.7</td><td>←</td></tr> <tr><td>5:</td><td>10.3</td><td>↗</td></tr> <tr><td colspan="2">Serie</td><td>47.0</td></tr> <tr><td colspan="2">Total</td><td>47.0</td></tr> </table>	1:	9.2	↗	2:	9.7	↗	3:	10.2	↘	4:	9.7	←	5:	10.3	↗	Serie		47.0	Total		47.0	<p>Stå</p> <table border="1" style="width:100%; border-collapse: collapse;"> <tr><td>1:</td><td>9.6</td><td>↘</td></tr> <tr><td>2:</td><td>8.1</td><td>↘</td></tr> <tr><td>3:</td><td>8.5</td><td>→</td></tr> <tr><td>4:</td><td>8.2</td><td>→</td></tr> <tr><td>5:</td><td>7.6</td><td>←</td></tr> <tr><td colspan="2">Serie</td><td>40.0</td></tr> <tr><td colspan="2">Total</td><td>87.0</td></tr> </table>	1:	9.6	↘	2:	8.1	↘	3:	8.5	→	4:	8.2	→	5:	7.6	←	Serie		40.0	Total		87.0
1:	9.2	↗																																									
2:	9.7	↗																																									
3:	10.2	↘																																									
4:	9.7	←																																									
5:	10.3	↗																																									
Serie		47.0																																									
Total		47.0																																									
1:	9.6	↘																																									
2:	8.1	↘																																									
3:	8.5	→																																									
4:	8.2	→																																									
5:	7.6	←																																									
Serie		40.0																																									
Total		87.0																																									

<p>Knæ</p> <table border="1" style="width:100%; border-collapse: collapse;"> <tr><td>1:</td><td>9.9</td><td>↗</td></tr> <tr><td>2:</td><td>10.5x</td><td>↑</td></tr> <tr><td>3:</td><td>8.7</td><td>↗</td></tr> <tr><td>4:</td><td>9.6</td><td>↘</td></tr> <tr><td>5:</td><td>9.3</td><td>↑</td></tr> <tr><td colspan="2">Serie</td><td>45.0</td></tr> <tr><td colspan="2">Total</td><td>132.0</td></tr> </table>	1:	9.9	↗	2:	10.5x	↑	3:	8.7	↗	4:	9.6	↘	5:	9.3	↑	Serie		45.0	Total		132.0	<p>Prøve</p> <table border="1" style="width:100%; border-collapse: collapse;"> <tr><td>1:</td><td>9.3</td><td>→</td></tr> <tr><td>2:</td><td>7.4</td><td>↖</td></tr> <tr><td>3:</td><td>9.9</td><td>↘</td></tr> <tr><td>4:</td><td>8.4</td><td>↗</td></tr> <tr><td>5:</td><td>5.5</td><td>→</td></tr> <tr><td>6:</td><td>7.5</td><td>←</td></tr> <tr><td>7:</td><td>10.5x</td><td>→</td></tr> <tr><td colspan="2">Serie</td><td>55.0</td></tr> <tr><td colspan="2">Total</td><td>132.0</td></tr> </table>	1:	9.3	→	2:	7.4	↖	3:	9.9	↘	4:	8.4	↗	5:	5.5	→	6:	7.5	←	7:	10.5x	→	Serie		55.0	Total		132.0
1:	9.9	↗																																															
2:	10.5x	↑																																															
3:	8.7	↗																																															
4:	9.6	↘																																															
5:	9.3	↑																																															
Serie		45.0																																															
Total		132.0																																															
1:	9.3	→																																															
2:	7.4	↖																																															
3:	9.9	↘																																															
4:	8.4	↗																																															
5:	5.5	→																																															
6:	7.5	←																																															
7:	10.5x	→																																															
Serie		55.0																																															
Total		132.0																																															

<p>3S+3K+4L</p> <table border="1" style="width:100%; border-collapse: collapse;"> <tr><td>1:</td><td>10.5x</td><td>→</td></tr> <tr><td>2:</td><td>8.8</td><td>↖</td></tr> <tr><td>3:</td><td>10.5x</td><td>←</td></tr> <tr><td>4:</td><td>9.6</td><td>↗</td></tr> <tr><td>5:</td><td>8.7</td><td>→</td></tr> <tr><td>6:</td><td>7.3</td><td>→</td></tr> <tr><td>7:</td><td>9.4</td><td>↘</td></tr> <tr><td>8:</td><td>10.1</td><td>↑</td></tr> <tr><td>9:</td><td>9.6</td><td>↗</td></tr> <tr><td>10:</td><td>9.9</td><td>↗</td></tr> <tr><td colspan="2">Serie</td><td>89.0</td></tr> <tr><td colspan="2">Total</td><td>221.0</td></tr> </table>	1:	10.5x	→	2:	8.8	↖	3:	10.5x	←	4:	9.6	↗	5:	8.7	→	6:	7.3	→	7:	9.4	↘	8:	10.1	↑	9:	9.6	↗	10:	9.9	↗	Serie		89.0	Total		221.0	<p>Stå</p> <table border="1" style="width:100%; border-collapse: collapse;"> <tr><td>1:</td><td>9.3</td><td>←</td></tr> <tr><td>2:</td><td>10.3</td><td>←</td></tr> <tr><td>3:</td><td>9.5</td><td>↗</td></tr> <tr><td>4:</td><td>7.2</td><td>↘</td></tr> <tr><td>5:</td><td>8.2</td><td>→</td></tr> <tr><td colspan="2">Serie</td><td>43.0</td></tr> <tr><td colspan="2">Total</td><td>264.0</td></tr> </table>	1:	9.3	←	2:	10.3	←	3:	9.5	↗	4:	7.2	↘	5:	8.2	→	Serie		43.0	Total		264.0
1:	10.5x	→																																																								
2:	8.8	↖																																																								
3:	10.5x	←																																																								
4:	9.6	↗																																																								
5:	8.7	→																																																								
6:	7.3	→																																																								
7:	9.4	↘																																																								
8:	10.1	↑																																																								
9:	9.6	↗																																																								
10:	9.9	↗																																																								
Serie		89.0																																																								
Total		221.0																																																								
1:	9.3	←																																																								
2:	10.3	←																																																								
3:	9.5	↗																																																								
4:	7.2	↘																																																								
5:	8.2	→																																																								
Serie		43.0																																																								
Total		264.0																																																								

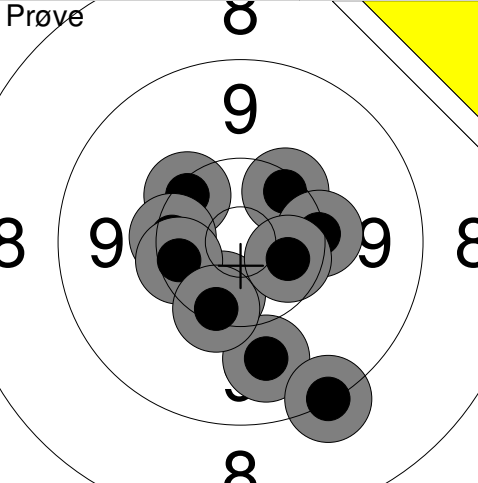
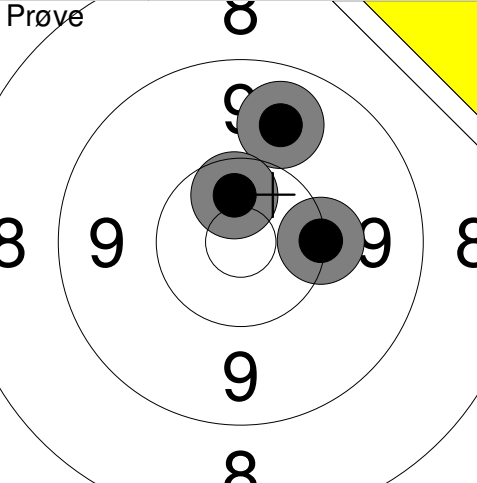
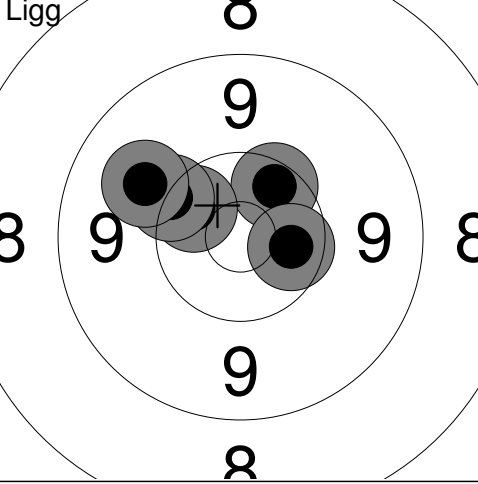
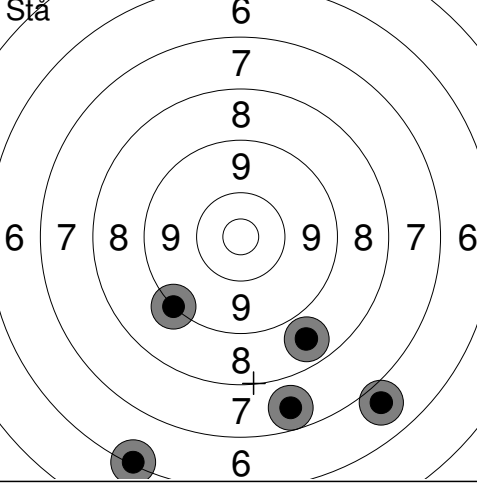
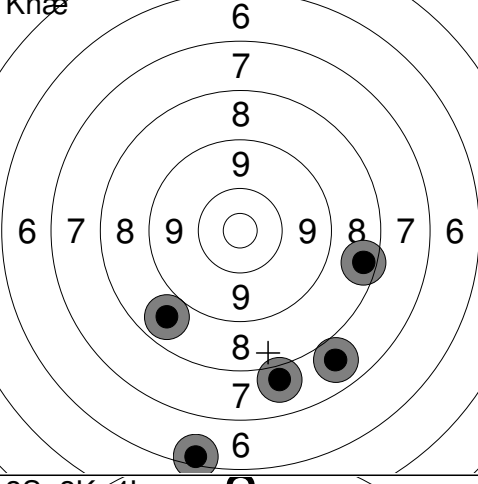
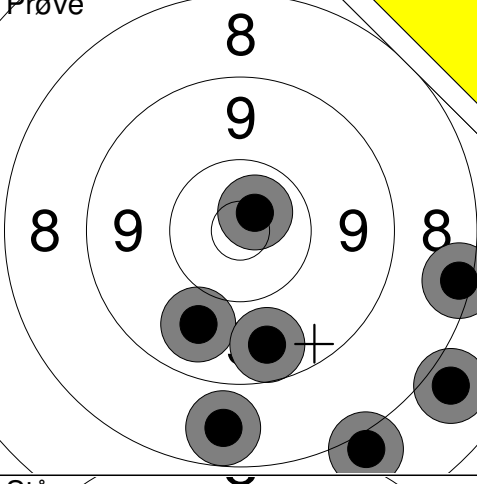
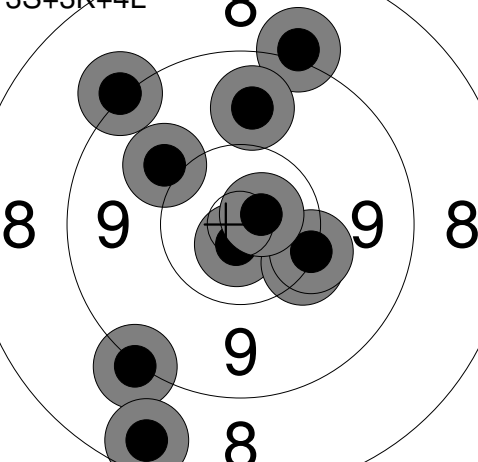
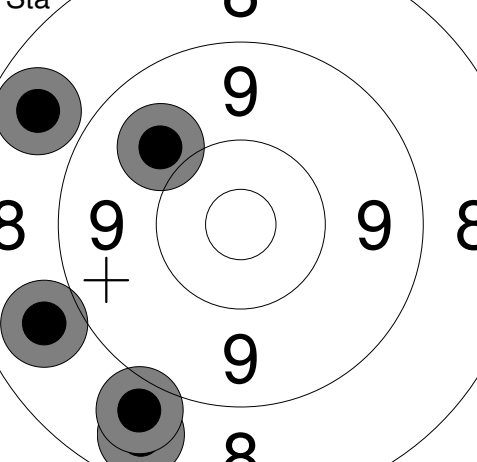
Hold	Skive	Stine Jensen			
566	18				
50 meter afsnit 2		Samsø Skytteforening			
		SEN			
		Landsstævne 2017			
		Aalborg Skyttekreds			
Prøve		1: 9.8 ↓ 2: 10.3 ↑ 3: 10.3 ← 4: 10.4x ↓ 5: 10.3 ↑ 6: 10.3 ← 7: 9.2 ↓ 8: 10.2 → 9: 10.3 ↓ 10: 10.5x ↓	Prøve		11: 10.2 → 12: 9.8 ↑ 13: 10.5x ↑
		Serie 98.0		Serie 29.0	
		Total 0.0		Total 0.0	
Ligg		1: 10.4 ↑ 2: 10.4x ↑ 3: 10.2 ↑ 4: 9.9 ↑ 5: 10.5x →	Stå		1: 6.8 ↓ 2: 6.2 ↓ 3: 7.6 ↓ 4: 9.2 ↓ 5: 8.7 ↓
		Serie 49.0		Serie 36.0	
		Total 49.0		Total 85.0	
Knæ		1: 7.8 ↓ 2: 6.3 ↓ 3: 7.9 ↓ 4: 8.4 → 5: 8.7 ↓	Prøve		1: 8.0 ↓ 2: 10.7x ↑ 3: 7.9 ↓ 4: 9.8 ↓ 5: 8.6 ↓ 6: 8.3 → 7: 9.6 ↓
		Serie 36.0		Serie 59.0	
		Total 121.0		Total 121.0	
3S+3K+4L		1: 10.7x ↓ 2: 9.1 ↑ 3: 10.2 ↓ 4: 10.2 ↓ 5: 9.1 ↓ 6: 8.5 ↓ 7: 10.7x → 8: 9.1 ↑ 9: 9.8 ↑ 10: 10.0 ↑	Stå		1: 8.8 ← 2: 8.7 ↑ 3: 9.9 ↑ 4: 8.7 ↓ 5: 8.9 ↓
		Serie 94.0		Serie 41.0	
		Total 215.0		Total 256.0	

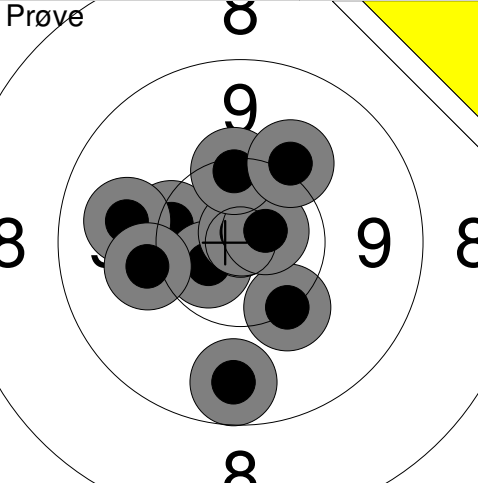
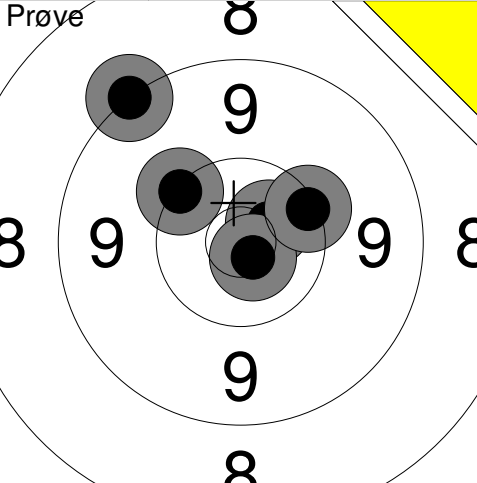
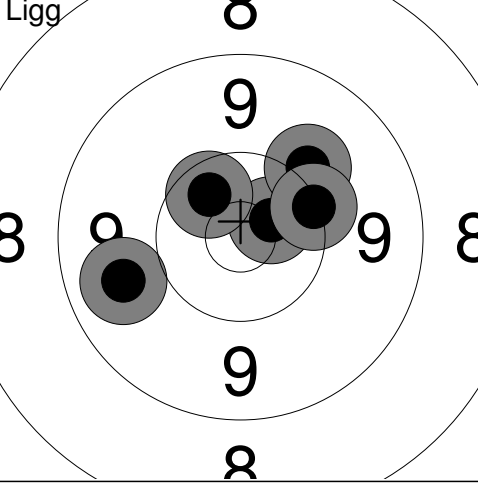
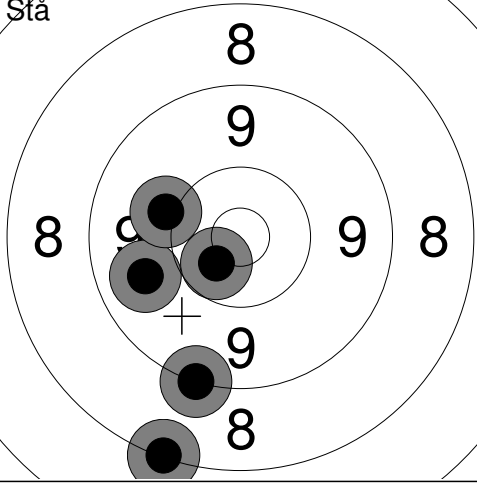
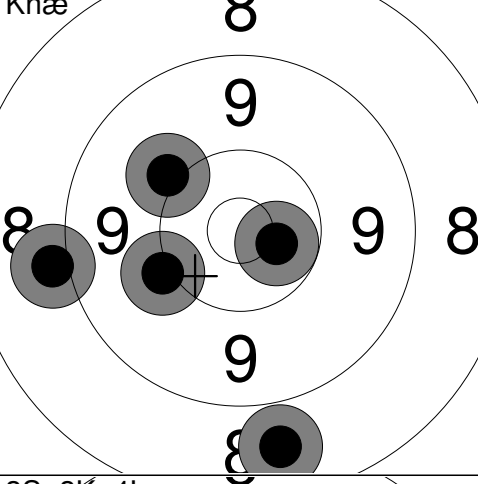
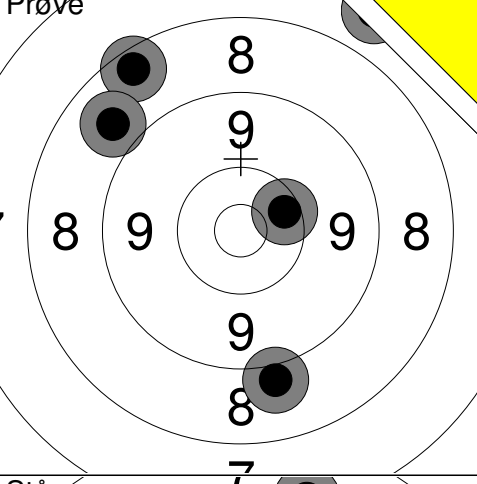
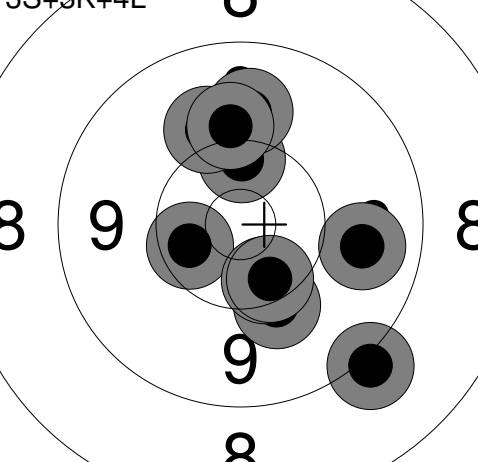
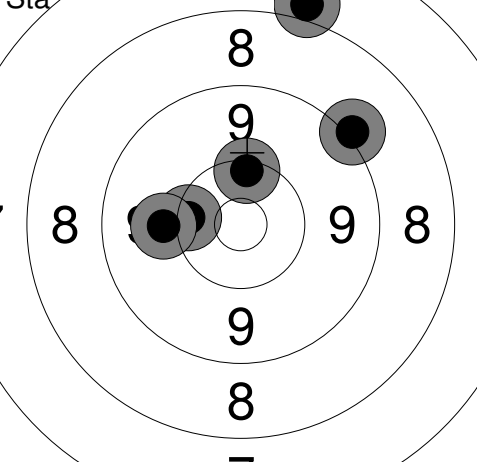

Hold	Skive	Peter Hansen			
566	19	50 meter afsnit 2			
Landsstævne 2017		Aalborg Skyttekreds			
Stege Ndr. Skytteforening		SEN			
Prøve		1: 10.3 ← 2: 10.2 ↓ 3: 10.6x ← 4: 10.9x ↑ 5: 10.7x → 6: 9.9 ← 7: 10.0 ← 8: 9.6 ↓ 9: 10.3 ↑ 10: 10.1 ↗ Serie 98.0 Total 0.0	Prøve		11: 10.6x ↗ 12: 10.8x ↓ 13: 10.2 → 14: 10.2 ↗ 15: 9.2 ↗ Serie 49.0 Total 0.0
Ligg		1: 10.6x → 2: 10.5x ↗ 3: 10.0 ↗ 4: 10.2 → 5: 9.8 ← Serie 49.0 Total 49.0	Stå		1: 9.8 ← 2: 9.2 ↓ 3: 10.5x ↓ 4: 10.1 ← 5: 8.2 ↓ Serie 46.0 Total 95.0
Knæ		1: 8.7 ↓ 2: 10.1 ↗ 3: 9.0 ← 4: 10.1 ← 5: 10.6x → Serie 47.0 Total 142.0	Prøve		1: 9.0 ↓ 2: 8.4 ↗ 3: 10.4 → 4: 7.6 ↗ 5: 8.8 ↗ Serie 42.0 Total 142.0
3S+3K+4L		1: 10.3 ↑ 2: 9.9 ↑ 3: 10.0 ↗ 4: 9.1 ↓ 5: 10.1 ↓ 6: 9.8 → 7: 10.4x ← 8: 10.4 ↓ 9: 10.4 ↓ 10: 10.0 ↑ Serie 97.0 Total 239.0	Stå		1: 10.3 ↑ 2: 8.0 ↑ 3: 9.1 ↗ 4: 10.3 ← 5: 10.0 ← Serie 47.0 Total 286.0

<b>Prøve</b> 	1: 9.2 → 2: 7.9 → 3: 10.2 ↗ 4: 9.3 → 5: 9.9 ← 6: 10.2 ← 7: 10.6x ↓ 8: 10.5x ↙ 9: 10.3 ← 10: 8.2 ←	<b>Prøve</b> 	11: 9.0 ↙ 12: 8.3 ↙
	Serie 92.0 Total 0.0		Serie 17.0 Total 0.0

<b>Ligg</b> 	1: 10.1 ← 2: 9.6 ↘ 3: 9.8 → 4: 9.8 ↗ 5: 9.2 ↗	<b>Stå</b> 	1: 9.3 → 2: 7.0 ↗ 3: 9.4 ↗ 4: 8.3 ↘ 5: 6.0 ↗
	Serie 46.0 Total 46.0		Serie 39.0 Total 85.0

<b>Knæ</b> 	1: 8.8 ↗ 2: 8.6 ← 3: 10.0 ↗ 4: 8.9 ↗ 5: 10.1 ←	<b>Prøve</b> 	1: 8.0 → 2: 9.5 ↘ 3: 8.9 ↗ 4: 9.5 ↗ 5: 8.6 ↗
	Serie 44.0 Total 129.0		Serie 42.0 Total 129.0

<b>3S+3K+4L</b> 	1: 9.8 ↗ 2: 8.0 ↗ 3: 8.2 ↘ 4: 6.2 ← 5: 10.7x ← 6: 10.0 → 7: 9.4 ← 8: 8.9 ← 9: 7.8 ↘ 10: 8.2 ←	<b>Stå</b> 	1: 7.4 ← 2: 9.3 ← 3: 9.5 ← 4: 9.4 ↗ 5: 7.7 ↘
	Serie 83.0 Total 212.0		Serie 41.0 Total 253.0

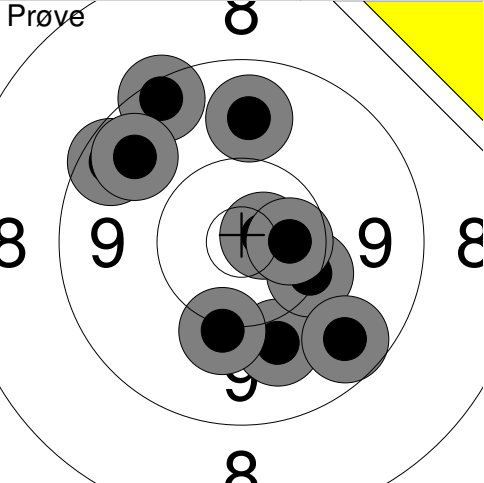
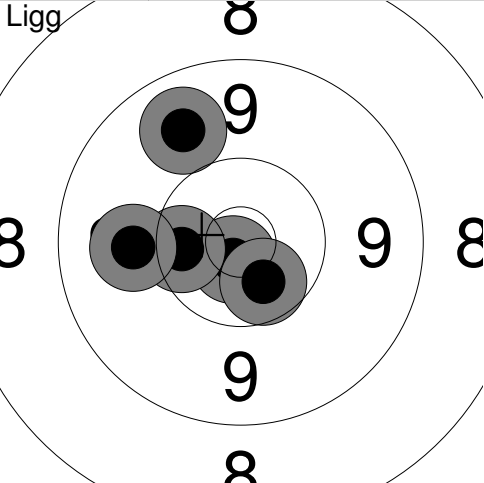
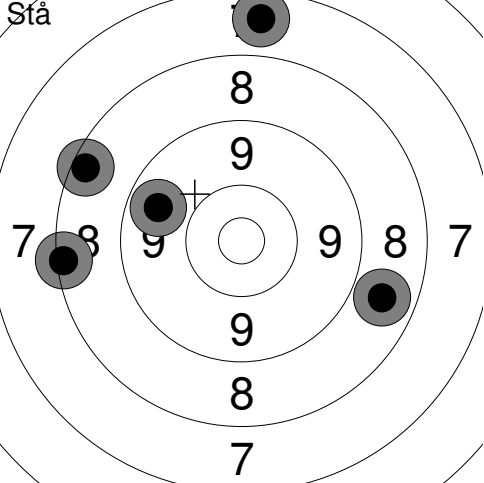
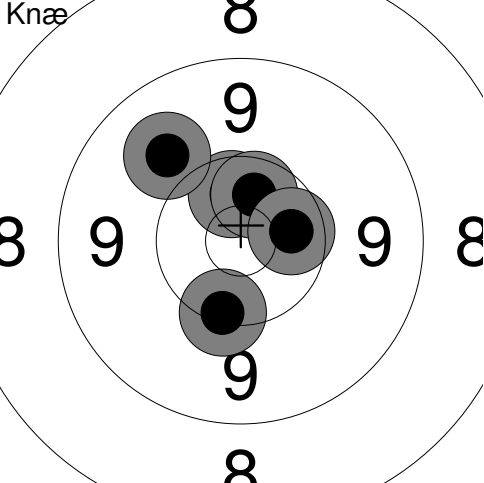
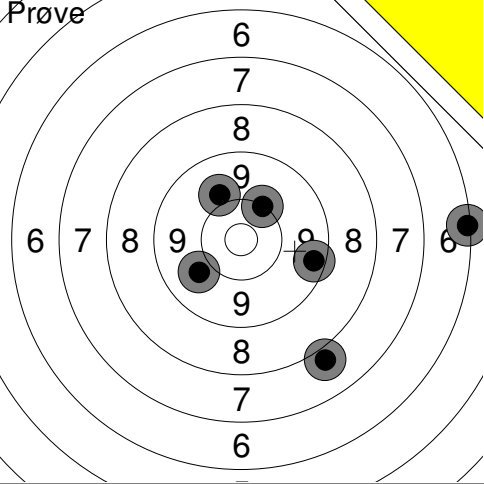
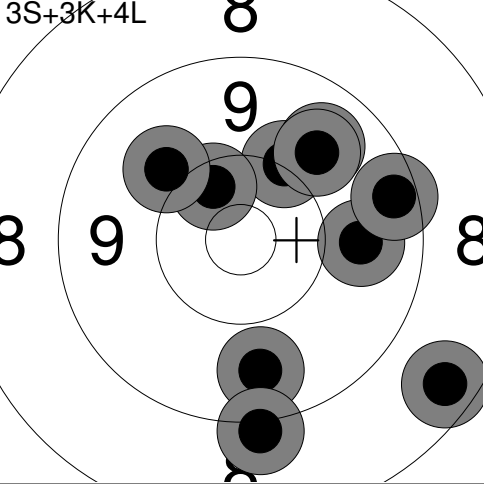
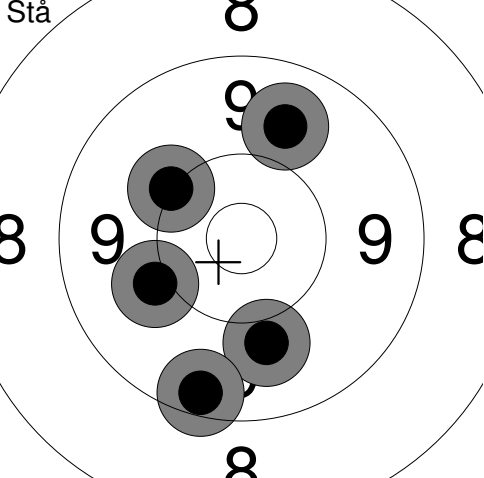
Hold	Skive	Frederikke Frederiksen			
567	13	Frederikke Frederiksen			
50 meter afsnit 2		Damsholte Skytteforening			
		SEN			
		Landsstævne 2017			
		Aalborg Skyttekreds			
Prøve		1: 9.8 ↑ 2: 9.4 ↗ 3: 9.5 ↗ 4: 9.6 ↗ 5: 9.9 ↓ 6: 10.1 ↓ 7: 10.7x → 8: 10.2 ↓ 9: 10.5x → 10: 9.6 ↓ Serie 94.0 Total 0.0	Ligg		1: 10.8x ↓ 2: 9.8 ↗ 3: 10.4 ← 4: 9.9 ← 5: 10.5x ↓ Serie 48.0 Total 48.0
Stå		1: 8.3 ← 2: 9.7 ↗ 3: 8.4 ↗ 4: 7.6 ↑ 5: 8.7 → Serie 40.0 Total 88.0	Knæ		1: 10.5x ↑ 2: 9.9 ↗ 3: 10.5x ↑ 4: 10.3 ↓ 5: 10.5x → Serie 49.0 Total 137.0
Prøve		1: 9.9 ↙ 2: 9.4 → 3: 10.0 ↗ 4: 7.9 ↓ 5: 6.2 → 6: 10.2 ↗ Serie 51.0 Total 137.0	3S+3K+4L		1: 8.5 ↘ 2: 9.7 ↓ 3: 10.1 ↗ 4: 9.1 ↓ 5: 9.8 → 6: 9.4 → 7: 10.4 ↗ 8: 9.8 ↗ 9: 9.9 ↗ 10: 10.0 ↖ Serie 92.0 Total 229.0
Stå		1: 10.0 ← 2: 10.1 ↗ 3: 9.8 ↗ 4: 9.9 ↓ 5: 9.4 ↓ Serie 47.0 Total 276.0			

<p>Prøve</p>	<p>1: 5.6 ↑</p> <p>2: 8.2 ↗</p> <p>3: 8.7 ↗</p> <p>4: 8.3 ↑</p> <p>5: 9.6 ↑</p> <p>6: 8.5 ↘</p> <p>7: 8.9 ↘</p> <p>8: 10.4 →</p> <p>9: 9.7 ↗</p> <p>10: 9.8 ↘</p> <hr/> <p>Serie 82.0</p> <p>Total 0.0</p>	<p>Prøve</p> <p>11: 8.7 ←</p> <hr/> <p>Serie 8.0</p> <p>Total 0.0</p>
--------------	--	---

<p>Ligg</p>	<p>1: 10.5x →</p> <p>2: 9.8 ↘</p> <p>3: 10.4 ↘</p> <p>4: 10.6x ↗</p> <p>5: 9.9 ↘</p> <hr/> <p>Serie 48.0</p> <p>Total 48.0</p>	<p>Stå</p> <p>1: 6.1 ↓</p> <p>2: 6.4 →</p> <p>3: 9.9 ↘</p> <p>4: 6.4 ↘</p> <p>5: 9.9 ↗</p> <hr/> <p>Serie 36.0</p> <p>Total 84.0</p>
-------------	--	--

<p>Knæ</p>	<p>1: 9.5 ↓</p> <p>2: 8.6 ↘</p> <p>3: 10.3 ←</p> <p>4: 9.0 ↘</p> <p>5: 10.6x ↓</p> <hr/> <p>Serie 46.0</p> <p>Total 130.0</p>	<p>Prøve</p> <p>1: 7.6 ↘</p> <p>2: 9.2 ←</p> <p>3: 10.1 ←</p> <p>4: 7.1 ↘</p> <p>5: 10.0 ↓</p> <p>6: 5.4 →</p> <hr/> <p>Serie 48.0</p> <p>Total 130.0</p>
------------	---	---

<p>3S+3K+4L</p>	<p>1: 7.6 ↘</p> <p>2: 7.0 →</p> <p>3: 8.4 →</p> <p>4: 8.9 ↗</p> <p>5: 8.7 →</p> <p>6: 8.7 ←</p> <p>7: 9.9 ↗</p> <p>8: 8.5 ↘</p> <p>9: 8.8 ↗</p> <p>10: 10.0 ↗</p> <hr/> <p>Serie 81.0</p> <p>Total 211.0</p>	<p>Stå</p> <p>1: 5.0 →</p> <p>2: 9.8 →</p> <p>3: 8.3 ↗</p> <p>4: 6.3 →</p> <p>5: 6.9 →</p> <hr/> <p>Serie 34.0</p> <p>Total 245.0</p>
-----------------	--	---

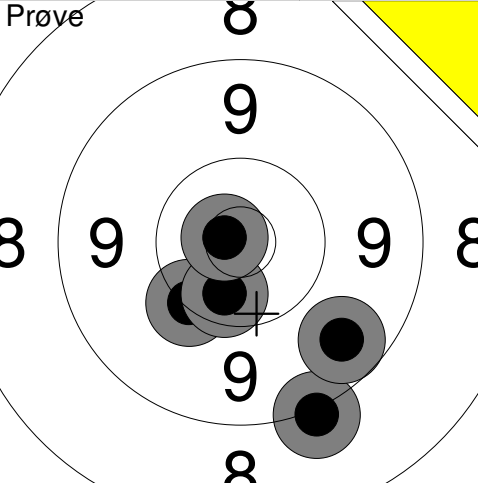
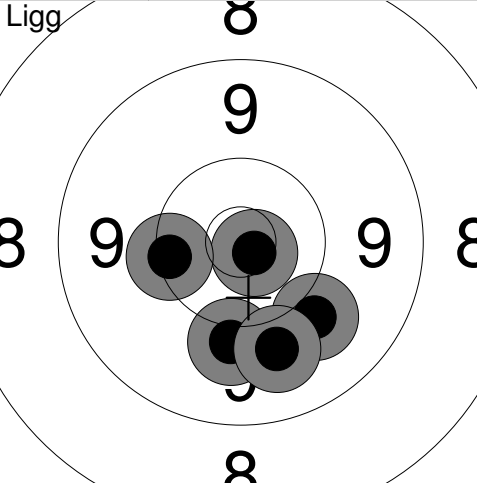
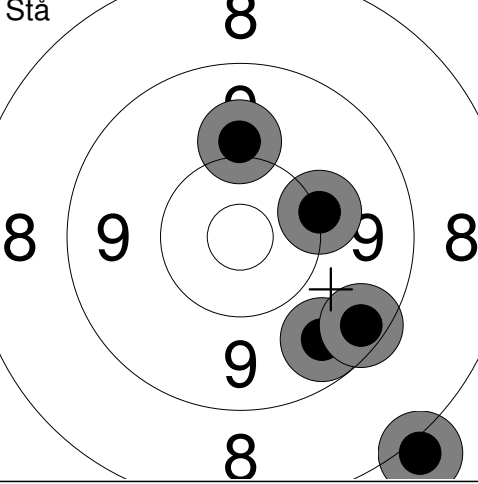
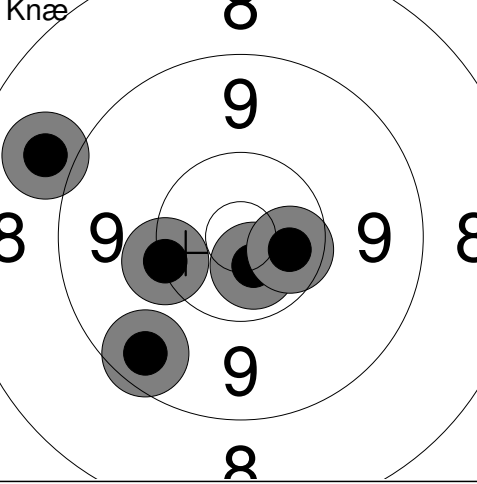
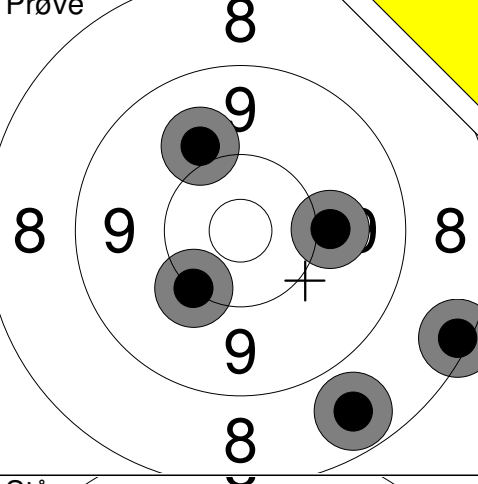
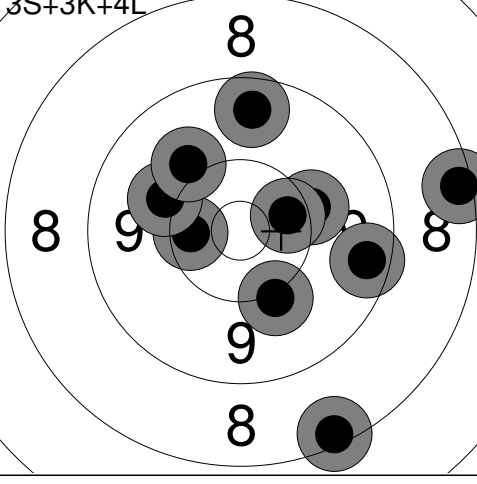
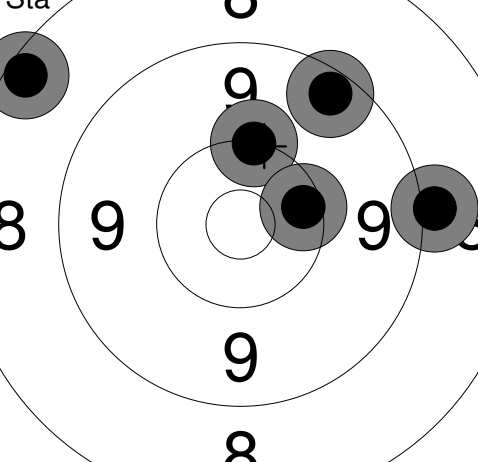
Hold	Skive	Claus P V Jensen	
567	15		
50 meter afsnit 2		Samsø Skytteforening	
		SEN	
		Landsstævne 2017	
		Aalborg Skyttekreds	
Prøve		1: 9.1 ↘ 2: 9.6 ↘ 3: 10.2 ↘ 4: 10.4x ↘ 5: 10.8x ←	Ligg
		Serie 48.0	
		Total 0.0	1: 10.0 ↘ 2: 10.0 ↘ 3: 10.8x ↘ 4: 9.9 ↘ 5: 10.3 ←
			Serie 49.0
			Total 49.0
Stå		1: 8.0 ↘ 2: 9.6 ↘ 3: 9.4 ↘ 4: 10.0 ↑ 5: 10.1 →	Knæ
		Serie 46.0	
		Total 95.0	1: 10.2 ← 2: 8.9 ↗ 3: 10.7x ↘ 4: 10.5x → 5: 9.5 ↘
			Serie 47.0
			Total 142.0
Prøve		1: 10.0 ↗ 2: 10.0 → 3: 8.6 ↘ 4: 8.3 ↘ 5: 10.2 ↘	3S+3K+4L
		Serie 46.0	
		Total 142.0	1: 9.5 → 2: 8.3 ↘ 3: 8.3 → 4: 10.1 → 5: 9.6 ↑ 6: 10.4 → 7: 10.1 ↘ 8: 10.4 ← 9: 10.0 ↗ 10: 10.0 ↗
			Serie 94.0
			Total 236.0
Stå		1: 9.0 → 2: 10.2 ↑ 3: 10.3 → 4: 9.4 ↗ 5: 8.4 ↗	
		Serie 46.0	
		Total 282.0	

Hold	Skive	Erik Madsen	
567	16	Erik Madsen	
50 meter afsnit 2		Karup Skytteforening af 1889	
		SEN	
		Landsstævne 2017	
		Aalborg Skyttekreds	
Prøve		Ligg	
Stå		Knæ	
Prøve		3S+3K+4L	
Stå			

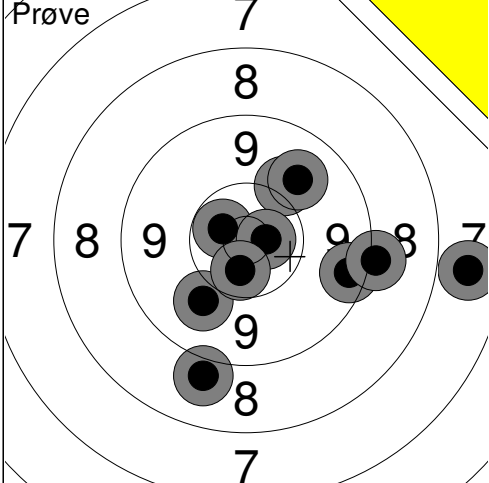

1:	7.7	→
2:	9.9	↘
3:	8.9	↘
4:	10.0	↗
5:	9.9	↗
6:	10.6x	↗
7:	10.7x	→
8:	9.4	↘
9:	9.1	→
10:	10.5x	↘
Serie		91.0
Total		0.0

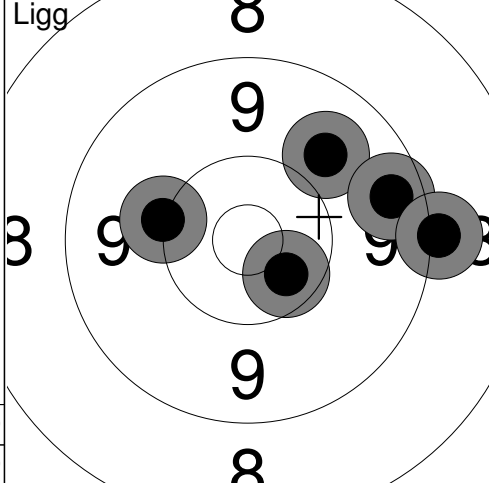

1:	9.9	↗
2:	10.5x	↘
3:	9.5	→
4:	10.1	←
5:	9.1	→
Serie		47.0
Total		47.0

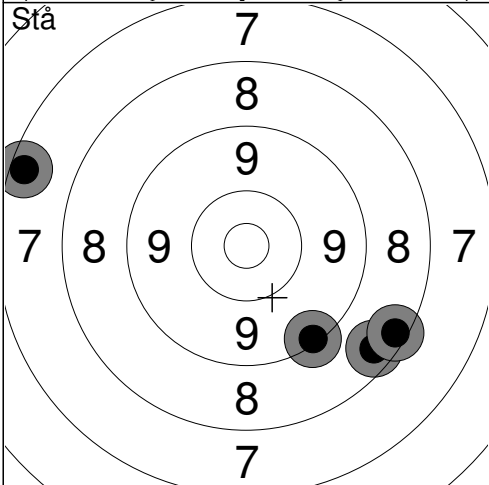

1:	7.4	←
2:	8.5	↘
3:	8.4	↘
4:	9.3	↘
Serie		32.0
Total		79.0

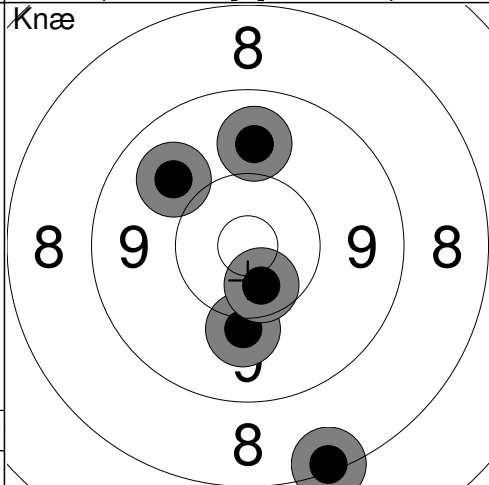

1:	9.8	↑
2:	9.8	↗
3:	10.0	↘
4:	8.3	↘
5:	10.5x	↘
Serie		46.0
Total		125.0

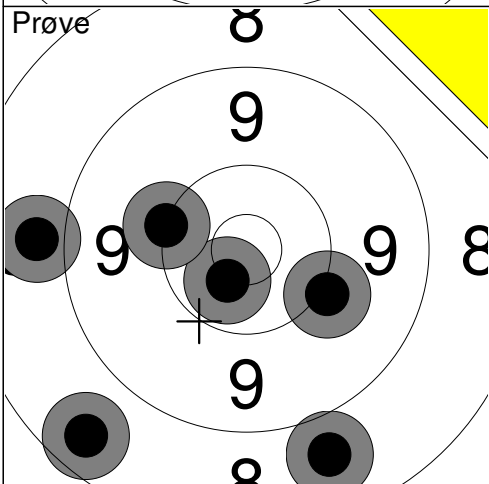

1:	10.6x	↘
2:	10.2	←
3:	10.1	↘
4:	8.9	←
5:	8.8	↘
6:	8.5	↘
Serie		54.0
Total		125.0

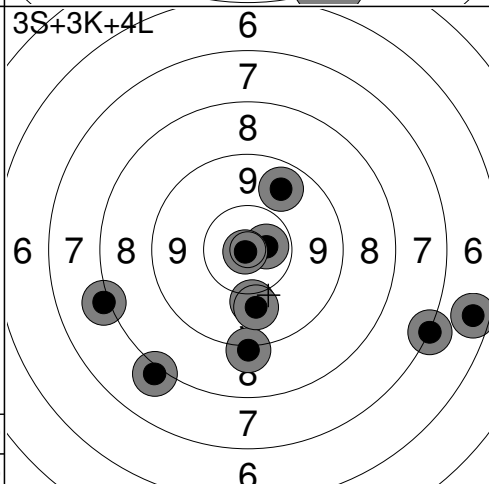

1:	6.5	→
2:	8.1	←
3:	7.2	↘
4:	10.0	↘
5:	9.7	↗
6:	8.0	↘
7:	9.1	↘
8:	9.9	↘
9:	10.6x	→
10:	10.9x	↘
Serie		86.0
Total		211.0

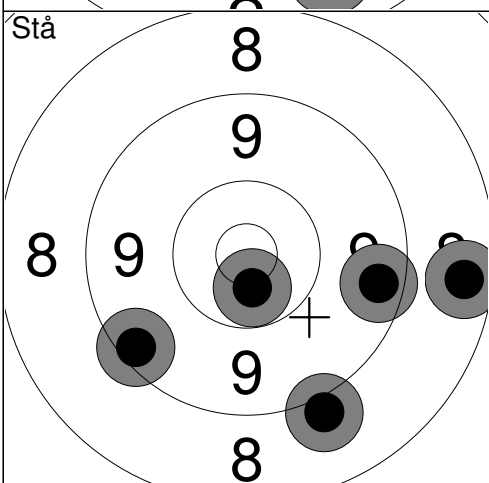

1:	9.5	→
2:	9.0	↘
3:	10.6x	↘
4:	8.5	→
5:	9.4	↘
Serie		45.0
Total		256.0

Hold	Skive	Louise Nøhr	
567	19		
50 meter afsnit 2		Stege Ndr. Skytteforening	
		SEN	
Landsstævne 2017		Aalborg Skyttekreds	
<b>Prøve</b> 	1: 8.7 ↓ 2: 9.8 ↓ 3: 7.4 ↓ 4: 10.0 ↑ 5: 10.1 →	<b>Ligg</b> 	1: 9.7 ↓ 2: 9.5 ↗ 3: 10.6x ← 4: 8.5 ↓ 5: 9.0 ↓
	Serie 44.0		Serie 45.0
	Total 0.0		Total 45.0
<b>Stå</b> 	1: 10.6x ↓ 2: 10.1 ↗ 3: 8.0 ↓ 4: 10.1 → 5: 10.7x ←	<b>Knæ</b> 	1: 8.7 ↗ 2: 7.2 ← 3: 8.7 ↓ 4: 10.2 ← 5: 8.2 →
	Serie 48.0		Serie 41.0
	Total 93.0		Total 134.0
<b>Prøve</b> 	1: 8.8 → 2: 7.0 ← 3: 9.5 ← 4: 9.0 ↓ 5: 7.8 ↓ 6: 7.4 →	<b>3S+3K+4L</b> 	1: 9.2 → 2: 9.2 ← 3: 9.4 ← 4: 7.2 ↗ 5: 9.6 ↓ 6: 6.5 ← 7: 9.8 ↑ 8: 9.2 ← 9: 10.3 → 10: 10.1 ↓
	Serie 47.0		Serie 87.0
	Total 134.0		Total 221.0
<b>Stå</b> 	1: 7.8 ↑ 2: 6.7 ↓ 3: 7.9 ↓ 4: 8.0 ↑ 5: 8.5 ↘		
	Serie 36.0		
	Total 257.0		